

MV70 MV71 MV72 MV73

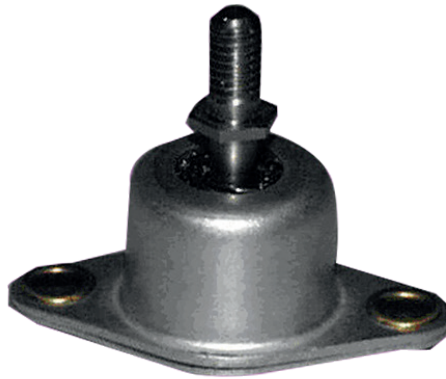

Natural frequency : (1)
axial and radial 15 to 25 Hz

DESCRIPTION

All metal mount design to carry load in compression or tension and which includes an internal limit stop.

APPLICATIONS

Protection of components, assemblies and electronic equipment mounted in aircraft, road vehicles and trains including navigation equipment, control consoles, measuring instruments.

TECHNICAL CHARACTERISTICS

- Max permitted excitation at natural frequency :
MV70 : $\pm 0,3$ mm.
MV71 : $\pm 0,4$ mm.
MV72 : $\pm 0,45$ mm.
MV73 : $\pm 0,45$ mm.
- Amplification factor at resonance : < 4 .
- Operating temperature : $- 70$ °C to $+ 300$ °C.
- Structural strength corresponds to continuous acceleration of 10g with maximum load
- Internal snubber design for equivalent performance during continuous acceleration at maximum load.

MV70

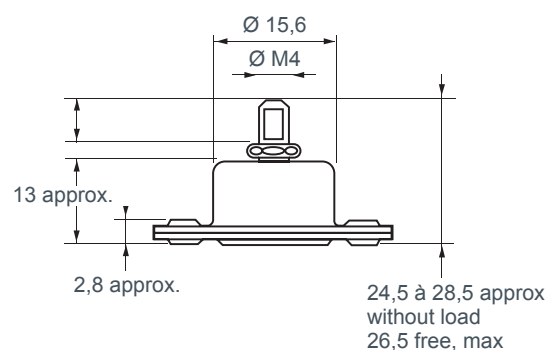
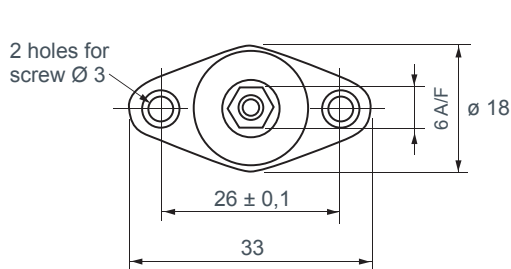

Reference	Static axial load (daN)	Natural frequency
MV70-01	0,05 - 0,20	20 to 25 Hz
MV70-02	0,15 - 0,35	
MV70-03	0,30 - 0,65	
MV70-04	0,50 - 0,85	
MV70-05	0,75 - 1,00	

(1) Natural frequencies with max/min loads, see : OPERATING CHARACTERISTICS.

MV71

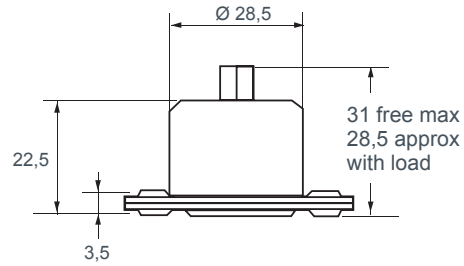
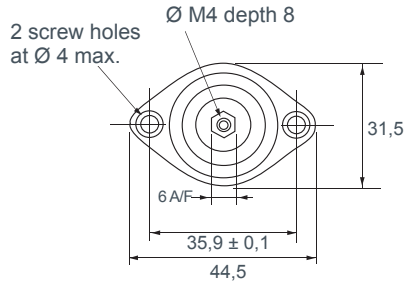

Reference	Static axial load (daN)	Natural frequency
MV71-01	0,18 - 0,50	15 to 20 Hz
MV71-02	0,30 - 0,70	
MV71-03	0,45 - 0,90	
MV71-04	0,65 - 1,30	
MV71-05	0,90 - 1,80	
MV71-06	1,35 - 2,40	
MV71-07	1,80 - 3,00	

MV72

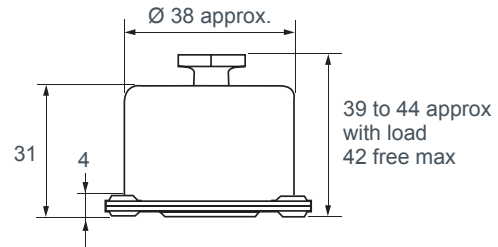
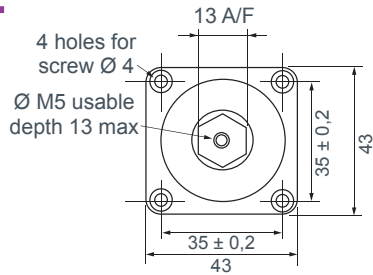

Reference	Static axial load (daN)	Natural frequency
MV72-P03	0,30 - 0,55	15 to 20 Hz
MV72-P04	0,50 - 0,90	
MV72-P05	0,75 - 1,40	
MV72-P06	1,20 - 2,10	
MV72-P07	1,90 - 3,40	
MV72-P08	3,00 - 5,90	
MV72-P09	4,20 - 8,20	
MV72-P10	5,90 - 11,50	

MV73

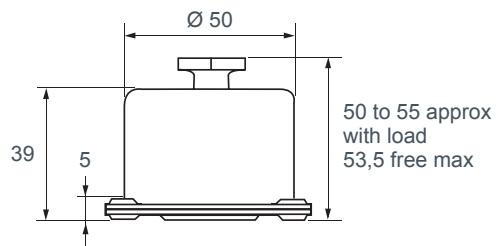
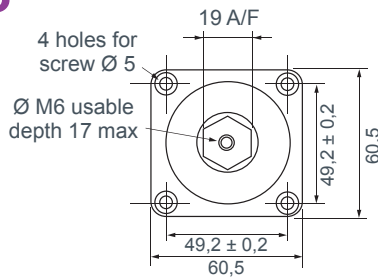

Reference	Static axial load (daN)	Natural frequency
MV73-P02	2,50 - 5,20	15 to 20 Hz
MV73-P03	3,50 - 8,00	
MV73-P04	4,50 - 10,00	
MV73-P05	5,50 - 12,00	
MV73-P06	7,00 - 14,00	
MV73-P07	9,00 - 16,00	
MV73-P08	10,50 - 19,00	
MV73-P09	12,00 - 22,00	
MV73-P10	15,00 - 27,00	

(1) Natural frequencies with max/min loads, see : OPERATING CHARACTERISTICS.