

Lloyd's Register

IMQ

Tensione massima	250 Vca	Max. voltage	250 Vac
Intensità di corrente	6 (2) A	Current	6 (2) A
Contatti elettrici in scambio	SPDT	C/O contacts	SPDT
Differenziale regolabile	10% ÷ 30% del valore di taratura	Adjustable hysteresis	10% - 30% of set-point
Campo di temperatura	-30°C...+140°C (in funzione della membrana/guarnizione)	Temperature range	-30°C to +140°C (according to diaphragm/gasket material)
Num. max. interventi a 25°C	120/1' (membrana)	Max. cycle rate at 25°C	120/min. (diaphragm type)
Num. max. interventi a 25°C	60/1' (pistone)	Max. cycle rate at 25°C	60/min. (piston type)
Protezione	IP 65 DIN 40050 vedi pagina 46	Protection	IP 65 DIN 40050 see page 46
Connettore PG09 o PG11	DIN 43650	PG09 or PG11 connector	DIN 43650
Vita meccanica	10 ⁶ cicli	Mechanical life	10 ⁶ operations
Coppia di serraggio consigliata	max. 5 Kgm.	Recommended tightening torque	max. 5 Kgm.

CONNESSIONI ELETTRICHE DISPONIBILI / AVAILABLE ELECTRICAL CONNECTIONS

PROTEZIONE IP 65 IP 65 PROTECTION

PROTEZIONE IP 54 IP 54 PROTECTION

Connettore Din 40050
Din 40050 Connector

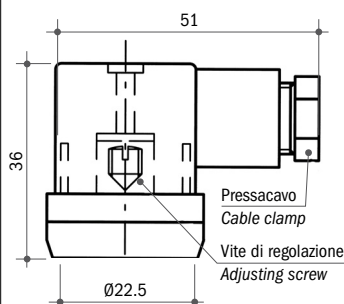

Connettore trasparente con Led bicolore rosso/verde
Transparent connector with red/green bi-coloured led
Tipo
Type **CLB**

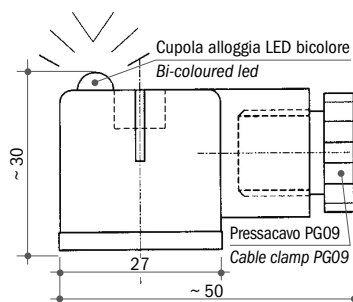

Connettore M12
M12 Connector

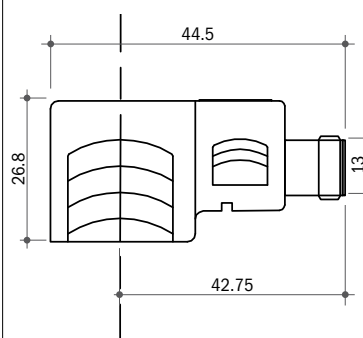

COD. 30013
Tipo / Type **CAP 12**

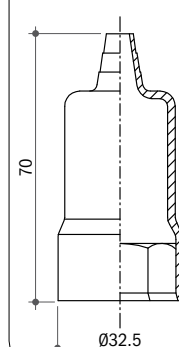

SIGLA DI ORDINAZIONE / HOW TO ORDER

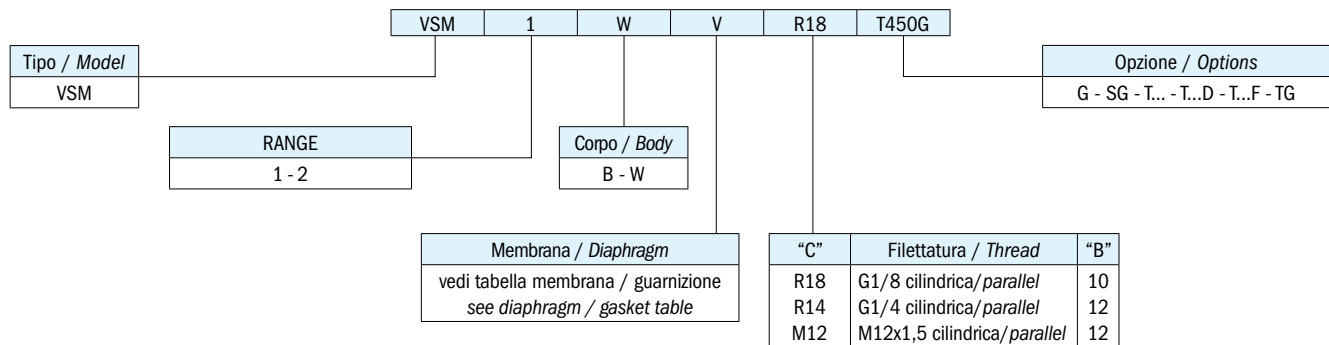

SPIEGAZIONE DELLE SIGLE DI ORDINAZIONE / ORDERING INFORMATION

VSM...	Vuotostato con contatti SPDT a membrana	
Materiale corpo	B	Ottone
	W	Acciaio Inox AISI 316
Membrana disponibile/ Guarnizione	-	NBR (standard) -5°C...+90°C
	NT	HNBR -25°C...+140°C
	V	FKM -5°C...+90°C
	S	Silicone -30°C...+120°C
	C	Neoprene -10°C...+90°C
	E	EPDM -20°C...+110°C
Attacchi filettati "A"	R18	G1/8 cilindrico
	R14	G1/4 cilindrico
	M12	M12 x 1.5 cilindrico
Opzioni	G	Contatti dorati per bassa corrente
	SG	Sgrassati per ossigeno
	T...	Taratura in salita (es. T250mbar taratura a -250 mbar)
	T...D	Taratura in discesa (es. T350D taratura in discesa a -350 mbar)
	T...F...	Taratura del vuotostato e del differenziale se >10% max. 30% valore effettivo (es. T400 F100 taratura in salita a -400mbar con differenziale di 100 mbar)

IN CONFORMITÀ ALLE NORME 2004/108 CE RELAZIONE EMC N° 147E/96.

VSM...	Diaphragm vacuum switch with SPDT contacts	
Body material	B	Brass
	W	S.S. 316
Available diaphragm/ Gasket	-	NBR (standard) -5°C to +90°C
	NT	HNBR -25°C to +140°C
	V	FKM -5°C to +90°C
	S	Silicone -30°C to +120°C
	C	Neoprene -10°C to +90°C
	E	EPDM -20°C to +110°C
Threads	R18	G1/8 parallel
	R14	G1/4 parallel
	M12	M12 x 1.5 parallel
Options	G	Gold-plated contacts for low current
	SG	Degreased for applications with oxygen
	T...	Set-point adjustment rising at the required value (ex. T250 set rising at -250 mbar)
	T...D	Set-point adjustment falling at the required value (ex. T350D set rising falling at -350 mbar)
	T...F...	Set-point and hysteresis at the required value if > 10% max 30% of set-point (ex. T400F100 set point at -400 mbar with hysteresis at 100 mbar)

IN COMPLIANCE WITH 2004/108 CE RULES EMC N° 147E/96 REPORT.

CARATTERISTICHE GENERALI / GENERAL SPECIFICATIONS

TIPO MODEL	CAMPO DI LAVORO PRESSIONI RELATIVE ADJUSTMENT RELATIVE PRESSURE RANGE mbar	DIMENSIONI "A" DIMENSIONS "A" mm	MAX. PRESSIONE STATICA SUPPORTABILE MAX. STATIC PRESSURE bar		TOLLERANZA D'INTERVENTO 25°C TOLERANCE AT 25°C mbar	ESECUZIONE EXECUTION
			OTTONE BRASS	ACCIAIO INOX 316 S.S. 316		
VSM 1	-100 / -500	73	20		±50	NBR Membrane Diaphragm
VSM 2	-500 / -900		20		±80	
VSM 1 W	-100 / -500			20	±50	
VSM 2 W	-500 / -900			20	±80	

Elettrotec si riserva la facoltà di apportare modifiche tecniche ai prodotti o di cessarne la produzione senza obbligo di preavviso. Il contatto del pressostato può danneggiarsi quando sottoposto a forti urti o ad alte vibrazioni. È responsabilità dell'utilizzatore verificare l'idoneità dei nostri prodotti per ogni particolare applicazione (ad esempio, la verifica della compatibilità dei materiali) e l'uso può essere appropriato solo se dimostrato in test sul campo. Le informazioni tecniche in questo catalogo si basano su prove effettuate durante lo sviluppo del prodotto e in base ai valori empiricamente raccolti. Essi non possono essere applicabili in tutti i casi.

Elettrotec reserves the right to technical data of change to the products or halt production without prior notice. The pressure switch contacts can be damaged when subject to strong shocks or high vibration. It is the responsibility of the user to test the suitability of our products for the particular application, for example, the verification of material compatibility. The use may only be appropriate if proven in field tests. The technical information in this catalogue are based on tests made during product development and based on empirically gathered values. They may not be applicable in all cases.









VUOTOSTATI / VACUUM SWITCHES

MATRICE PRODOTTI / SELECTION MATRIX

		VCN	VCM	VS	VSM	VMC
Pagina / Page		31	33	35	37	39
	Vuotostato / Vacuum switch	●	●	●	●	●
	Contatto NA / NO Contact	●	●			
	Contatto NC / NC Contact	●	●			
	Contatto SPDT / SPDT Contact			●	●	●
	Esecuzione a membrana / Membrane execution	●	●	●	●	●
	Regolabile / Adjustable	●	●	●	●	●
	Isteresi fissa / Fixed hysteresis	●	●	●		●
	Isteresi regolabile / Adjustable hysteresis				●	
Dati elettrici / Electrical data	Massimo 48V / Max. 48V	●	●			
	Massimo 250V / Max. 250V			●	●	●
	10 mA	●	●	●	●	
	0,5 Ampere	●	●			
	3 Ampere					●
	6 Ampere			●	●	
	Contatti argentati / Silver plated contacts	●	●	●	●	●
	Contatti dorati / Gold plated contacts	●	●	●	●	
Campo di lavoro / Working range	-200 / -900 mbar	●	●			
	-100 / -500 mbar			●	●	●
	-500 / -900 mbar			●	●	●
Pressione statica max. / Max. Static Pressure	20 bar	●	●	●	●	●
Materiale corpo / Body material	Ottone / Brass	●	●	●	●	
	Acciaio zincato / Zinc plated steel					●
	Inox AISI 316 / Stainless steel 316	●	●	●	●	
Connessione elettrica / Electric connection	Fast-on / Push-on terminals	●		●		
	Morsetto a vite / Screw terminals		●			
	Connettore DIN 43650 / DIN connector 43650				●	●
Protezione elettrica / Electric protection	IP 54	●	●	●	●	
	IP 65		●	●	●	●
	IP 67	●		●		
Omologazioni / Certification	ATEX / ATEX				●	●
	R.I.N.A. / R.I.N.A.				●	●
	LLOYD'S / LLOYD'S				●	●
	IMQ / IMQ				●	

VUOTOSTATI / VACUUM SWITCHES

PROTEZIONI ELETTRICHE / ELECTRIC PROTECTIONS

		VCN	VCM	VS	VSM	VMC
Pagina / Page		31	33	35	37	39
Protezione IP 54 / IP 54 electric protection	CAP 1 	●	●			
	CAP 10 	●	●			
	CAP 12 				●	
	CAP 16 			●		
Protezione IP 65 / IP 65 electric protection	CAP 3 		●			
	CAP 13 			●		
	Connettore Din 40050 / Din 40050 Connector 				●	●
Protezione IP 67 / IP 67 electric protection	Cap 14 + Cavi + Connettore Cap 14 + Flying Leads + Connector 			●		
	Connettore M12 / M12 Connector 			●		

DATI TECNICI / TECHNICAL DATA

		VCN	VCM	VS	VSM	VMC
Tensione di alimentazione / Power supply	12 Vca/cc	●	●	●	●	●
	24 Vca/cc	●	●	●	●	●
	48 Vca/cc	●	●	●	●	●
	110 Vca/cc			●	●	●
	220 Vca/cc			●	●	●
	250 Vca/cc			●	●	●
Corrente massima / Max. current	< 30 mA	●	●	●	●	●
	0,5 A	●	●			
	3 A					●
	6 A			●	●	
Contatti argentati / Silver plated contacts		●	●	●	●	●
Contatti dorati / Gold plated contacts		●	●	●	●	●
Isteresi fissa / Fixed Hysteresis		●	●	●		●
Isteresi regolabile / Adjustable Hysteresis					●	
Corpo CH. 24 / Body 24 AF		●	●	●		
Corpo CH. 27 / Body 27 AF					●	

Elettrotec si riserva la facoltà di apportare modifiche tecniche ai prodotti o di cessarne la produzione senza obbligo di preavviso. Il contatto del pressostato può danneggiarsi quando sottoposto a forti urti o ad alte vibrazioni. È responsabilità dell'utilizzatore verificare l'idoneità dei nostri prodotti per ogni particolare applicazione (ad esempio, la verifica della compatibilità dei materiali) e l'uso può essere appropriato solo se dimostrato in test sul campo. Le informazioni tecniche in questo catalogo si basano su prove effettuate durante lo sviluppo del prodotto e in base ai valori empiricamente raccolti. Essi non possono essere applicabili in tutti i casi.

Elettrotec reserves the right to technical data of change to the products or halt production without prior notice. The pressure switch contacts can be damaged when subject to strong shocks or high vibration. It is the responsibility of the user to test the suitability of our products for the particular application, for example, the verification of material compatibility. The use may only be appropriate if proven in field tests. The technical information in this catalogue are based on tests made during product development and based on empirically gathered values. They may not be applicable in all cases.