

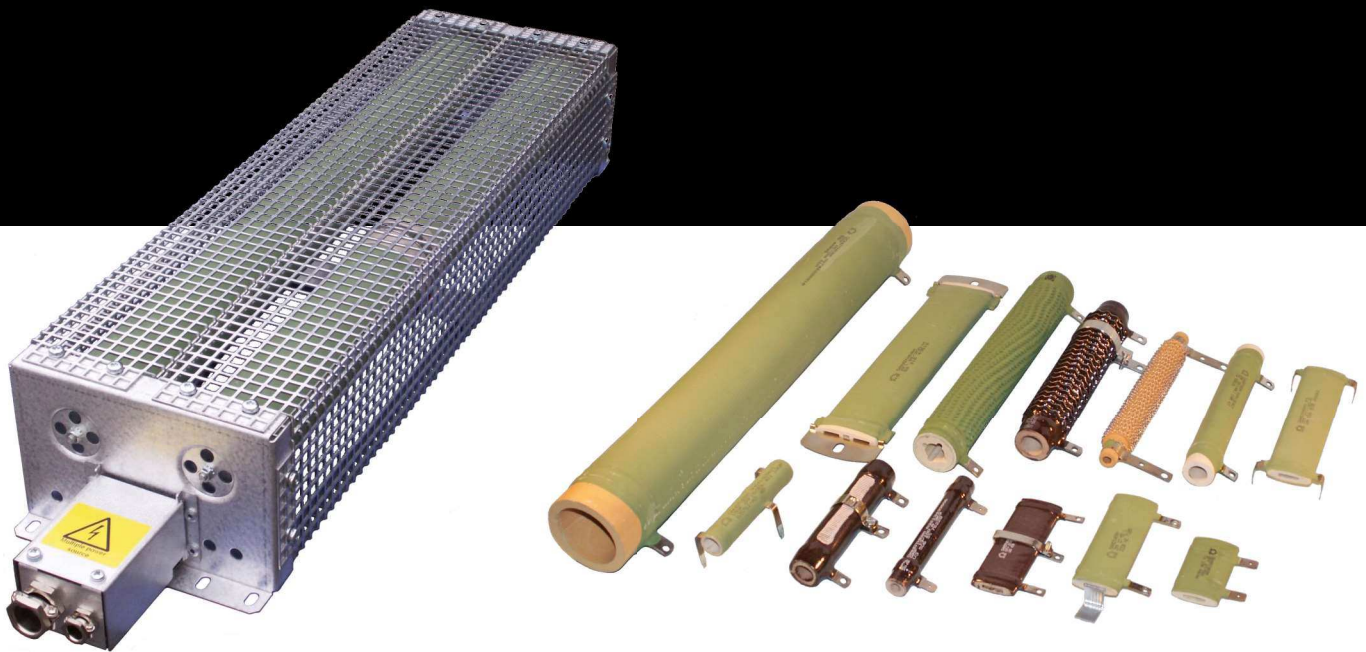

DANOTHERM™



Wirewound resistors

Vitreous Enamelled and Cement Coated
Round and Oval Shaped
Sigma Modular Wirewound Brake Resistors

- 15–5000W
- Solder, Screw or Fast-on terminals
- Different styles of mounting brackets
- Open type IP00 and Sigma IP20
- Increased creepage distance for high voltage applications
- Optional Live terminals (only oval shaped types)
- Wide ohm range

Round Wirewound Resistors

DANOTHERM TYPE	P nom * @25°C T=350°C	CRITICAL VOLT rms	INSU- LATION VOLT **	CRIT. RES	RMIN ± 15%	± 10% GRV ZRV	ZBF	RMAX	GRF ZRF	GRV ZRV	GRI ZRI	ZBF	PREF
	W	V	V	kΩ	ZRF/I mΩ	Ω	mΩ	kΩ	kΩ	kΩ	Ω	Ω	
GRF/ZRF 10/44	17	270	1000	4,2	56	0,8	-	8	1,8	22	-	-	P
GRF/ZRF 10/55	22	430	1000	8,4	100	0,6	-	12	2,7	33	-	-	
GRF/ZRF 10/63	25	550	1000	12	100	0,6	-	18	3,9	47	-	-	P
GRF/ZRF 12/51	24	370	1000	5,7	47	1	-	12	3,3	39	-	-	
GRF/ZRF 12/63	30	550	1000	10	56	1	-	22	4,7	56	-	-	P
GRF/ZRF 12/76	36	750	1000	15	82	1	-	27	5,6	68	-	-	
GRF/ZRF 12/102	48	1200	1000	30	82	1	-	47	8,2	120	-	-	P
GRF/ZRF 13/51	28	370	1200	4,8	56	1	-	18	3,6	47	-	-	P
GRF/ZRF 13/63	32	550	1200	9,4	56	1	-	22	5,6	47	-	-	P
GRF/ZRF 13/100	52	1100	1200	23	82	1	-	47	10	120	-	-	P
GRF/ZRF 15/51	30	370	1200	4,5	56	1	68	18	3,3	47	3	-	
GRF/ZRF 15/63	38	550	1200	7,9	56	1	100	27	5,6	56	6	-	P
GRF/ZRF 15/76	45	750	1200	12	82	1	150	33	6,8	68	8	-	
GRF/ZRF 15/100	60	1100	1200	20	82	1	220	58	12	120	12	-	P
GRF/ZRF 20/50	40	360	1200	3,2	56	0,3	33	22	4,7	47	4	-	
GRF/ZRF 20/75	60	730	1200	8,8	100	0,3	75	47	10	100	8	-	
GRF/ZRF 20/100	78	1100	1200	15	220	0,3	120	56	15	150	12	-	P
GRF/ZRF 20/140	100	1700	1200	28	220	0,3	180	82	22	220	22	-	P
GRF/ZRF 20/165	120	2100	1200	36	220	0,5	220	100	27	280	27	-	P
GRF/ZRF 20/267	200	3600	1200	64	220	1	390	150	47	470	47	-	P
GRF/ZRF 24/165	150	2100	1200	29	220	1	180	100	33	270	27	-	P
GRF/ZRF 30/75	85	730	1200	6,2	120	1	39	39	15	120	12	-	
GRF/ZRF 30/100	110	1100	1200	11	180	1	68	56	22	180	18	-	P
GRF/ZRF 30/133	150	1600	1200	17	270	1	100	78	33	220	27	-	P
GRF/ZRF 30/152	170	1900	1200	21	330	1	120	82	39	270	33	-	P
GRF/ZRF 30/156	175	2000	1200	22	330	1	120	82	42	270	33	-	P
GRF/ZRF 30/165	185	2100	1200	23	330	1	150	100	42	330	39	-	
GRF/ZRF 30/200	225	2600	1200	30	390	1	150	120	47	420	42	-	P
GRF/ZRF 30/215	245	2900	1200	34	470	1	180	150	56	470	47	-	
GRF/ZRF 30/250	275	3400	1200	42	560	1	220	150	68	560	56	-	
GRF/ZRF 30/265	300	3600	1200	43	560	1	220	180	68	560	68	-	P
GRF/ZRF 30/330	375	4600	3000	56	680	1	270	180	82	750	75	-	P
ZRF 45/370	600	5200	2400	45	1	1	200	-	1000	120	-	-	
ZRF 55/100	180	800	3000	3,5	150	1	120	47	-	180	18	-	P
ZRF 55/150	250	1200	3000	5,7	300	1	270	56	-	270	39	-	P
ZRF 55/215	330	1900	3000	10	560	1	560	75	-	330	47	-	P
ZRF 55/290	450	2700	3000	16	820	1	680	100	-	470	68	-	P
ZRF 55/300	450	2800	3000	17	1000	1	820	100	-	470	68	-	
ZRF 55/390	600	3700	3000	22	1200	1,2	1000	150	-	620	100	-	P
ZRF 55/400	600	3800	3000	24	1200	1,5	1000	150	-	620	100	-	
ZRF 55/490	800	4700	3000	27	1500	1,5	1200	180	-	750	120	-	P
ZRF 55/500	800	4800	3000	28	1500	2,2	1200	180	-	750	120	-	
ZRF 55/590	1000	5700	3000	32	1500	2,2	1500	200	-	1000	150	-	P

* Nominal power rating; for corrugated wire types (ZBF/GBF) allow 20% higher power.
High ohm values, exceeding critical resistance values, should be de-rated by 25%.
Induction low types should be de-rated by 50%.

** standard insulation voltage levels, higher levels on request.

Item description

ZBF 30/330 S xxR K 000

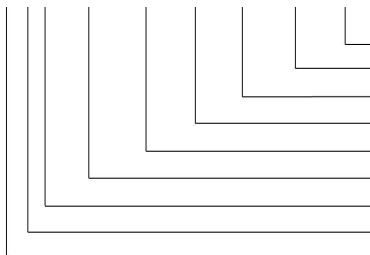

Drawing No. (001 = 5% tolerance; 000 = 10% tolerance.),
other numbers are customized types
Resistance tolerance J = 5%, K = 10%
Ohmic value (16R = 16; 5k6 = 5.6k)
S: Screw (order separate in bag) / L: Tinned / A: Fast-On
Length of resistor body in mm
Diameter of resistor body in mm
F: Fixed resistor / I: Low induction / V: Adjustable
R: Normal wire / B: Corrugated flat wire
G: Vitreous Enamelled / Z: Cement coated

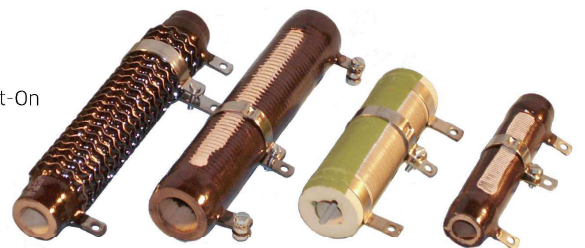

Vitreous Enamelled and Cemented Power Resistors from 15W to 1000W

Danotherm Electric A/S was founded in Copenhagen in 1919. We manufacture high performance reliable electrical components and systems. Our products can be found in the most professional sectors of the industry.

Our standard program includes:

GRF/ZRF: fixed resistors for ac and dc current. Standard tolerance of ± 10% and 5% on request. Can be fitted with mounting feet and intermediate bands if required.

GRV/ZRV: resistor with one or more variable connection band.

GRI/ZRI: induction low resistors by double winding (Ayrton-Perry)

GBF/ZBF: corrugated winding for high pulse load and low ohm values. The corrugated wire functions as fins, increasing the active surface area. As a rule of thumb, the nominal power increases by some 20%. Also available in variable band types (GBV/ZBV)

Specifications:

All-welded construction.

Tolerance:

R > 1 : ±5% or 10 % (see table 1)

Power rating: Based on 25°C and Horizontal mounting.

Temperature Range: -50°C - 250°C

Temperature coefficient:

Low ohm: 200 (400ppm)/°.

Medium-high ohm: <100ppm/°.

Dielectric voltage: Based on indicated creepage distance (k in table 2) from terminals to mounting bracket. 5mm: 1000V; 6mm: 1200V.

Other values than indicated are possible.

Overload:

General: 10 X in 5 seconds.

Materials:

Core:

Diameter 10-30 mm: Steatite C221
 Porcelain C110, only certain types.
 Diameter 45mm: Porcelain C410
 Diameter: 55mm: Corderite C520
 Steatite C221 is the optimal choice of ceramic bases material for temperatures below 350 -400°C. It has high mechanical strength and excellent DC stability. If higher temperatures can be expected porcelain C110 can be used. For our large resistor types, corderite C520 are used due to its very high stability to temperature changes.

Terminals:

FeNi42 ; has an equivalent temperature expansion coefficient likes Steatite. FeNi42. Can be soldered when it is clean from oxidation and is relatively stainless.

Wire:

Low Ohms: CuNi10 (T.C: 400ppm)/
 CuNi23Mn (T.C: 200ppm)
 Medium Ohms:
 CuNi44 (T.C. < 80ppm)
 High Ohms: NiCr8020; CrAlFe,
 (T.C. <100ppm)

Coating:

Vitreous Enamel, excellent protection to thin wires. All Vitreous Enamelled Resistors meet the IEC 68-2-3 Ca. 56 days. Vitreous enamel can only be used on Steatite.
 AlPO4 is the best choice regarding high pulse load capability and high temperature stability.

Thermal models are available

Each resistor can be provided with data sheets including an individual thermal model for simulating temperature rises during load. Please, see last page.

TYPE	Profile	D	L	L Tol.	d	D max	b L, S/A	e	c	k min	L1 ± 1 L, S/A	LB	f x i	Typ. Mass
		mm Ø	mm	+mm	mmØ	mm	mm	mmØ	mm	mm	mm	mm	mm	g
GRF/ZRF 10/44	1		44	0,7			4,8/6,3	3,2		5	32,3/30,8	58		11
GRF/ZRF 10/55	1	10	55	0,9	6	13	4,8/6,3	3,2	19	5	43,1/41,6	69	3,2X6	14
GRF/ZRF 10/63	1		63	1,2			4,8/6,3	3,2		5	50,9/49,4	77		15
GRF/ZRF 12/51	1		51	0,9			4,8/6,3	3,2		5	39,2/37,7	65		19
GRF/ZRF 12/63	1	12	63	1,2	5,5	16	4,8/6,3	3,2	16,5/21	5	50,9/49,4	77	3,2X6	22
GRF/ZRF 12/76	1		76	1,4			4,8/6,3	3,2		5	63,7/62,2	90		26
GRF/ZRF 12/102	1		102	2,0			4,8/6,3	3,2		5	89,2/87,7	116		34
GRF/ZRF 13/51	1		51	0,9	8,3		4,8/6,3	3,2		6	38,2/36,7	-		20
GRF/ZRF 13/63	1	13	63	1,2	5,5	17	4,8/6,3	3,2	15,5 / 20	6	49,4/48,4	-	-	24
GRF/ZRF 13/100	1		100	1,8	5,5		4,8/6,3	3,2		6	86,2/84,7	-		40
GRF/ZRF 15/51	1		51	0,9			4,8/8	3,2		6	38,2/35	65		22
GRF/ZRF 15/63	1		63	1,2			4,8/8	3,2		6	49,4/46,7	77		26
GRF/ZRF 15/76	1	15	76	1,4	10	19	4,8/8	3,2	22	6	62,7/59,5	90	4,2X8	30
GRF/ZRF 15/100	1		100	1,8			4,8/8	3,2		6	86,2/83	114		40
GRF/ZRF 20/50	1		50	0,8			4,8/8	3,2		6	37,2/34	66		40
GRF/ZRF 20/75	1		75	1,4			4,8/8	3,2		6	61,7/58,5	91		55
GRF/ZRF 20/100	1	20	100	1,8	12	24	8	4,2	22/25	6	83	116	5,5X8	70
GRF/ZRF 20/140	1		140	2,5			8			6	122,2	156		100
GRF/ZRF 20/165	1		165	3,0			8			6	146,7	181		115
GRF/ZRF 20/267	1		267	4,6			8			6	246,7	283		190
GRF/ZRF 24/165	1		165	3,0			8			6	146,7	181		155
GRF/ZRF 30/75	1		75	1,4			8			6	58,5	93		105
GRF/ZRF 30/100	1;3		100	1,8			8			6	83	118		135
GRF/ZRF 30/133	1;3		133	2,5			8			6	115,3	151		175
GRF/ZRF 30/152	1		152	2,8			8			6	134	170		200
GRF/ZRF 30/156	1	30	156	3,0	20	34	8	4,2	30	6	137,9	174	5,5X8	207
GRF/ZRF 30/165	1;3		165	3,0			8			6	146,7	183		220
GRF/ZRF 30/200	1		200	3,8			8			6	181	218		265
GRF/ZRF 30/215	1;3		215	4,2			8			6	195,7	233		285
GRF/ZRF 30/250	1;3		250	4,2			8			6	230	268		320
GRF/ZRF 30/265	1;3		265	4,6			8			6	244,7	283		350
GRF/ZRF 30/330	1;3		330	5			8			15	301	348	5,5X8	440
ZRF 45/370	1	45	370	5,5	30	50	10	5,2	39	12	341,6	-	-	950
ZRF 55/100	1		100	1,8			10			15	72	124		260
ZRF 55/150	1		150	2,5			10			15	111,2	175		355
ZRF 55/210	1		210	4,2			10			15	179,8	236		525
ZRF 55/290	1		290	4,6			10			15	258,2	317		725
ZRF 55/300	1	55	300	4,6	42	60	10	5,2	43,5	15	268	327	5,5X10	740
ZRF 55/390	1		390	5,5			10			15	356,2	418		940
ZRF 55/400	1		400	5,5			10			15	366	428		960
ZRF 55/490	1		490	6,8			10			15	454,2	517		1200
ZRF 55/500	1		500	6,8			10			15	464	527		1230
ZRF 55/590	1		590	7,6			10			15	553	618		1450

Table 2, Mechanical Specifications

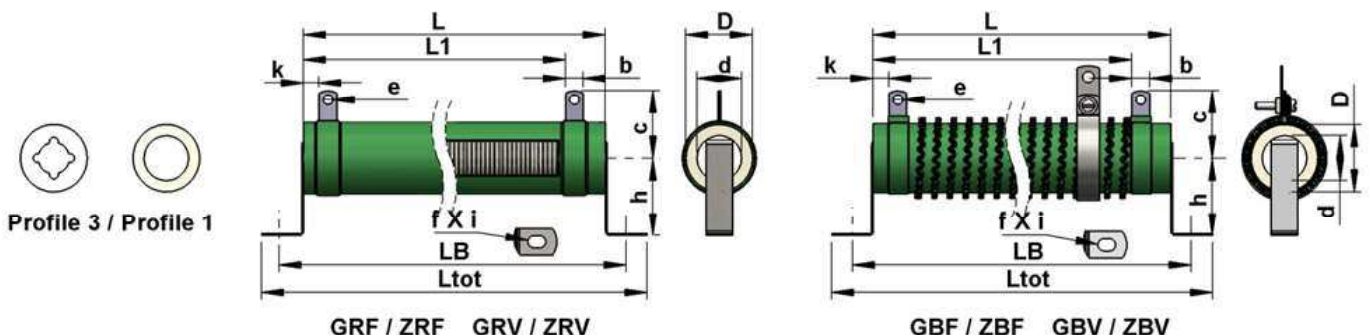

Flat Oval Shaped Wirewound Resistors

DANOTHERM	P nom * T=350°C @ 25°C	CRITICAL VOLT	INSULA- TION VOLT **	RES	RMIN		RMAX		
TYPE	W	V	V	kΩ	mΩ	Ω	kΩ	kΩ	Ω
GFF/ZFF 20/50	30	360	1000	4.3	56	1	5.6	-	47
GFF/ZFF 20/80	50	810	1000	13	75	1	12	-	82
GFF/ZFF 20/90	55	960	1000	16	100	1	12	-	100
GFF/ZFF 20/100	60	1100	1000	20	120	1	15	-	120
GFF/ZFF 20/120	70	1400	1000	28	150	1	18	-	150
GFF/ZFF 27/50(-M)	40	360	1200	3.2	56	1	6.8	3.3	47
GFF/ZFF 27/80(-M)	60	810	1200	10	68	1	15	6.8	100
GFF/ZFF 27/90(-M)	65	960	1200	14	82	1	18	8.2	120
GFF/ZFF 27/100(-M)	70	1100	1200	17	100	1	22	10	150
GFF/ZFF 27/120(-M)	90	1400	1200	21	120	1	27	12	220
GFF/ZFF 27/153(-M)	110	1900	1200	32	150	1	33	15	270
ZFF 45/150(-M)	180	1900	1200	20	150	1	47	-	270
ZFF 45/200(-M)	225	2600	1200	30	180	1	68	-	330
ZFF 45/250(-M)	280	3400	1200	41	220	1	100	-	470
ZFF 78/100(-M)	180	800	3000	3.5	150	1	4.7	-	180
ZFF 78/140(-M)	250	1200	3000	5.7	300	1	5.6	-	270
ZFF 78/210(-M)	330	1900	3000	10	560	1	7.5	-	330
ZFF 78/290(-M)	450	2700	3000	16	820	1	10	-	470
ZFF 78/390(-M)	600	3700	3000	22	1200	1.2	15	-	620
ZFF 78/490(-M)	800	4700	3000	27	1500	1.5	18	-	750

TYPE	D max	d max	L	L Tol.	L1 ± 1 L1. S/A	Lb	Ltot	kmin	b L1. S/A	e	f x i	Typ. Mass
	mm	mm	mm	± mm	mm	mm	mm	mm	mm ø	mm	mm	g
GFF/ZFF 20/50	23	9.5	50	1	38.2/36.7	67	86	5	4.8/6.3	3.2	5.5x10.5	22
GFF/ZFF 20/80	23	9.5	80	1.6	67.6/66.1	97	116	5	4.8/6.3	3.2	5.5x10.5	32
GFF/ZFF 20/90	23	9.5	90	1.8	77.4/75.9	107	126	5	4.8/6.3	3.2	5.5x10.5	35
GFF/ZFF 20/100	23	9.5	100	2	87.2/85.7	117	136	5	4.8/6.3	3.2	5.5x10.5	40
GFF/ZFF 20/120	23	9.5	120	2.4	106.8/105.3	137	156	5	4.86.3	3.2	5.5x10.5	45
GFF/ZFF 27/50	30	10	50	1	37.2/35.7	67	86	6	4.8/6.3	3.2	5.5x10.5	30
GFF/ZFF 27/80	30	10	80	1.6	66.6/65.1	97	116	6	4.8/6.3	3.2	5.5x10.5	45
GFF/ZFF 27/90	30	10	90	1.8	76.4/74.9	107	126	6	4.8/6.3	3.2	5.5x10.5	48
GFF/ZFF 27/100	30	10	100	2	86.2/84.7	117	136	6	4.8/6.3	3.2	5.5x10.5	55
GFF/ZFF 27/120	30	10	120	2.4	105.8/104.3	137	156	6	4.8/6.3	3.2	5.5x10.5	65
GFF/ZFF 27/153	30	10	153	3.1	138.1/136.6	170	189	6	4.8/6.3	3.2	5.5x10.5	75
ZFF 45/150	48	12	150	3	136	170	190	6	8	4.2	6.5x10	155
ZFF 45/200	48	12	200	4	185	220	240	6	8	4.2	6.5x10	200
ZFF 45/250	48	12	250	5	234	270	290	6	8	4.2	6.5x10	250
ZFF 78/100	81	25	100	2	72	137	164	15	10	5.3	6.5x12	260
ZFF 78/140	81	25	140	2.8	111	177	204	15	10	5.3	6.5x12	355
ZFF 78/210	81	25	210	4.2	178	247	274	15	10	5.3	6.5x12	525
ZFF 78/290	81	25	290	5.8	258	327	354	15	10	5.3	6.5x12	725
ZFF 78/390	81	25	390	7.8	356	427	454	15	10	5.3	6.5x12	940
ZFF 78/490	81	25	490	9.8	454	527	554	15	10	5.3	6.5x12	1200

* Nominal power rating;
High ohm values, exceeding critical resistance values, should be de-rated by 25%.
Induction low types should be de-rated by 50%.
** standard insulation voltage levels, higher levels on request.

Item description

ZFF 45/200 S xxR K 000

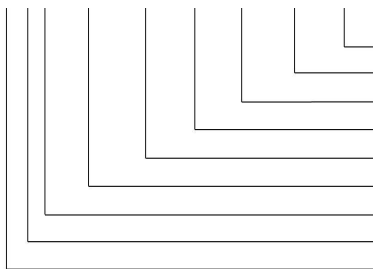

Drawing No. (000 is standard)
Resistance tolerance 5%, 10% or 15%
Ohmic value (16R = 16; 5k6 = 5.6k)
S: Screw / L: Tinned / A: Fast-On
Length of resistor body in mm
Diameter of resistor body in mm
F: Flat resistor / I: Low induction / V: Adjustable
F: Flat / Oval type
G: Vitreous Enamelled / Z: Cement coated

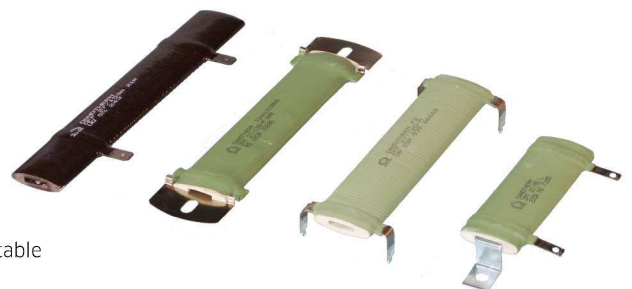

Custom designed resistors and assemblies are available on request. Details like wire configuration, creepage distance and inductance can be specified by the customers. The choice between more than 50 sizes guarantee our customer that the best resistor configuration can be found within our program. Special lengths are very well possible.

Contact our sales department or email: danotherm@danotherm.dk for special configurations.

Standard, 'Turtles' and 'M-types':

Flat Oval Shaped Vitreous Enamelled or Cement Coated Resistors can be supplied in various types: A 'Turtle' style, having 4 soldering legs to stand on, ideally suited for mounting on PCB's with good mechanical stability. 'Turtles' are offered in 78mm types. (all lengths)

Mechanical Dimensions:

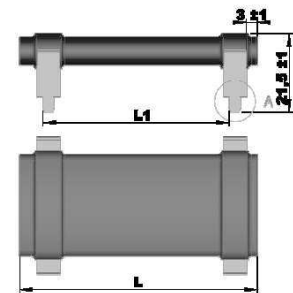

M-type Oval shaped wirewound resistors have live terminals for easy electrical and mechanical connection.

Overload Capability

Wirewound resistors can be overloaded during certain time for several their nominal power rating. Underneath curve shows the overload capability in percentage of the nominal power for pulse loads at given duration with a cycle time of 120 seconds.

Temperature rise at constant load.

The maximum surface temperature rise is 350°C. Underneath curve shows the relation between power and surface temperature. For very dynamic power loads we suggest our Cement Coated resistors.

At elevated ambient temperatures

the admissible maximum power dissipation must be de-rated to prevent over-heating. De-rating is done linearly from 25°C to 350°C at 100% nominal power to 0. Underneath curve shows the relation between ambient temperature and max power dissipation.

Forced air cooling increases the ability to expel heat to the ambient air. Underneath curve show the relation between airspeed and maximum admissible power dissipation.

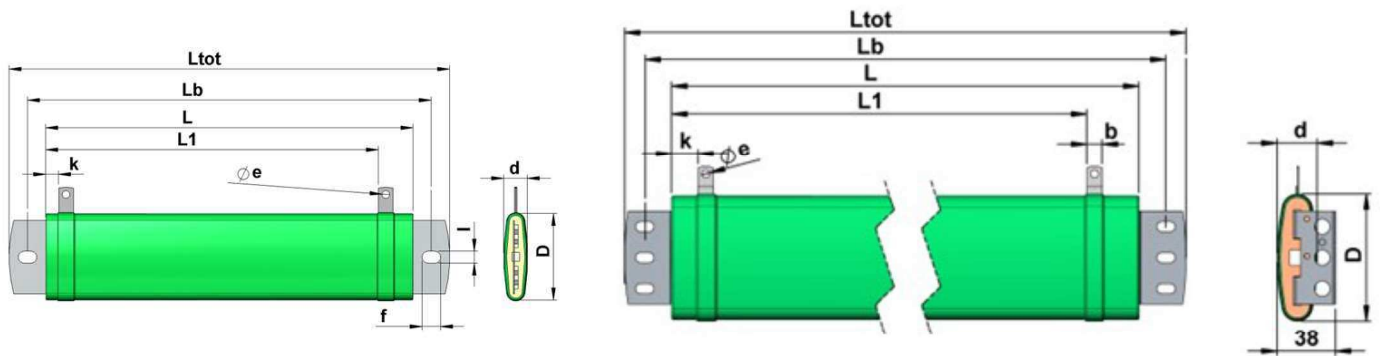
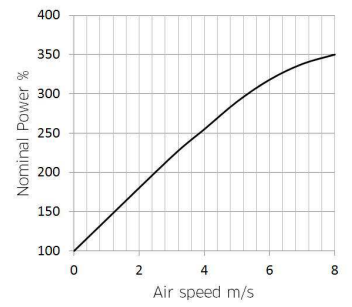
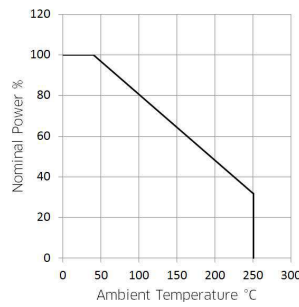
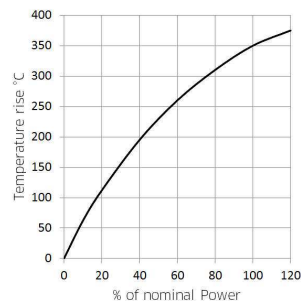
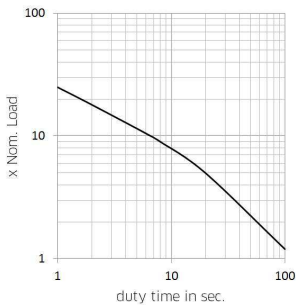

M-type Live-Terminals Wirewound Resistors

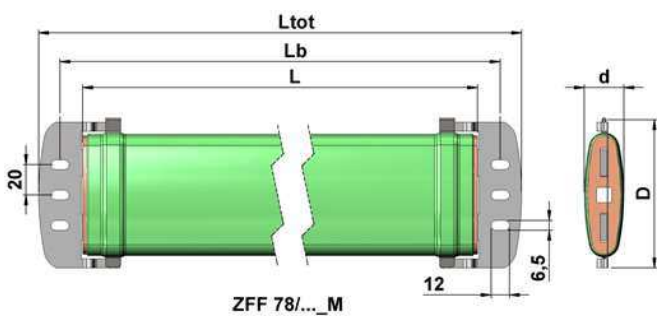

TYPE	D max mm	d max mm	L mm	L Tol. ± mm	Lb mm	Ltot mm	f x i mm	Typ. Mass g
GFF/ZFF 27/50-M	37	10	50	1	67	86	5.5x10	30
GFF/ZFF 27/80-M	37	10	80	1.6	97	116	5.5x10	45
GFF/ZFF 27/90-M	37	10	90	1.8	107	126	5.5x10	48
GFF/ZFF 27/100-M	37	10	100	2	117	136	5.5x10	55
GFF/ZFF 27/120-M	37	10	120	2.4	137	156	5.5x10	65
GFF/ZFF 27/153-M	37	10	153	3.1	169	188	5.5x10	75
ZFF 45/150-M	59	12	150	3	170	190	6.5x10	155
ZFF 45/200-M	59	12	200	4	220	240	6.5x10	200
ZFF 45/250-M	59	12	250	5	270	290	6.5x10	250
ZFF 78/100-M	96	25	100	1.8	128	156	6.5x12	260
ZFF 78/140-M	96	25	140	2.5	168	196	6.5x12	355
ZFF 78/210-M	96	25	210	4.2	238	266	6.5x12	525
ZFF 78/290-M	96	25	290	5	318	346	6.5x12	725
ZFF 78/390-M	96	25	390	5.5	418	446	6.5x12	940
ZFF 78/490-M	96	25	490	6.8	518	546	6.5x12	1200

Σ SIGMA–Modular Wirewound Brake Resistors

SIGMA is our range of **MODULAR BRAKE RESISTORS**. Thanks to the modular construction it is possible also at small quantities to supply an optimum solution to any problem concerning starter brake resistors in connection with frequency converters. The resistor components consist of fully welded wire wound ceramic resistors, which is a well-known and approved technology. The base material is corderite, which is a type of ceramic with a very high resistance to temperature changes and the wire is coated with aluminium phosphate to protect the wire and conduct the heat developed in the wire on to the ceramic core. Aluminium-phosphate is stable at 700°C.

The modular resistor cages comply with IP20 and give electrical and thermal Protection The resistors have a nominal load from 100W and upward and are particularly suitable for pulse load of 10 – 20 time or more compared to the nominal load because of the ceramic core material and an extra high weight of wire. We have developed **thermal models** corresponding to all resistor types and resistor values. By using these models we are able to calculate the temperature rises in the resistor wire for all possible load situations. Danotherm offers our assistance to our customers to find the optimum solution for any situation.

Type	Weight	Ohmic Range	Number of Resistors	Nominal Load	Pulse Load 10% E.D. 10sec	Width	Length	Height	Mount. Holes	Mount. Holes
	kg	mΩ - kΩ		W	kW	mm	mm	mm	mm	mm
ZRF 55 / 100 OX1	1.1	120 - 47	1	180	1,25	89	160	115	64	135
ZRF 55 / 150 OX1	1.2	270 - 56	1	250	1,70	89	210	115	64	186
ZRF 55 / 150 OX2	2		2	500	3,40	176	210	115	150	186
ZRF 55 / 150 OX3	3.2		3	750	5,00	265	210	115	240	186
ZRF 55 / 150 OX4	3.8		4	800	5,80	176	210	230	150	186
ZRF 55 / 150 OX6	5.7		6	1200	8,70	265	210	230	240	186
ZRF 55 / 220 OX1	2.1	560 - 75	1	330	2,6	89	270	115	64	246
ZRF 55 / 220 OX2	2.9		2	650	5,20	176	270	115	150	246
ZRF 55 / 220 OX3	4.1		3	1000	7,80	265	270	115	240	246
ZRF 55 / 220 OX4	5		4	1100	8,60	176	270	230	150	246
ZRF 55 / 220 OX6	7.2		6	1500	12,50	265	270	230	240	246
ZRF 55 / 300 OX1	2.2	680 - 100	1	450	3,60	89	350	115	64	326
ZRF 55 / 300 OX2	3.5		2	900	7,20	176	350	115	150	326
ZRF 55 / 300 OX3	5.1		3	1300	10,80	265	350	115	240	326
ZRF 55 / 300 OX4	6.3		4	1500	12,00	176	350	230	150	326
ZRF 55 / 300 OX6	9		6	2200	18,00	265	350	230	240	326
ZRF 55 / 400 OX1	2.4	1000 - 150	1	600	4,80	89	450	115	64	426
ZRF 55 / 400 OX2	4.2		2	1200	9,60	176	450	115	150	426
ZRF 55 / 400 OX3	5.6		3	1800	14,40	265	450	115	240	426
ZRF 55 / 400 OX4	7.6		4	2000	16,00	176	450	230	150	426
ZRF 55 / 400 OX6	11		6	3000	24,00	265	450	230	240	426
ZRF 55 / 500 OX1	3	1200 - 180	1	800	5,80	89	550	115	64	526
ZRF 55 / 500 OX2	4.6		2	1600	11,60	176	550	115	150	526
ZRF 55 / 500 OX3	7.2		3	2400	17,40	265	550	115	240	526
ZRF 55 / 500 OX4	8.9		4	2600	19,00	176	550	230	150	526
ZRF 55 / 500 OX6	13.2		6	3800	28,50	265	550	230	240	526
ZRF 55 / 600 OX1	3.5	1500 - 200	1	1000	7,00	89	650	115	64	626
ZRF 55 / 600 OX2	5.8		2	2000	14,00	176	650	115	150	626
ZRF 55 / 600 OX3	7.6		3	3000	21,00	265	650	115	240	626
ZRF 55 / 600 OX4	10.4		4	3200	22,50	176	650	230	150	626
ZRF 55 / 600 OX6	15		6	5000	34,00	265	650	230	240	626

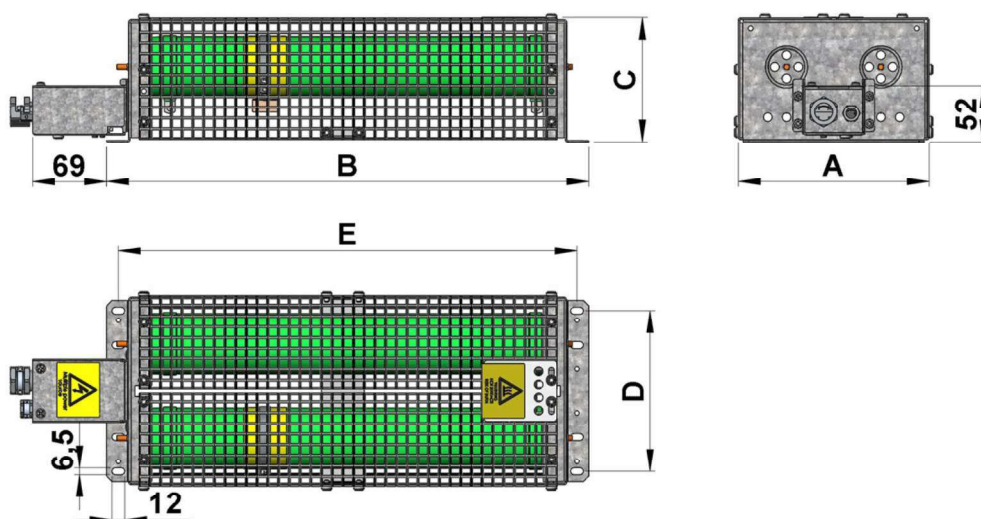

Each SIGMA-MODULE is supplied with resistor components corresponding to the actual load and according to the mechanical sizes shown in the table. In principle as many components as necessary can be mounted together. The modules can be supplied as open resistors (only resistor and mounting brackets) or with protection grating according to IP20 and with a ceramic housing connector or with a connector box. Further more it is possible to have a thermostat which works as a temperature watch and high voltage versions >400VDC.

Thermostats

The thermostat, which surveys the temperature on the resistor element, is equipped with a NC switch for warning the frequency converter if the resistor is over loaded. It is mounted on lower side of one or more resistor elements and has directly thermal contact. The standard switching temperature is 260°C. Other (lower) temperatures are possible. If the thermostat is connected to the coil of a contactor, it can work as a thermal fuse. The switch is specified to 250/380VAC, 10/5A. The thermostat is isolated from the resistor via the ceramic housing. For voltages >400VDC the thermostat is isolated with a double MICA strip.

Σ Wirewound Brake Resistors UL Approved

Type	Pnom	Max Surface Temp. @ 40°C	1s/120s	5s/120s	10s/120s	40s/120s	Ohmic Range
	W	°C	kW	kW	kW	kW	Ω - kΩ
ZRF 55/300 0A81	430	375	8	4.8	3.5	1.2	1.0 - 0.4
ZRF 55/400 0A81	575	375	12	6	4.5	1.6	1.5 - 0.9
ZRF 55/500 0A81	725	375	18	8	6	2	2.2 - 1.2
ZRF 55/600 0A81	875	375	22	10	7	2.6	2.5 - 1.5
ZRF 55/400 0A82	900	375	24	12	9	2.7	3.0 - 1.8
ZRF 55/500 0A82	1130	375	36	16	12	3.3	4.0 - 2.2
ZRF 55/600 0A82	1365	375	44	20	14	3.9	5.5 - 3.0
ZRF 55/500 0A83	1545	375	54	24	18	4.5	6.5 - 3.6
ZRF 55/600 0A83	1860	375	66	30	21	5.5	6.8 - 4.5
ZRF 55/500 0A84	2060	375	72	32	24	6	2.0 - 4.8
ZRF 55/600 0A84	2480	375	88	40	28	9.5	2.8 - 6.2
ZRF 55/500 0A86	3065	375	105	56	36	9	3.3 - 6.8
ZRF 55/600 0A86	3690	375	130	60	52	11	3.5 - 10
ZRF 55/500 0A89	4030	375	160	70	54	12	1.5 - 6.8
ZRF 55/600 0A89	4855	375	180	85	60	14	1.8 - 10

MATERIALS :

Resistor:

Ceramic Core: 20-30 mm Ø Steatite C221
55 mm Ø Corderite
Resistor Wire: CrAlFe / CrNi / CuNi
Terminals: FeNi42
Coating: Aluminiumphosphate

Resistor Cage:

Mounting Bracket: Steel, hot galvanized
1,5mm
Protection grating: Steel, hot galvanized
1,5mm, perforated
Connectors: Porcelain
Cables: Silicone (Silicone less possible)

Resistor tolerance:

Standard: ± 10%

Type	A ± 2	B1 ± 2	C ± 2	D ± 1	E ± 3	F ± 3	Weight
	mm	mm	mm	mm	mm	mm	kg
ZRF 55/300 0A81	97	350	142	64	326	435	2.5
ZRF 55/400 0A81	97	450	142	64	426	535	3
ZRF 55/500 0A81	97	550	142	64	526	635	3.5
ZRF 55/600 0A81	97	650	142	64	626	735	4
ZRF 55/400 0A82	188	450	142	150	426	535	5
ZRF 55/500 0A82	188	550	142	150	526	635	5.5
ZRF 55/600 0A82	188	650	142	150	626	735	6.5
ZRF 55/500 0A83	279	550	142	240	526	635	7.8
ZRF 55/600 0A83	279	650	142	240	626	735	8.5
ZRF 55/500 0A84	188	550	252	150	526	635	9.5
ZRF 55/600 0A84	188	650	252	150	626	735	11
ZRF 55/500 0A86	274	550	252	240	526	635	14
ZRF 55/600 0A86	274	650	252	240	626	735	15
ZRF 55/500 0A89	274	550	342	240	526	635	17
ZRF 55/600 0A89	274	650	342	240	626	735	18

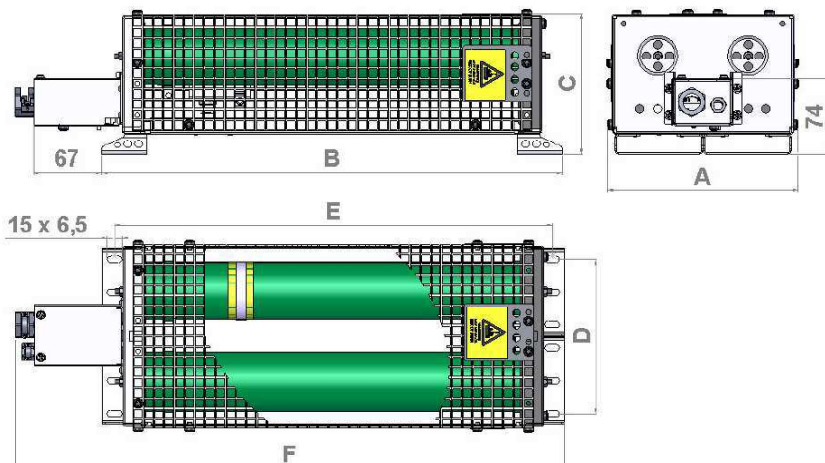

TYPE IDENTIFICATION:

ZRF 55/400 032 47R

- Resistor value (F. eks. 47Ω)
- Number of resistor elements
- 1: MB
- 2: MB + PC
- 3: MB + PC + PG
- 4: MB + PC + PG + TW
- 5: MB + PC + PG + CB
- 6: MB + PC + PG + CB + TW
- 7: like 5, but with Connector for >400VDC
- 8: like 6, but with connector for >400VDC
- Length of resistor element
- Diameter of resistor element
- F: Normally Wire wound; I: Non-inductive
- R: Standard; B: Edgewound

MB: Mounting Bracket PC: Porcelain connector PG: Protecting Grating TW: Temperature Watch CB: Connector Box

Mounting Brackets for Round Style Resistors

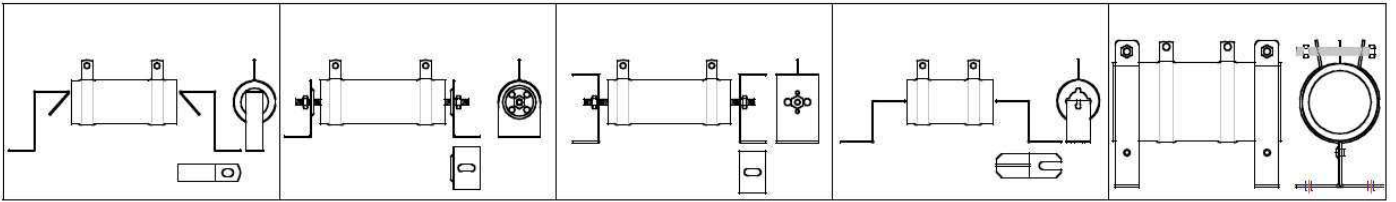

Mounting Brackets		Complete Sets					
Profile 1		Profile 1		30Ø Profile 3	30Ø Profile 3		55Ø
10mmØ/12mmØ:	R101	20mmØ:	R701/Length	R801/Length	30mmØ:	R107	R901
15mmØ:	R102	30mmØ:	R702/Length	(Thru bolts)			
20mmØ:	R103	55mmØ:	R703/Length				
24mmØ:	R104						
30mmØ:	R105						

Mounting Brackets for Oval Shape Style Resistors

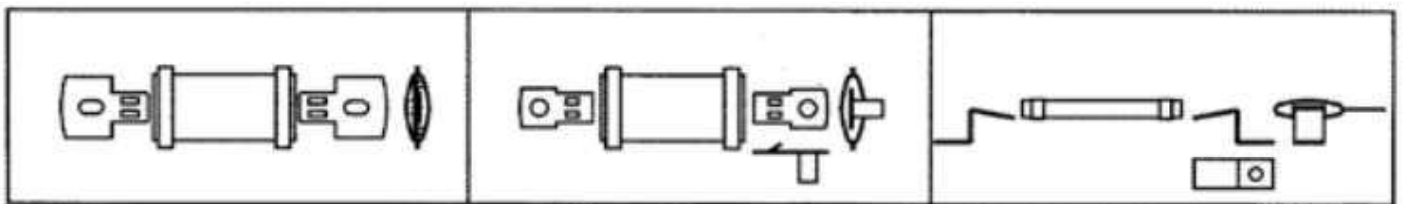

Mounting Brackets					
20mm	-	20mm	R120	20mm	R122
27mm:	R123	27mm	R120	27mm	R122
45mm	R124	45mm	-	45mm	-

Mounting brackets for Wirewound resistors need to be ordered separately.

All Danotherm Resistors can be equipped with a thermal model, which makes it possible to calculate the TEMPERATURE RISE during a specified load. Particularly by pulse loads it is possible to simulate the temperature rise by using a program as PSpice.

You can ask DANOTHERM to simulate or ask for the thermal model of your resistor to do the simulation your self.

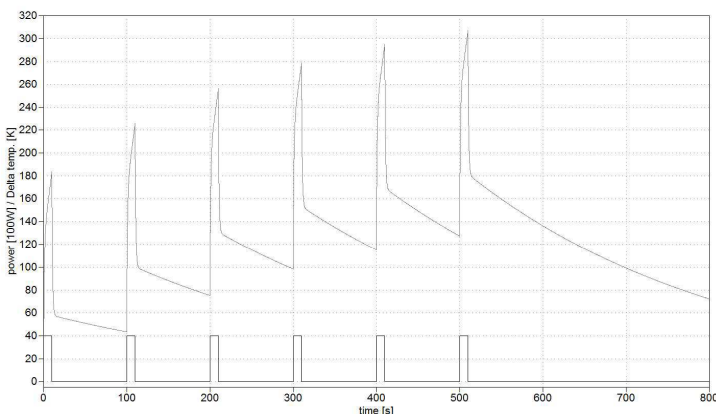
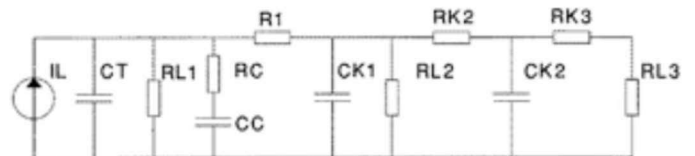

Danotherm Electric A/S
 Naesbyvej 20
 DK-2610 Roedovre
 Denmark
 CVR 1012 6061

DAN EN 16.5041.R1
 09112016