



TECHNICAL CATALOGUE AC DRIVES



EMOTRON VFX/FDU 2.0
0.37 - 3000 KW, 230 - 690 V
IP20, IP21 AND IP54

emotron

DEDICATED DRIVE



A CG Product

Optimized operation and full control

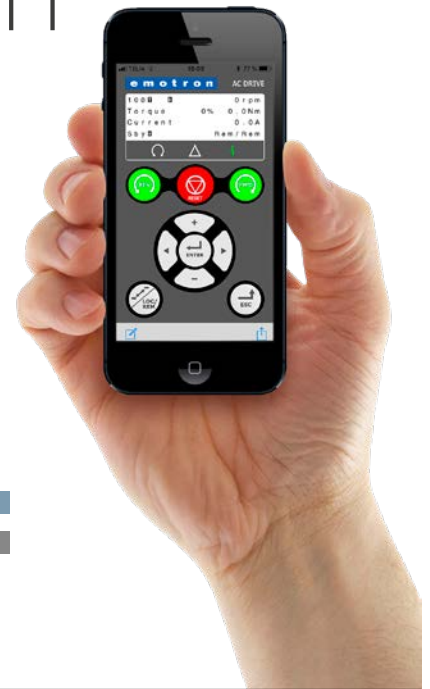





CONTENTS

Emotorn VFX	page 3		General specifications	page 19	
Emotorn FDU	page 11		Standard options	page 27	

General information overview for Emotron FDU 2.0 and VFX 2.0

Emotorn FDU 2.0/VFX 2.0	IP2Y Frame size A3 - C3	IP20/21 Frame sizes C2 - FA2/C2(69)-F2(69)	IP54/20 Framesizes B - O/C69-T69
Power range	0.37 - 18.5 / 0.5 - 25 hp	5.5 - 200 kW / 7.5 - 250 hp	0.37 - 3000 kW / 0.5 - 4000 hp
Voltage range	3 ph, 230 - 480 V	3 ph, 230 - 480 V	3 ph, 230 - 690 V
IP class	IP20	IP20/21	IP54/20
Control mode	VFX : Direct torque control or V/Hz, FDU: V/Hz		
AC/DC choke	Optional	Standard	Standard
EMC filter	C3 is standard C2 is optional		
Coated boards	Standard	Standard	Optional
Detachable control panel - multilanguage	Standard	Standard	Standard
Options	Encoder PTC Extended IO Safe stop Standby supply	Encoder PTC/PT100 Extended IO Safe stop Standby supply External control panel CRIO (only VFX)	
Serial communication option	RS232/485 (Modbus RTU)	RS232/485 (Modbus RTU)	
Communication options	DeviceNet, Modbus/TCP, Profibus Profinet IO, EtherNet IP EtherCAT, CANopen		
Liquid cooling	N.a.	N.a.	Optional for frame sizes E and up
IP21 top cover	N.a.	Optional	N.a.

CE certification		All sizes	
UL certification cULus certification		UL/cUL approved	UL/cUL approved
Marine certification		DNV (pending)	DNV BV for framesize E and up
EAC (replacing GOST R)		All sizes	

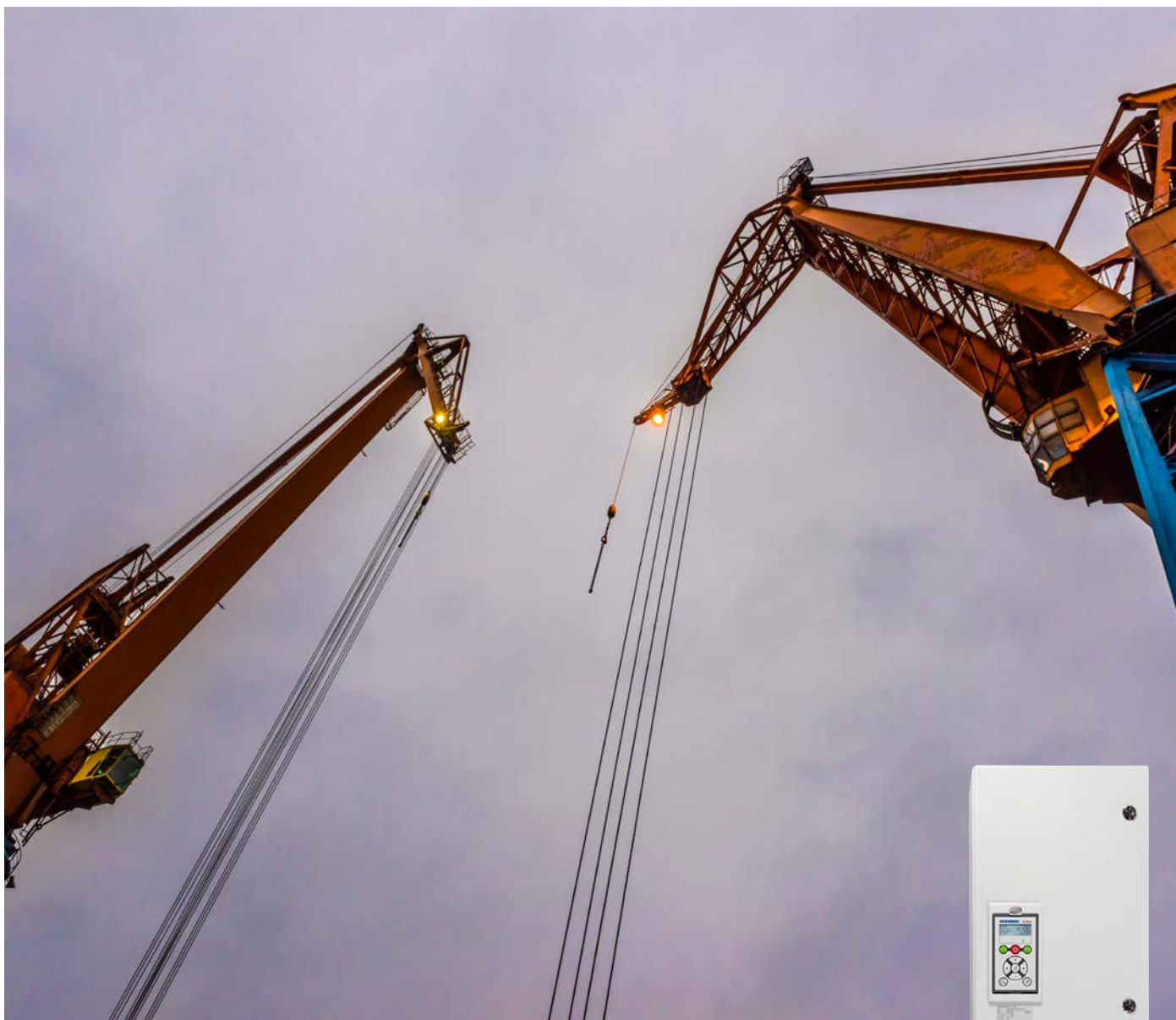

Emotron VFX 2.0 High dynamics for demanding applications

The Emotron VFX 2.0 AC drive optimizes your process and prevents damage and downtime. The combination of direct torque control, accurate speed control, and efficient vector braking makes it the ideal solution for all dynamic and constant torque applications, such as cranes, crushers, mills, mixers, and centrifuges.

MAIN FEATURES

- NEW - Control panel with Real time clock. Optional Bluetooth communication.
- Available as robust and certified IP54 metal construction or IP20/21 version.
- All drive sizes are delivered with a built-in Category C3 EMC-filter as standard. C3 requirements are fulfilled with 80 m motor cable (IP2Y= 25m).
- Direct torque control reacts extremely quickly and eliminates disturbances due to abrupt load changes.
- Load monitor function included as standard.
- UL (UL 840) approved version available (not IP2Y).
- Marine (DNV-GL & BV) approved version available (not IP2Y, IP2x).
- Integrated vector braking ensures quick and controlled stops, increasing productivity and safety.
- Built-in brake chopper is standard for IP2Y models and available as option for all other.
- Temp / Speed controlled fans assures less noise, a more even drive temperature and higher drive efficiency.
- Detachable multi-language control panel included as standard. Following languages are supported in the control panel: English, Swedish, Dutch, German, French, Spanish, Russian, Italian, Czech, Turkish and Polish.
- Operation parameters can be set in your process units, for example m/sec, tons/h or cycles/min.
- Removable control panel with own memory means it is easy to transfer or copy settings.
- Liquid cooled version available for sizes above 90 A.

Emotron VFX 2.0 - IP54 version

Typical motor power at 3-phase mains voltage 230 V (Model 48-430 and up also available as IP20).

VFX Model	Max. output current [A]*	Normal duty (120%, 1 min. every 10 min.)			Heavy duty (150%, 1 min. every 10 min.)			Frame size **	IP class	
		Power @ 230V [kW]	Power @ 230V [hp]	Rated current [A]	Power @ 230V [kW]	Power @ 230V [hp]	Rated current [A]			
VFX48-003-54	3.8	0.37	0.5	2.5	0.37	0.5	2.0	B	IP54 wall mounted	
VFX48-004-54	6.0	0.75	1	4.0	0.55	0.75	3.2			
VFX48-006-54	9.0	1.1	1.5	6.0	0.75	1	4.8			
VFX48-008-54	11.3	1.5	2	7.5	1.1	1.5	6.0			
VFX48-010-54	14.3	2.2	3	9.5	1.5	2	7.6			
VFX48-013-54	19.5	2.2	3	13.0	2.2	3	10.4			
VFX48-018-54	27.0	4	5	18.0	3	3	14.4			
VFX48-026-54	39	5.5	7.5	26	4	5	21	C		
VFX48-031-54	46	7.5	10	31	5.5	7.5	25			
VFX48-037-54	55	7.5	10	37	7.5	10	29.6			
VFX48-046-54	69	11	15	46	7.5	10	37	D		
VFX48-061-54	92	15	20	61	11	15	49			
VFX48-074-54	111	18.5	25	74	15	20	59			
VFX48-090-54	108	22	30	90	18.5	25	72	E		
VFX48-109-54	131	30	40	109	22	30	87			
VFX48-146-54	175	37	50	146	30	40	117			
VFX48-175-54	210	45	60	175	37	50	140	F		
VFX48-210-54	252	55	75	210	45	60	168			
VFX48-250-54	300	75	100	250	55	75	200	FA		
VFX48-295-54	354	90	125	295	75	100	236			
VFX48-365-54	438	110	150	365	90	125	292	IP20 module or IP54/23 cabinet		
VFX48-430-IP	516	110	150	430	110	125	344			
VFX48-500-IP	600	160	200	500	110	150	400		H (2)	
VFX48-600-IP	720	200	250	600	132	200	480		I (3)	
VFX48-650-IP	780	200	250	650	160	200	520			
VFX48-750-IP	900	220	300	750	200	250	600			
VFX48-860-IP	1032	250	350	860	220	300	688		J (4)	
VFX48-1K0-IP	1200	300	400	1000	250	350	800			
VFX48-1K15-IP	1380	355	450	1150	250	400	920		KA (5)	
VFX48-1K25-IP	1500	400	500	1250	315	400	1000			
VFX48-1K35-IP	1620	400	550	1350	355	450	1080		K (6)	
VFX48-1K5-IP	1800	450	600	1500	400	500	1200			
VFX48-1K75-IP	2100	560	750	1750	450	600	1400		L (7)	
VFX48-2K0-IP	2400	630	800	2000	500	650	1600			
VFX48-2K25-IP	2700	710	900	2250	560	750	1800		N (9)	
VFX48-2K5-IP	3000	800	1000	2500	630	800	2000			
Larger sizes available on request										

* Available for a limited time and as long as drive temperature permits. Rated data at 40 °C ambient temperature

** Number in parenthesis, e.g. H(2), indicates number of parallel power modules.

IP = Available as IP20 module or mounted in IP23 or IP54 cabinet.

Emotron VFX 2.0 - IP54 version

Typical motor power at 3-phase mains voltage 400 V and 460 V (Model 48-430 and up also available as IP20).

VFX Model	Max. output current [A]*	Normal duty (120%, 1 min. every 10 min.)			Heavy duty (150%, 1 min. every 10 min.)			Frame size **	IP class
		Power @ 400V [kW]	Power @ 460V [hp]	Rated current [A]	Power @ 400V [kW]	Power @ 460V [hp]	Rated current [A]		
VFX48-003-54	3.8	0.75	1	2.5	0.55	1	2.0	B	IP 54 wall mounted
VFX48-004-54	6.0	1.5	2	4.0	1.1	1.5	3.2		
VFX48-006-54	9.0	2.2	3	6.0	1.5	2	4.8		
VFX48-008-54	11.3	3	3	7.5	2.2	3	6.0		
VFX48-010-54	14.3	4	5	9.5	3	3	7.6		
VFX48-013-54	19.5	5.5	7.5	13.0	4	5	10.4		
VFX48-018-54	27.0	7.5	10	18.0	5.5	7.5	14.4		
VFX48-026-54	39	11	15	26	7.5	10	21	C	
VFX48-031-54	46	15	20	31	11	15	25		
VFX48-037-54	55	18.5	25	37	15	20	29.6		
VFX48-046-54	69	22	30	46	18.5	25	37	D	
VFX48-061-54	92	30	40	61	22	30	49		
VFX48-074-54	111	37	50	74	30	40	59		
VFX48-090-54	108	45	60	90	37	50	72	E	
VFX48-109-54	131	55	75	109	45	60	87		
VFX48-146-54	175	75	100	146	55	75	117		
VFX48-175-54	210	90	125	175	75	100	140	F	
VFX48-210-54	252	110	150	210	90	125	168		
VFX48-250-54	300	132	200	250	110	150	200		
NEW NEW VFX48-295-54	354	160	250	295	132	200	236		
VFX48-365-54	438	200	300	365	160	250	292	FA	
VFX48-430-IP	516	220	350	430	200	250	344	H (2)	IP20 module or IP54/23 cabinet
VFX48-500-IP	600	250	400	500	220	350	400		
VFX48-600-IP	720	315	500	600	250	400	480		
VFX48-650-IP	780	355	550	650	315	400	520		
VFX48-750-IP	900	400	600	750	355	500	600		
VFX48-860-IP	1032	450	700	860	400	550	688		
VFX48-1K0-IP	1200	560	800	1000	450	650	800		
VFX48-1K15-IP	1380	630	900	1150	500	750	920		
VFX48-1K25-IP	1500	710	1000	1250	560	800	1000		
VFX48-1K35-IP	1620	710	1100	1350	600	900	1080		
VFX48-1K5-IP	1800	800	1250	1500	630	1000	1200		
VFX48-1K75-IP	2100	900	1500	1750	800	1200	1400		
VFX48-2K0-IP	2400	1120	1700	2000	900	1300	1600		
VFX48-2K25-IP	2700	1250	1900	2250	1000	1500	1800		
VFX48-2K5-IP	3000	1400	2100	2500	1120	1700	2000		
Larger sizes available on request									

* Available for a limited time and as long as drive temperature permits. Rated data at 40 °C ambient temperature

** Number in parenthesis, e.g. H(2), indicates number of parallel power modules.

IP = Available as IP20 module or mounted in IP23 or IP54 cabinet.

Emotron VFX 2.0 - IP54 version

Typical motor power at 3-phase mains voltage 525 V Model 69-250 and up also available as IP20).

VFX Model	Max. output current [A]*	Normal duty (120%, 1 min. every 10 min.)		Heavy duty (150%, 1 min. every 10 min.)		Frame size **	IP class
		Power @525 V [kW]	Rated current [A]	Power @525 V [kW]	Rated current [A]		
VFX52-003-54	3.8	1.1	2.5	1.1	2.0	B	IP54 wall mounted
VFX52-004-54	6.0	2.2	4.0	1.5	3.2		
VFX52-006-54	9.0	3	6.0	2.2	4.8		
VFX52-008-54	11.3	4	7.5	3	6.0		
VFX52-010-54	14.3	5.5	9.5	4	7.6		
VFX52-013-54	19.5	7.5	13.0	5.5	10.4		
VFX52-018-54	27.0	11	18.0	7.5	14.4		
VFX52-026-54	39	15	26	11	21	C	
VFX52-031-54	46	18.5	31	15	25		
VFX52-037-54	55	22	37	18.5	29.6		
VFX52-046-54	69	30	46	22	37		
VFX52-061-54	92	37	61	30	49	D	
VFX52-074-54	111	45	74	37	59		
NEW VFX69-082-54	98	55	82	45	66	F69	
VFX69-090-54	108	55	90	45	72		
VFX69-109-54	131	75	109	55	87		
VFX69-146-54	175	90	146	75	117		
VFX69-175-54	210	110	175	90	140		
VFX69-200-54	240	132	200	110	160		
VFX69-250-IP	300	160	250	132	200	H69 (2)	
VFX69-300-IP	360	200	300	160	240		
VFX69-375-IP	450	250	375	200	300		
VFX69-400-IP	480	250	400	220	320		
VFX69-430-IP	516	300	430	250	344	I69 (3)	
VFX69-500-IP	600	315	500	300	400		
VFX69-595-IP	720	400	600	315	480	J69 (4)	
VFX69-650-IP	780	450	650	355	520		
VFX69-720-IP	864	500	720	400	576		
VFX69-800-IP	960	560	800	450	640		
VFX69-995-IP	1200	630	1000	500	800		
VFX69-1K2-IP	1440	800	1200	630	960		
VFX69-1K4-IP	1680	1000	1400	800	1120		
VFX69-1K6-IP	1920	1100	1600	900	1280		
VFX69-1K8-IP	2160	1300	1800	1000	1440		
VFX69-2K0-IP	2400	1400	2000	1100	1600		
VFX69-2K2-IP	2640	1600	2200	1200	1760		
VFX69-2K4-IP	2880	1700	2400	1400	1920		
VFX69-2K6-IP	3120	1900	2600	1500	2080		
VFX69-2K8-IP	3360	2000	2800	1600	2240		
VFX69-3K0-IP	3600	2200	3000	1700	2400		

* Available for a limited time and as long as drive temperature permits. Rated data at 40 °C ambient temperature.

** Number in parenthesis, e.g. H69 (2), indicates number of parallel power modules.

IP = Available as IP20 module or mounted in IP23 or IP54 cabinet.

Emotron VFX 2.0 - IP54 version

Typical motor power at 3-phase mains voltage 575 V and 690 V (Model 69-250 and up also available as IP20).

	VFX Model	Max output current [A]*	Normal duty (120%, 1 min. every 10 min.)			Heavy duty (150%, 1 min. every 10 min.)			Frame size **	IP class
			Power @ 575V [hp]	Power @ 690V [kW]	Rated current [A]	Power @ 575 V [hp]	Power @ 690V [kW]	Rated current [A]		
NEW	VFX69-002-54	3.2	1.5	1.5	2	1	0.75	1.6	C69	IP54 wall-mounted
NEW	VFX69-003-54	4.8	2	2.2	3	1.5	1.5	2.4		
NEW	VFX69-004-54	6.4	3	3	4	2	2.2	3.2		
NEW	VFX69-006-54	9.6	4	4	6	3	3	4.8		
NEW	VFX69-008-54	12.8	5	5.5	8	4	4	6.4		
NEW	VFX69-010-54	16	7.5	7.5	10	5	5.5	8		
NEW	VFX69-013-54	20.8	10	11	13	7.5	7.5	10.4		
NEW	VFX69-018-54	29	15	15	18	10	11	14.4		
NEW	VFX69-021-54	34	20	18.5	21	15	15	16.8		
NEW	VFX69-025-54	40	25	22	25	20	18.5	20		
NEW	VFX69-033-54	53	30	30	33	25	22	26	D69	
NEW	VFX69-042-54	67	40	37	42	30	30	34		
NEW	VFX69-050-54	80	50	45	50	40	37	40		
NEW	VFX69-058-54	93	60	55	58	40	45	46		
NEW	VFX69-082-54	98	75	75	82	60	55	66		
	VFX69-090-54	108	75	90	90	60	75	72	F69	
	VFX69-109-54	131	100	110	109	75	90	87		
	VFX69-146-54	175	125	132	146	100	110	117		
	VFX69-175-54	210	150	160	175	125	132	140		
	VFX69-200-54	240	200	200	200	150	160	160		
	VFX69-250-IP	300	250	250	250	200	200	200		
	VFX69-300-IP	360	300	315	300	250	250	240		
	VFX69-375-IP	450	350	355	375	300	315	300		
	VFX69-400-IP	480	400	400	400	300	315	320		
	VFX69-430-IP	516	400	450	430	350	315	344	I69 (3)	
	VFX69-500-IP	600	500	500	500	400	355	400		
	VFX69-595-IP	720	600	600	600	500	450	480		
	VFX69-650-IP	780	650	630	650	550	500	520	J69 (4)	
	VFX69-720-IP	864	750	710	720	600	560	576		
	VFX69-800-IP	960	850	800	800	650	630	640	IP20 module or IP54/23 cabinet	
	VFX69-905-IP	1080	950	900	900	750	710	720		
	VFX69-995-IP	1200	1000	1000	1000	850	800	800		
	VFX69-1K2-IP	1440	1200	1200	1200	1000	900	960		
	VFX69-1K4-IP	1680	1500	1400	1400	1200	1120	1120		
	VFX69-1K6-IP	1920	1700	1600	1600	1300	1250	1280		
	VFX69-1K8-IP	2160	1900	1800	1800	1500	1400	1440		
	VFX69-2K0-IP	2400	2100	2000	2000	1700	1600	1600		
	VFX69-2K2-IP	2640	2300	2200	2200	1800	1700	1760		
	VFX69-2K4-IP	2880	2500	2400	2400	2000	1900	1920		
	VFX69-2K6-IP	3120	2700	2600	2600	2200	2000	2080		
	VFX69-2K8-IP	3360	3000	2800	2800	2400	2200	2240		
	VFX69-3K0-IP	3600	3200	3000	3000	2500	2400	2400		

* Available for a limited time and as long as drive temperature permits. Rated data at 40 °C ambient temperature

** Number in parenthesis, e.g. H69 (2), indicates number of parallel power modules.

IP = Available as IP20 module or mounted in IP23 or IP54 cabinet.

Emotron VFX 2.0 - IP20 version

Typical motor power at 3-phase mains voltage 230 V.

VFX Model	Max. output current [A]*	Normal duty (120%, 1 min every 10 min)			Heavy duty (150%, 1 min every 10 min)			Frame size
		Power @ 230V [kW]	Power @230V [hp]	Rated current [A]	Power @ 230V [kW]	Power @230V [hp]	Rated current [A]	
VFX48-2P5-2Y	3.8	0.37	0.5	2.5	0.25	0.33	2.0	A3
VFX48-3P4-2Y	5.1	0.55	0.75	3.4	0.37	0.5	2.7	
VFX48-4P1-2Y	6.2	0.75	1	4.1	0.55	0.75	3.3	
VFX48-5P6-2Y	8.4	1.1	1.5	5.6	0.75	1	4.5	
VFX48-7P2-2Y	10.8	1.1	1.5	7.2	1.1	1.5	5.8	
VFX48-9P5-2Y	14.3	2.2	3	9.5	1.1	1.5	7.6	
VFX48-012-2Y	18	2.2	3	12	2.2	3.0	9.6	
VFX48-016-2Y	24	4.0	5.5	16	2.2	3.0	12.8	B3
VFX48-023-2Y	34.5	5.5	7.5	23	4.0	5.5	18.4	C3
VFX48-032-2Y	46.5	7.5	10	31	5.5	7.5	24.8	
VFX48-038-2Y	56	11	15	38	7.5	9.6	30.4	
VFX48-025-20	38	5.5	7.5	25	4	5	20	C2
VFX48-030-20	45	7.5	10	30	5.5	7.5	24	
VFX48-036-20	54	7.5	10	36	7.5	10	29	
VFX48-045-20	68	11	15	45	7.5	10	36	
VFX48-058-20	68	15	20	58	11	15	46	
VFX48-060-20	90	15	20	60	11	15	48	
VFX48-072-20	108	18.5	25	72	15	20	58	D2
VFX48-088-20	132	22	30	88	18.5	25	70	
VFX48-105-20	132	30	40	105	22	30	84	
VFX48-142-20	170	37	50	142	30	40	114	E2
VFX48-171-20	205	45	60	171	37	50	137	
VFX48-205-20	246	55	75	205	45	60	164	F2
VFX48-244-20	293	75	100	244	55	75	195	
VFX48-293-20	352	90	125	293	75	100	235	
VFX48-365-20	438	110	150	365	90	125	292	FA2

* Available for a limited time and as long as drive temperature permits. Rated data at 40 °C ambient temperature.



Emotron VFX 2.0 - IP20 version

Typical motor power at 3-phase mains voltage 400 and 460 V.

VFX Model	Max. output current [A]*	Normal duty (120%, 1 min every 10 min)			Heavy duty (150%, 1 min every 10 min)			Frame size
		Power @ 400V [kW]	Power @460V [hp]	Rated current [A]	Power @ 400V [kW]	Power @460V [hp]	Rated current [A]	
VFX48-2P5-2Y	3.8	0.75	1	2.5	0.55	0.75	2.0	A3
VFX48-3P4-2Y	5.1	1.1	1.5	3.4	0.75	1	2.7	
VFX48-4P1-2Y	6.2	1.5	2	4.1	1.1	1.5	3.3	
VFX48-5P6-2Y	8.4	2.2	3	5.6	1.5	2	4.5	
VFX48-7P2-2Y	10.8	3.0	4	7.2	2.2	3	5.8	
VFX48-9P5-2Y	14.3	4.0	5	9.5	3.0	4	7.6	
VFX48-012-2Y	18	5.5	7.5	12	4.0	5	9.6	
VFX48-016-2Y	24	7.5	10	16	5.5	7.5	12.8	B3
VFX48-023-2Y	34.5	11	15	23	7.5	10	18.4	C3
VFX48-032-2Y	46.5	15	20	31	11	15	24.8	
VFX48-038-2Y	56	18.5	25	38	15	20	30.4	C2
VFX48-025-20	38	11	15	25	7.5	10	20	
VFX48-030-20	45	15	20	30	11	15	24	
VFX48-036-20	54	18.5	25	36	15	20	29	
VFX48-045-20	68	22	30	45	18.5	25	36	
VFX48-058-20	68	30	40	58	22	30	46	D2
VFX48-060-20	90	30	40	60	22	30	48	
VFX48-072-20	108	37	50	72	30	40	58	
VFX48-088-20	132	45	60	88	37	50	70	
VFX48-105-20	132	55	75	105	45	60	84	E2
VFX48-142-20	170	75	100	142	55	75	114	
VFX48-171-20	205	90	125	171	75	100	137	
VFX48-205-20	246	110	150	205	90	125	164	F2
VFX48-244-20	293	132	200	244	110	150	195	
NEW VFX48-293-20	352	160	250	293	132	200	235	FA2
NEW VFX48-365-20	438	200	300	365	160	250	292	

* Available for a limited time and as long as drive temperature permits. Rated data at 40 °C ambient temperature.



Emotron VFX 2.0 - IP20 version

Typical motor power at 3-phase mains voltage 575 V and 690 V.

VFX Model	Max. output current [A]*	Normal duty (120%, 1 min. every 10 min.)			Heavy duty (150%, 1 min. every 10 min.)			Frame size
		Power @ 575V [hp]	Power @ 690V [kW]	Rated current [A]	Power @ 575 V [hp]	Power @ 690V [kW]	Rated current [A]	
NEW VFX69-002-20	3.2	1.5	1.5	2	1	0.75	1.6	C2(69)
NEW VFX69-003-20	4.8	2	2.2	3	1.5	1.5	2.4	
NEW VFX69-004-20	6.4	3	3	4	2	2.2	3.2	
NEW VFX69-006-20	9.6	4	4	6	3	3	4.8	
NEW VFX69-008-20	12.8	5	5.5	8	4	4	6.4	
NEW VFX69-010-20	16	7.5	7.5	10	5	5.5	8	
NEW VFX69-013-20	20.8	10	11	13	7.5	7.5	10.4	
NEW VFX69-018-20	29	15	15	18	10	11	14.4	
NEW VFX69-021-20	34	20	18.5	21	15	15	16.8	
NEW VFX69-025-20	40	25	22	25	20	18.5	20	
NEW VFX69-033-20	53	30	30	33	25	22	26	D2(69)
NEW VFX69-042-20	67	40	37	42	30	30	34	
NEW VFX69-050-20	80	50	45	50	40	37	40	
NEW VFX69-058-20	93	60	55	58	40	45	46	

* Available for a limited time and as long as drive temperature permits. Rated data at 40 °C ambient temperature.





Emotron FDU 2.0 Secure the flow and save energy

The Emotron FDU 2.0 AC drive is specially developed for controlling variable torque loads such as flow and pressure applications. It continuously adapts motor speed to the level required, minimizing energy consumption and wear. A unique monitoring functionality protects your process from damage and unplanned downtime. Typical applications are pumps, fans, compressors, and blowers.

MAIN FEATURES

- NEW - Control panel with Real time clock. Optional Bluetooth communication.
- Available as robust and certified IP54 metal construction or IP20/21 version.
- All drive sizes are delivered with built-in Category C3 EMC-filter as standard. C3 requirements are fulfilled with 80 m motor cable (IP2Y=25m).
- Soft starts minimize start currents and linear stops prevent water hammer.
- One Emotron FDU can control up to seven pumps/fans without external control systems.
- Energy saving function pauses the motor when it is not required to run to maintain pressure.
- Efficiency is increased by setting the pump to run at full speed at certain intervals to rinse out sludge.
- Temp/Speed controlled fans assures less noise, a more even drive temperature and higher efficiency.
- Load monitor function included as standard.
- Detachable multi-language control panel included as standard. Following languages are supported in the control panel: English, Swedish, Dutch, German, French, Spanish, Russian, Italian, Czech, Turkish and Polish.
- Operation parameters can be set in your process units, for example m³/min. and bar.
- Removable control panel with own memory means it is easy to transfer or copy settings.
- UL (UL 840) approved version available (not IP2Y).
- Marine (DNV-GL & BV) approved version available (not IP2Y, IP2X).
- Liquid cooled version available for sizes above 90 A.

Emotron FDU 2.0 - IP54 version

Typical motor power at 3-phase mains voltage 230 V (Model 48-430 and up also available as IP20).

FDU Model	Max. output current [A]*	Normal duty (120%, 1 min. every 10 min.)			Heavy duty (150%, 1 min. every 10 min.)			Frame size **	IP class
		Power @ 230V [kW]	Power @ 230V [hp]	Rated current [A]	Power @ 230V [kW]	Power @ 230V [hp]	Rated current [A]		
FDU48-003-54	3.0	0.37	0.5	2.5	0.37	0.5	2.0	B	IP54 wall mounted
FDU48-004-54	4.8	0.75	1	4.0	0.55	0.75	3.2		
FDU48-006-54	7.2	1.1	1.5	6.0	0.75	1	4.8		
FDU48-008-54	9.0	1.5	2	7.5	1.1	1.5	6.0		
FDU48-010-54	11.4	2.2	3	9.5	1.5	2	7.6		
FDU48-013-54	15.6	2.2	3	13.0	2.2	3	10.4		
FDU48-018-54	21.6	4	5	18.0	3	3	14.4		
FDU48-026-54	31	5.5	7.5	26	4	5	21	C	
FDU48-031-54	37	7.5	10	31	5.5	7.5	25		
FDU48-037-54	44	7.5	10	37	7.5	10	29.6		
FDU48-046-54	55	11	15	46	7.5	10	37		
FDU48-061-54	73	15	20	61	11	15	49	D	
FDU48-074-54	89	18.5	25	74	15	20	59		
FDU48-090-54	108	22	30	90	18.5	25	72	E	
FDU48-109-54	131	30	40	109	22	30	87		
FDU48-146-54	175	37	50	146	30	40	117		
FDU48-175-54	210	45	60	175	37	50	140		
FDU48-210-54	252	55	75	210	45	60	168	F	
FDU48-250-54	300	75	100	250	55	75	200		
FDU48-295-54	354	90	125	295	75	100	236	FA	
FDU48-365-54	438	110	150	365	90	125	292		
FDU48-430-IP	516	110	150	430	110	125	344	H (2)	IP20 module or IP54/23 cabinet
FDU48-500-IP	600	160	200	500	110	150	400		
FDU48-600-IP	720	200	250	600	132	200	480	I (3)	
FDU48-650-IP	780	200	250	650	160	200	520		
FDU48-750-IP	900	220	300	750	200	250	600	J (4)	
FDU48-860-IP	1032	250	350	860	220	300	688		
FDU48-1K0-IP	1200	300	400	1000	250	350	800	KA (5)	
FDU48-1K15-IP	1380	355	450	1150	250	400	920		
FDU48-1K25-IP	1500	400	500	1250	315	400	1000	K (6)	
FDU48-1K35-IP	1620	400	550	1350	355	450	1080		
FDU48-1K5-IP	1800	450	600	1500	400	500	1200	L (7)	
FDU48-1K75-IP	2100	560	750	1750	450	600	1400		
FDU48-2K0-IP	2400	630	800	2000	500	650	1600	M (8)	
FDU48-2K25-IP	2700	710	900	2250	560	750	1800		
FDU48-2K5-IP	3000	800	1000	2500	630	800	2000	O (10)	

Larger sizes available on request

* Available for a limited time and as long as drive temperature permits. Rated data at 40 °C ambient temperature

** Number in parenthesis, e.g. H(2), indicates number of parallel power modules.

IP = Available as IP20 module or mounted in IP23 or IP54 cabinet.

Emotron FDU 2.0 - IP54 version

Typical motor power at 3-phase mains voltage 400 V and 460 V (Model 48-430 and up also available as IP20).

FDU Model	Max. output current [A]*	Normal duty (120%, 1 min. every 10 min.)			Heavy duty (150%, 1 min. every 10 min.)			Frame size **	IP class
		Power @ 400V [kW]	Power @ 460V [hp]	Rated current [A]	Power @ 400V [kW]	Power @ 460V [hp]	Rated current [A]		
FDU48-003-54	3.0	0.75	1	2.5	0.55	1	2.0	B	IP54 wall mounted
FDU48-004-54	4.8	1.5	2	4.0	1.1	1.5	3.2		
FDU48-006-54	7.2	2.2	3	6.0	1.5	2	4.8		
FDU48-008-54	9.0	3	3	7.5	2.2	3	6.0		
FDU48-010-54	11.4	4	5	9.5	3	3	7.6		
FDU48-013-54	15.6	5.5	7.5	13.0	4	5	10.4		
FDU48-018-54	21.6	7.5	10	18.0	5.5	7.5	14.4		
FDU48-026-54	31	11	15	26	7.5	10	21	C	
FDU48-031-54	37	15	20	31	11	15	25		
FDU48-037-54	44	18.5	25	37	15	20	29.6		
FDU48-046-54	55	22	30	46	18.5	25	37	D	
FDU48-061-54	73	30	40	61	22	30	49		
FDU48-074-54	89	37	50	74	30	40	59		
FDU48-090-54	108	45	60	90	37	50	72	E	
FDU48-109-54	131	55	75	109	45	60	87		
FDU48-146-54	175	75	100	146	55	75	117		
FDU48-175-54	210	90	125	175	75	100	140		
FDU48-210-54	252	110	150	210	90	125	168	F	
FDU48-250-54	300	132	200	250	110	150	200		
FDU48-295-54	354	160	250	295	132	200	236	FA	
FDU48-365-54	438	200	300	365	160	250	292		
FDU48-430-IP	516	220	350	430	200	250	344	H (2)	IP20 module or IP54/23 cabinet
FDU48-500-IP	600	250	400	500	220	350	400		
FDU48-600-IP	720	315	500	600	250	400	480	I (3)	
FDU48-650-IP	780	355	550	650	315	400	520		
FDU48-750-IP	900	400	600	750	355	500	600		
FDU48-860-IP	1032	450	700	860	400	550	688	J (4)	
FDU48-1K0-IP	1200	560	800	1000	450	650	800		
FDU48-1K15-IP	1380	630	900	1150	500	750	920	KA (5)	
FDU48-1K25-IP	1500	710	1000	1250	560	800	1000		
FDU48-1K35-IP	1620	710	1100	1350	600	900	1080	K (6)	
FDU48-1K5-IP	1800	800	1250	1500	630	1000	1200		
FDU48-1K75-IP	2100	900	1500	1750	800	1200	1400	L (7)	
FDU48-2K0-IP	2400	1120	1700	2000	900	1300	1600	M (8)	
FDU48-2K25-IP	2700	1250	1900	2250	1000	1500	1800	N (9)	
FDU48-2K5-IP	3000	1400	2100	2500	1120	1700	2000	O (10)	

Larger sizes available on request

* Available for a limited time and as long as drive temperature permits. Rated data at 40 °C ambient temperature.

** Number in parenthesis, e.g. H(2), indicates number of parallel power modules.

IP = Available as IP20 module or mounted in IP23 or IP54 cabinet.

Emotron FDU 2.0 - IP54 version

Typical motor power at 3-phase mains voltage 525 V (Model 69-250 and up also available as IP20).

FDU Model	Max. output current [A]*	Normal duty (120%, 1 min. every 10 min.)		Heavy duty (150%, 1 min. every 10 min.)		Frame size **	IP class
		Power @ 525 V [kW]	Rated current [A]	Power @ 525 V [kW]	Rated current [A]		
FDU52-003-54	3.0	1.1	2.5	1.1	2.0	B	IP54 wall mounted
FDU52-004-54	4.8	2.2	4.0	1.5	3.2		
FDU52-006-54	7.2	3	6.0	2.2	4.8		
FDU52-008-54	9.0	4	7.5	3	6.0		
FDU52-010-54	11.4	5.5	9.5	4	7.6		
FDU52-013-54	15.6	7.5	13.0	5.5	10.4		
FDU52-018-54	21.6	11	18.0	7.5	14.4		
FDU52-026-54	31	15	26	11	21	C	
FDU52-031-54	37	18.5	31	15	25		
FDU52-037-54	44	22	37	18.5	29.6		
FDU52-046-54	55	30	46	22	37		
FDU52-061-54	73	37	61	30	49	D	
FDU52-074-54	89	45	74	37	59		
NEW FDU69-082 -54	98	55	82	45	66	F69	
FDU69-090 -54	108	55	90	45	72		
FDU69-109-54	131	75	109	55	87		
FDU69-146-54	175	90	146	75	117		
FDU69-175-54	210	110	175	90	140		
FDU69-200-54	240	132	200	110	160		
FDU69-250-IP	300	160	250	132	200	H69 (2)	IP20 module or IP54/23 cabinet
FDU69-300-IP	360	200	300	160	240		
FDU69-375-IP	450	250	375	200	300		
FDU69-400-IP	480	250	400	220	320		
FDU69-430-IP	516	300	430	250	344	I69 (3)	
FDU69-500-IP	600	315	500	300	400		
FDU69-595-IP	720	400	600	315	480		
FDU69-650-IP	780	450	650	355	520	J69 (4)	
FDU69-720-IP	864	500	720	400	576		
FDU69-800-IP	960	560	800	450	640	KA69 (5)	
FDU69-995-IP	1200	630	1000	500	800		
FDU69-1K2-IP	1440	800	1200	630	960		
FDU69-1K4-IP	1680	1000	1400	800	1120		
FDU69-1K6-IP	1920	1100	1600	900	1280		
FDU69-1K8-IP	2160	1300	1800	1000	1440		
FDU69-2K0-IP	2400	1400	2000	1100	1600		
FDU69-2K2-IP	2640	1600	2200	1200	1760		
FDU69-2K4-IP	2880	1700	2400	1400	1920		
FDU69-2K6-IP	3120	1900	2600	1500	2080		
FDU69-2K8-IP	3360	2000	2800	1600	2240		
FDU69-3K0-IP	3600	2200	3000	1700	2400		
							K69 (6)
							L69 (7)
						M69 (8)	
						N69 (9)	
						O69 (10)	
						P69 (11)	
						Q69 (12)	
						R69 (13)	
						S69 (14)	
						T69 (15)	

* Available for a limited time and as long as drive temperature permits. Rated data at 40 °C ambient temperature.

** Number in parenthesis, e.g. H69(2), indicates number of parallel power modules.

IP = Available as IP20 module or mounted in IP23 or IP54 cabinet.

Emotron FDU 2.0 - IP54 version

Typical motor power at 3-phase mains voltage 575 V and 690 V (Model 69-250 and up also available as IP20).

FDU Model	Max. output current [A]*	Normal duty (120%, 1 min. every 10 min.)			Heavy duty (150%, 1 min. every 10 min.)			Frame size **	IP class
		Power @ 575V [hp]	Power @ 690V [kW]	Rated current [A]	Power @ 575V [hp]	Power @ 690V [kW]	Rated current [A]		
NEW FDU69-002-54	3.2	1.5	1.5	2	1	0.75	1.6	C69	IP54 wall mounted
NEW FDU69-003-54	4.8	2	2.2	3	1.5	1.5	2.4		
NEW FDU69-004-54	6.4	3	3	4	2	2.2	3.2		
NEW FDU69-006-54	9.6	4	4	6	3	3	4.8		
NEW FDU69-008-54	12.8	5	5.5	8	4	4	6.4		
NEW FDU69-010-54	16	7.5	7.5	10	5	5.5	8		
NEW FDU69-013-54	20.8	10	11	13	7.5	7.5	10.4		
NEW FDU69-018-54	29	15	15	18	10	11	14.4		
NEW FDU69-021-54	34	20	18.5	21	15	15	16.8		
NEW FDU69-025-54	40	25	22	25	20	18.5	20		
NEW FDU69-033-54	53	30	30	33	25	22	26	D69	
NEW FDU69-042-54	67	40	37	42	30	30	34		
NEW FDU69-050-54	80	50	45	50	40	37	40		
NEW FDU69-058-54	93	60	55	58	40	45	46		
NEW FDU69-082-54	98	75	75	82	60	55	66		
FDU69-090-54	108	75	90	90	60	75	72	F69	
FDU69-109-54	131	100	110	109	75	90	87		
FDU69-146-54	175	125	132	146	100	110	117		
FDU69-175-54	210	150	160	175	125	132	140		
FDU69-200-54	240	200	200	200	150	160	160		
FDU69-250-IP	300	250	250	250	200	200	200		H69 (2)
FDU69-300-IP	360	300	315	300	250	250	240		
FDU69-375-IP	450	350	355	375	300	315	300		
FDU69-400-IP	480	400	400	400	300	315	320		
FDU69-430-IP	516	400	450	430	350	315	344	I69 (3)	
FDU69-500-IP	600	500	500	500	400	355	400		
FDU69-595-IP	720	600	600	600	500	450	480		
FDU69-650-IP	780	650	630	650	550	500	520	J69 (4)	
FDU69-720-IP	864	750	710	720	600	560	576		
FDU69-800-IP	960	850	800	800	650	630	640		
FDU69-905-IP	1080	950	900	900	750	710	720	KA69 (5)	
FDU69-995-IP	1200	1000	1000	1000	850	800	800		
FDU69-1K2-IP	1440	1200	1200	1200	1000	900	960	K69 (6)	
FDU69-1K4-IP	1680	1500	1400	1400	1200	1120	1120	L69 (7)	
FDU69-1K6-IP	1920	1700	1600	1600	1300	1250	1280	M69 (8)	
FDU69-1K8-IP	2160	1900	1800	1800	1500	1400	1440	N69 (9)	
FDU69-2K0-IP	2400	2100	2000	2000	1700	1600	1600	O69 (10)	
FDU69-2K2-IP	2640	2300	2200	2200	1800	1700	1760	P69 (11)	
FDU69-2K4-IP	2880	2500	2400	2400	2000	1900	1920	Q69 (12)	
FDU69-2K6-IP	3120	2700	2600	2600	2200	2000	2080	R69 (13)	
FDU69-2K8-IP	3360	3000	2800	2800	2400	2200	2240	S69 (14)	
FDU69-3K0-IP	3600	3200	3000	3000	2500	2400	2400	T69 (15)	

* Available for a limited time and as long as drive temperature permits. Rated data at 40 °C ambient temperature.

** Number in parenthesis, e.g. H69 (2), indicates number of parallel power modules.

IP = Available as IP20 module or mounted in IP23 or IP54 cabinet.

Emotron FDU 2.0 - IP20 version

Typical motor power at 3-phase mains voltage 230 V.

FDU Model	Max. output current [A]*	Normal duty (120%, 1 min every 10 min)			Heavy duty (150%, 1 min every 10 min)			Frame size
		Power @ 230V [kW]	Power @230V [hp]	Rated current [A]	Power @ 230V [kW]	Power @230V [hp]	Rated current [A]	
FDU48-2P5-2Y	3.0	0.37	0.5	2.5	0.25	0.33	2.0	A3
FDU48-3P4-2Y	4.1	0.55	0.75	3.4	0.37	0.5	2.7	
FDU48-4P1-2Y	4.9	0.75	1	4.1	0.55	0.75	3.3	
FDU48-5P6-2Y	6.7	1.1	1.5	5.6	0.75	1	4.5	
FDU48-7P2-2Y	8.6	1.1	1.5	7.2	1.1	1.5	5.8	
FDU48-9P5-2Y	11.4	2.2	3	9.5	1.1	1.5	7.6	
FDU48-012-2Y	14.4	2.2	3	12	2.2	3	9.6	
FDU48-016-2Y	19.2	4.0	5.5	16	2.2	3	12.8	B3
FDU48-023-2Y	27.6	5.5	7.5	23	4.0	5.5	18.4	C3
FDU48-032-2Y	37.2	7.5	10	31	5.5	7.5	24.8	
FDU48-038-2Y	45.6	11	15	38	7.5	10	30.4	
FDU48-025-20	30	5.5	7.5	25	4	5	20	C2
FDU48-030-20	36	7.5	10	30	5.5	7.5	24	
FDU48-036-20	43	7.5	10	36	7.5	10	29	
FDU48-045-20	54	11	15	45	7.5	10	36	
FDU48-058-20	68	15	20	58	11	15	46	
FDU48-072-20	86	18.5	25	72	15	20	58	D2
FDU48-088-20	106	22	30	88	18.5	25	70	
FDU48-105-20	126	30	40	105	22	30	84	
FDU48-142-20	170	37	50	142	30	40	114	E2
FDU48-171-20	205	45	60	171	37	50	137	
FDU48-205-20	246	55	75	205	45	60	164	F2
FDU48-244-20	293	75	100	244	55	75	195	
NEW FDU48-293-20	352	90	125	293	75	100	235	
NEW FDU48-365-20	438	110	150	365	90	125	292	FA2

* Available for a limited time and as long as drive temperature permits. Rated data at 40 °C ambient temperature.



Emotron FDU 2.0 - IP20 version

Typical motor power at 3-phase mains voltage 400 and 460 V.

FDU Model	Max. output current [A]*	Normal duty (120%, 1 min every 10 min)			Heavy duty (150%, 1 min every 10 min)			Frame size
		Power @ 400V [kW]	Power @460V [hp]	Rated current [A]	Power @ 400V [kW]	Power @460V [hp]	Rated current [A]	
FDU48-2P5-2Y	3.0	0.75	1	2.5	0.55	0.75	2.0	A3
FDU48-3P4-2Y	4.1	1.1	1.5	3.4	0.75	1	2.7	
FDU48-4P1-2Y	4.9	1.5	2	4.1	1.1	1.5	3.3	
FDU48-5P6-2Y	6.7	2.2	3	5.6	1.5	2	4.5	
FDU48-7P2-2Y	8.6	3.0	4	7.2	2.2	3	5.8	
FDU48-9P5-2Y	11.4	4.0	5	9.5	3.0	4	7.6	
FDU48-012-2Y	14.4	5.5	7.5	12	4.0	5	9.6	
FDU48-016-2Y	19.2	7.5	10	16	5.5	7.5	12.8	B3
FDU48-023-2Y	27.6	11	15	23	7.5	10	18.4	C3
FDU48-032-2Y	37.2	15	20	31	11	15	24.8	
FDU48-038-2Y	45.6	18.5	25	38	15	20	30.4	
FDU48-025-20	30	11	15	25	7.5	10	20	C2
FDU48-030-20	36	15	20	30	11	15	24	
FDU48-036-20	43	18.5	25	36	15	20	29	
FDU48-045-20	54	22	30	45	18.5	25	36	
FDU48-058-20	68	30	40	58	22	30	46	
FDU48-072-20	86	37	50	72	30	40	58	
FDU48-088-20	106	45	60	88	37	50	70	D2
FDU48-105-20	127	55	75	105	45	60	84	E2
FDU48-142-20	170	75	100	142	55	75	114	
FDU48-171-20	205	90	125	171	75	100	137	
FDU48-205-20	246	110	150	205	90	125	164	F2
FDU48-244-20	293	132	200	244	110	150	195	
FDU48-293-20	352	160	250	293	132	200	235	
FDU48-365-20	438	200	300	365	160	250	292	FA2

* Available for a limited time and as long as drive temperature permits. Rated data at 40 °C ambient temperature.



Emotron FDU 2.0 - IP20 version

Typical motor power at 3-phase mains voltage 575 V and 690 V.

VFX Model	Max. output current [A]*	Normal duty (120%, 1 min. every 10 min.)			Heavy duty (150%, 1 min. every 10 min.)			Frame size
		Power @ 575V [hp]	Power @ 690V [kW]	Rated current [A]	Power @ 575 V [hp]	Power @ 690V [kW]	Rated current [A]	
NEW FDU69-002-20	3.2	1.5	1.5	2	1	0.75	1.6	C2(69)
NEW FDU69-003-20	4.8	2	2.2	3	1.5	1.5	2.4	
NEW FDU69-004-20	6.4	3	3	4	2	2.2	3.2	
NEW FDU69-006-20	9.6	4	4	6	3	3	4.8	
NEW FDU69-008-20	12.8	5	5.5	8	4	4	6.4	
NEW FDU69-010-20	16	7.5	7.5	10	5	5.5	8	
NEW FDU69-013-20	20.8	10	11	13	7.5	7.5	10.4	
NEW FDU69-018-20	29	15	15	18	10	11	14.4	
NEW FDU69-021-20	34	20	18.5	21	15	15	16.8	
NEW FDU69-025-20	40	25	22	25	20	18.5	20	
NEW FDU69-033-20	53	30	30	33	25	22	26	D2(69)
NEW FDU69-042-20	67	40	37	42	30	30	34	
NEW FDU69-050-20	80	50	45	50	40	37	40	
NEW FDU69-058-20	93	60	55	58	40	45	46	

* Available for a limited time and as long as drive temperature permits. Rated data at 40 °C ambient temperature.



General specifications

General specifications for Emotron VFX/FDU 2.0

Mains voltage: *	VFX/FDU48 VFX/FDU52 VFX/FDU69	3-ph, 230-480 V** +10%/-15% (-10% at 230 V) 3-ph, 230-525 V**+10%/-15% 3-ph, 400-690 V** +10%/-15%
Mains frequency		45 to 65 Hz
Input total power factor		0.95 (IP20/21 & IP54), 0.7 - 0.8 (IP2Y)
Output voltage		0-Mains supply voltage:
Output frequency		0-400 Hz
Output switching frequency		3 kHz (48-293/295/365 = 2kHz), FDU adjustable 1.5-6 kHz
Efficiency at nominal load		97% for models 003 to 018 (IP20/21 & IP54) 98% for models 025 to 3K0 (IP20/21 & IP54) 93% for IP2Y frame sizes A3 & B3 95% for IP2Y frame size C3

* Available for both grounded, corner grounded, and isolated supply (TN and IT nets).

**Nominal voltage selected with parameter.

Environmental conditions

Parameter	Normal operation
Nominal ambient temperature	0°C - 40°C (32°F - 104°F). For size C69/D69/C2(69)/D2(69): 0°C - 45°C (32°F - 113°F). With derating max 50/55 °C
Atmospheric pressure	86-106 kPa (12.5 - 15.4 PSI)
Relative humidity according to IEC 60721-3-3	Class 3K4, 5...95% and no condensing
Contamination, according to IEC 60721-3-3	No electrically conductive dust allowed. Cooling air must be clean and free from corrosive materials. Chemical gases, class 3C2 (coated boards 3C3). Solid particles, class 3S2.
Vibrations	According to IEC 60068-2-6, Sinusoidal vibrations: 10<f<57 Hz, 0.075 mm (0.00295 ft) 57<f<150 Hz, 1g (0,035 oz) Frame sizes B to D2: IEC 60721-3-3 3M4 (2 - 9 Hz, 3.0mm and 9 - 20Hz, acc. 1g (10m/s ²))
Altitude	0-1000 m (0 - 3280 ft) 480V AC drives, with derating 1%/100 m (328 ft) of rated current up to 4000 m (13123 ft) 690V AC drives, with derating 1%/100 m (328 ft) of rated current up to 2000 m (6562) ft Coated boards required for 2000 - 4000 m(6562 - 13123 ft).

Parameter	Storage condition
Temperature	-20 to +60 °C (-4 to + 140 °F)
Atmospheric pressure	86-106 kPa (12.5 - 15.4 PSI)
Relative humidity according to IEC 60721-3-1	Class 1K4, max. 95% and no condensing and no formation of ice.



VFX/FDU48:
Model 430 - 500 (H)

VFX/FDU69:
Model 250 - 400 (H69)



VFX/FDU48:
Model 600 - 750 (I)

VFX/FDU69:
Model 430 - 595 (I69)

Standards

Market	Standard	Description
European	EMC Directive	2014/30/EU
	Low Voltage Directive	2014/35/EU
	WEEE Directive	2012/19/EU
All	EN 60204-1	Safety of machinery - Electrical equipment of machines Part 1: General requirements.
	EN(IEC)61800-3:2004	Adjustable speed electrical power drive systems Part 3: EMC requirements and specific test methods. EMC Directive: Declaration of Conformity and CE marking
	EN(IEC)61800-5-1 Ed. 2.0	Adjustable speed electrical power drive systems Part 5-1. Safety requirements - Electrical, thermal and energy. Low Voltage Directive: Declaration of Conformity and CE marking
	IEC 60721-3-3	Classification of environmental conditions. Air quality chemical vapours, unit in operation. Chemical gases 3C2, Solid particles 3S2. Optional with coated boards Unit in operation. Chemical gases Class 3C3, Solid particles 3S2.
North & South America	UL508C	UL Safety standard for Power Conversion Equipment
	USL	USL (United States Standards - Listed) complying with the requirements of UL508C Power Conversion Equipment
	UL 840	UL Safety standard for Power Conversion Equipment. Insulation coordination including clearances and creepage distances for electrical equipment.
	CNL	CNL (Canadian National Standards - Listed) complying with the requirements of CAN/CSA C22.2 No. 14-10 Industrial Control Equipment.
Russian	EAC (former GOST R)	For all sizes.

Operation at higher temperatures

Emotron AC drives are designed for nominal operation at maximum of 40°C ambient temperature.

Frame size C69/D69/C2(69)/D2(69) rated at max 45°C.

However, for most models, it is possible to use the AC drive at higher temperatures with reduced output rating (derating).

Possible derating

Derating of output current is possible with

-1% / degree Celsius to max +10 °C (max 50 °C for IP2Y)

-1% / degree Celsius to max +15 °C (max 55 °C for IP54 and IP20/21)

-0.55% / degree Fahrenheit to max +18 °F (max 122 °F for IP2Y)

-0.55% / degree Fahrenheit to max +27 °F (max 131 °F for IP54 and IP20/21)

Dimensions, weights and cooling air flow

The tables below give an overview of the dimensions, weights, and the required air flow for cabinet mounting of the modules.

Drives with model numbers up to 48-365 are available as wall mounted modules; with the choice of an IP54 version (frame size B to FA), and an IP20/21 version (frame size C2 to FA2) that is also optimized for cabinet mounting.

Models from 48-430/69-250 and up consist of 2 to 15 paralleled power electronic building blocks (PEBBs), which can be delivered in standard IP23 or IP54 cabinets, or be cabinet/panel mounted as a conformity to IP20.

Mechanical specifications for models VFX/FDU48/69 - IP2Y/ and - IP20/21 version

Models	Frame size	Dim. H1/H2 x W x D mm (in) IP20*	Dim. H1/H3 x W x D mm (in) IP21**	Weight kg (Lbs) IP20/IP21	Air flow m3/hour
48-2P5-2Y to -012-2Y	A3	220/287 x 120 x 169 (8.7/11.3 x 4.7 x 6.7)	-	2.6 (5.7)	39
48-016-2Y to -023-2Y	B3	255/325 x 145 x 179 (9.8/12.8 x 5.7 x 7)	-	3.9 (8.6)	89
48-032-2Y to -038-2Y	C3	335/407 x 190 x 187 (13.2/16 x 7.5 x 7.4)	-	5 (11)	177
48-025 to 48-030 / 69-002 to 69-013	C2/C2(69)	446 / 536 x 176 x 267 (17.2/21.1 x 6.9 x 10.5)	438 / 559 x 196 x 282 (17.2/22 x 7.7 x 11.1)	17 (37.5)	120
48-036 to 48-058 / 69-018 to 69-025					170
48-060 to 48-105 / 69-033 to 69-058	D2/D2(69)	545 / 658 x 220 x 291 (21.5/25.9 x 8.7 x 11.5)	545 / 670 x 240 x 307 (21.5/26.4 x 9.5 x 12.1)	30 (66)	170
48-106 to 48-171	E2	956 / 956 x 275 x 294 (37.6/37.6 x 10.8 x 11.6)	956 / 956 x 275 x 323 (37.6/37.6 x 10.8 x 12.7)	53 (117)	510
48-205 to 48-293	F2	956 / 956 x 335 x 294 (37.6/37.6 x 13.2 x 11.6)	956 / 956 x 335 x 323 (37.6/37.6 x 13.2 x 12.7)	69 (152)	800
48-365	FA2	1090/ 1250 x 335 x 306 (42.9/49.5 x 13.2 x 12.1)		84 (185)	1020

H1 = Enclosure height H2 = Total height including cable interface H3 = Total height including top cover * without top cover ** with top cover

IP2Y and IP20/21 version of Emotron VFX 2.0 and FDU 2.0



Mechanical specifications for models VFX/FDU48 and VFX/FDU52 - IP54 version

Models (48- or 52-)	Frame size	IP20/21 Dim. H x W x D mm (mm)	IP54 Dim. H x W x D mm (in)	IP20/21 Weight kg (lb)	IP54 Weight kg (lb)	Air flow m3/hour
003 to 018	B	n/a	350/416 x 203 x 203 (13.8/16.4 x 8 x 7.9)	-	12.5 (27.6)	75
026 to 031	C	n/a	440/512 x 178 x 292 (17.3/20.2 x 7 x 11.5)	-	24 (52.9)	120
037 to 046						170
061 to 074	D	n/a	545/590 x 220 x 295 (21.5/23.2 x 8.7 x 11.5)	-	32 (70.6)	170
090 to 109	E	n/a	950 x 285 x 314 (37.4 x 11.2 x 12.4)	-	56 (123.5)	510
146 to 175						
210 to 295	F	n/a	950 x 345 x 314 (37.4 x 13.6 x 12.4)	-	75 (165.4)	800
365	FA	n/a	1395 x 345 x 365 (54.9 x 13.6 x 14.4)	-	95 (209)	1020
430 to 500	H (2xF)	1036 x 500 x 450 (40.8 x 19.7 x 17.7)	2250 x 600 x 600 (88.6 x 23.6 x 23.6)	170 (374.8)	380 (837.8)	1600
600 to 750	I (3xF)	1036 x 730 x 450 (40.8 x 28.7 x 17.7)	2250 x 900 x 600 (88.6 x 35.4 x 23.6)	248 (546.7)	506 (1116)	2400
860 to 1K0	J (2xH)	1036 x 1100 x 450 (40.8 x 43.3 x 17.7)	2250 x 1200 x 600 (88.6 x 47.2 x 23.6)	340 (749.6)	697 (1537)	3200
1K15 to 1K25	KA (H+I)	1036 x 1365 x 450 (40.8 x 53.7 x 17.7)	2250 x 1500 x 600 (88.6 x 59.1 x 23.6)	418 (921.5)	838 (1847)	4000
1K35 to 1K5	K (2xI)	1036 x 1630 x 450 (40.8 x 64.2 x 17.7)	2250 x 1800 x 600 (88.6 x 70.9 x 23.6)	496 (1093)	987 (2176)	4800
1K75	L (2xH+I)	1036 x 2000 x 450 (40.8 x 78.7 x 17.7)	2250 x 2100 x 600 (88.6 x 82.7 x 23.6)	588 (1296)	1190 (2624)	5600
2K0	M (H+2xI)	1036 x 2230 x 450 (40.8 x 87.8 x 17.7)	2250 x 2400 x 600 (88.6 x 94.5 x 23.6)	666 (1468)	1323 (2917)	6400
2K25	N (3xI)	1036 x 2530 x 450 (40.8 x 99.6 x 17.7)	2250 x 2700 x 600 (88.6 x 106.3 x 23.6)	744 (1640)	1518 (3347)	7200
2K5	O (2xH+2xI)	1036 x 2830 x 450 (40.8 x 111.4 x 17.7)	2250 x 3000 x 600 (88.6 x 118.1 x 23.6)	836 (1834)	1772 (3907)	8000

1) IP20 module for cabinet mounting.
n/a = not applicable



VFX/FDU48/52: Model 003 - 018 (B)

VFX/FDU48/52: Model 026 - 046 (C)

VFX/FDU48/52: Model 061 - 074 (D)

Mechanical specifications for models VFX/FDU69 - IP54 version

Models (69-)	Frame size	IP20/21 Dim. H x W x D mm (mm)	IP54 Dim. H x W x D mm (in)	IP20/21 Weight kg (lb)	IP54 Weight kg (lb)	Air flow m3/hour
002 to 025	C69	–	440/512 x 178 x 314 (17.3/20.2 x 7.0 x 12.3)	–	19.8 (43.6)	170
033 to 058	D69	–	545/590 x 220 x 295 (21.5/23.2 x 8.7 x 11.6)	–	32 (70.5)	170
082 to 200	F69	–	1090 x 345 x 314 (42.9 x 13.6 x 12.4)	–	77 (169.8)	800
250 to 400	H69 (2xF69)	1176 x 500 x 450 (46.3 x 19.7 x 17.7)	2250 x 600 x 600 (88.6 x 23.6 x 23.6)	176 (388)	399 (879.6)	1600
430 to 595	I69 (3xF69)	1176 x 730 x 450 (46.3 x 28.7 x 17.7)	2250 x 900 x 600 (88.6 x 35.4 x 23.6)	257 (566.6)	563 (1241)	2400
650 to 800	J69 (2xH69)	1176 x 1100 x 450 (46.3 x 43.3 x 17.7)	2250 x 1200 x 600 (88.6 x 47.2 x 23.6)	352 (776)	773 (1704)	3200
905 to 995	KA69 (H69+I69)	1176 x 1365 x 450 (46.3 x 53.7 x 17.7)	2250 x 1500 x 600 (88.6 x 59.1 x 23.6)	433 (954.6)	937 (2066)	4000
1K2	K69 (2xI69)	1176 x 1630 x 450 (46.3 x 64.2 x 17.7)	2250 x 1800 x 600 (88.6 x 70.9 x 23.6)	514 (1133)	1100 (2425)	4800
1K4	L69 (2xH69+I69)	1176 x 2000 x 450 (46.3 x 78.7 x 17.7)	2250 x 2100 x 600 (88.6 x 82.7 x 23.6)	609 (1343)	1311 (2890)	5600
1K6	M69 (H69+2xI69)	1176 x 2230 x 450 (46.3 x 87.8 x 17.7)	2250 x 2400 x 600 (88.6 x 94.5 x 23.6)	690 (1521)	1481 (3265)	6400
1K8	N69 (3xI69)	1176 x 2530 x 450 (46.3 x 99.6 x 17.7)	2250 x 2700 x 600 (88.6 x 106.3 x 23.6)	771 (1700)	1651 (3640)	7200
2K0	O69 (2xH69+2xI69)	1176 x 2830 x 450 (46.3 x 111.4 x 17.7)	2250 x 3000 x 600 (88.6 x 118.1 x 23.6)	866 (1909)	1849 (4076)	8000
2K2	P69 (H69+3xI69)	1176 x 3130 x 450 (46.3 x 123.2 x 17.7)	2250 x 3300 x 600 (88.6 x 129.9 x 23.6)	947 (2088)	2050 (4519)	8800
2K4	Q69 (4xI69)	1176 x 3430 x 450 (46.3 x 135 x 17.7)	2250 x 3600 x 600 (88.6 x 141.7 x 23.6)	1028 (2266)	2214 (4881)	9600
2K6	R69 (2xH69+3xI69)	1176 x 3730 x 450 (46.3 x 146.9 x 17.7)	2250 x 3900 x 600 (88.6 x 153.5 x 23.6)	1123 (2476)	2423 (5342)	10400
2K8	S69 (H69+4xI69)	1176 x 4030 x 450 (46.3 x 158.7 x 17.7)	2250 x 4200 x 600 (88.6 x 165.4 x 23.6)	1204 (2654)	2613 (5761)	11200
3K0	T69 (5xI69)	1176 x 4330 x 450 (46.3 x 170.5 x 17.7)	2250 x 4500 x 600 (88.6 x 177.2 x 23.6)	1285 (2833)	2777 (6122)	12000

1) IP20 module for cabinet mounting.
n/a = not applicable



VFX/FDU48: Model 090 - 175 (E)



VFX/FDU48: Model 210 - 295 (F)
VFX/FDU69: Model 082 - 200 (F69)



VFX/FDU48: Model 430 - 500 (H) IP20 module

Control performance for Emotron VFX 2.0 (Speed)

Speed control static accuracy (linearity):

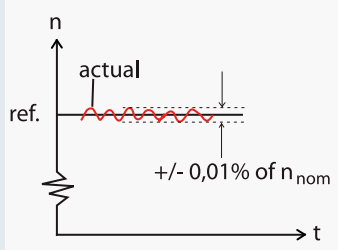

Closed loop = 0.01% of n_{nom}
Open loop = 0.1% of n_{nom}

Control performance for Emotron VFX 2.0 (Torque)

Torque control static accuracy (linearity):

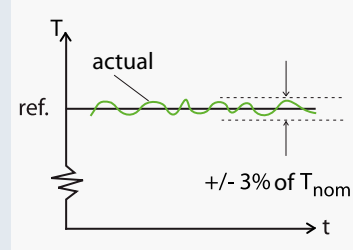

Closed loop: <3% of T_{nom}
Open loop: <3% for speeds 10 - 100% of rated, and <10% at zero speed (% of n_{nom}).

Speed Control dynamic accuracy (impact drop):

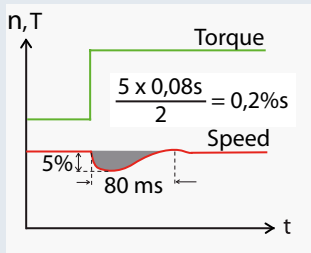

Closed loop = 0.2%sec (100% load step)
Open loop = 0.4%sec (100% load step)

Torque control dynamic accuracy:

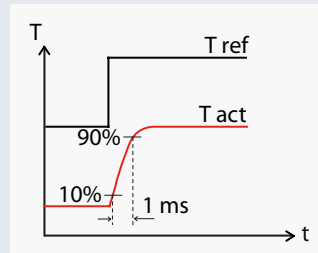

Closed and open loop:
100% torque step rise time = 1 ms.

Control performance for Emotron FDU 2.0 (V/Hz)

Speed control accuracy = approximately 1% of n_{nom} (slip frequency).

Torque accuracy = approximately 5% of T_{nom} (20 - 100% speed).

Basic I/O data

Control signal inputs: Analogue (differential), 4 channels	
Analogue voltage/current Max. input voltage Input impedance	0-±10 V/0-20 mA via switch +30 V 20 kΩ (voltage) 250 Ω (current)
Resolution Hardware accuracy Non-linearity	11 bits + sign 0.5% type + 1 ½ LSB fsd 1½ LSB
Digital: 8 channels	
Input voltage Max. input voltage Input impedance Signal delay	High > 9 V _{DC} Low < 4 V _{DC} +30 V _{DC} < 3.3 V _{DC} : 4.7 kΩ, ≥ 3.3 V _{DC} : 3.6 kΩ ≤ 8 ms
Control signal outputs: Analogue, 2 channels	
Output voltage/current Max. output voltage Short-circuit current (∞) Output impedance Resolution Maximum load impedance for current Hardware accuracy Offset Non-linearity	0-10 V/0-20 mA via software setting +15 V @ 5 mA cont. +15 mA (voltage) + 140 mA (current) 10 Ω (voltage) 10 bit 500 Ω 1.9% type fsd (voltage), 2.4% type fsd (current) 3 LSB 2 LSB
Digital, 2 channels	
Output voltage Short-circuit current (∞)	High > 20 V _{DC} @ 50 mA, > 23 VDC open Low < 1 V _{DC} @ 50 mA 100 mA max (together with +24 V _{DC})
Relays, 3 pcs	
Contacts	0.1 – 2 A/Umax 250 VAC or 42 V _{DC}
Reference voltages	
+10 V _{DC} -10 V _{DC} +24 V _{DC}	+10 V _{DC} @ 10 mA short-circuit current + 30 mA max -10 V _{DC} @ 10 mA +24 V _{DC} short-circuit current + 100 mA max (together with Digital Outputs)

See "User interface data" on page 26 for connection data and default settings



User interface data

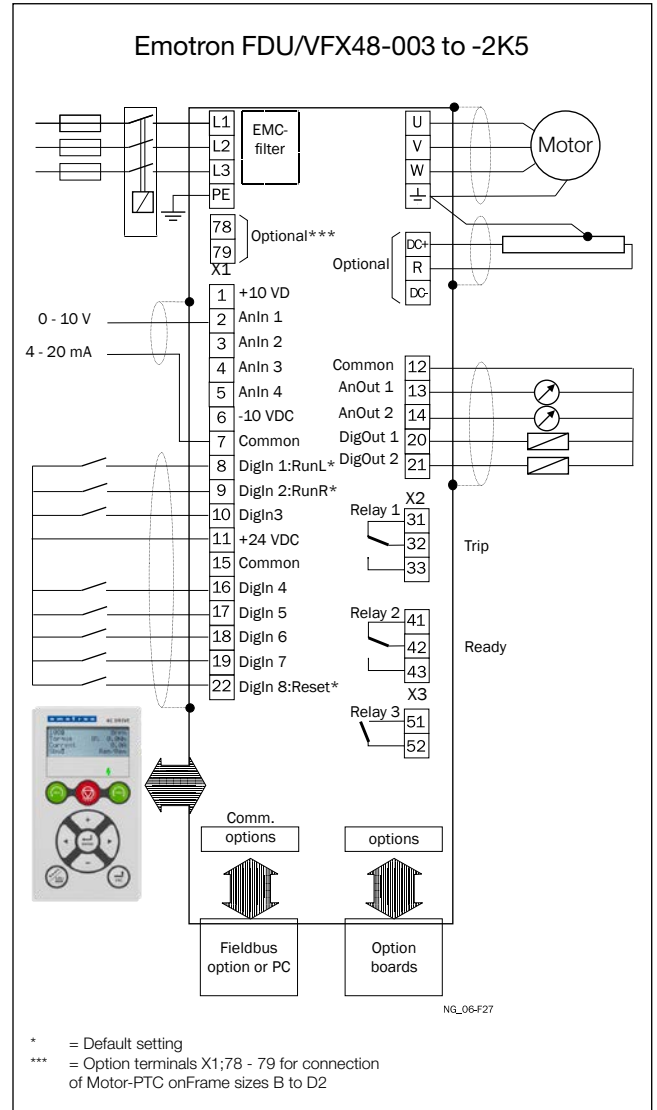
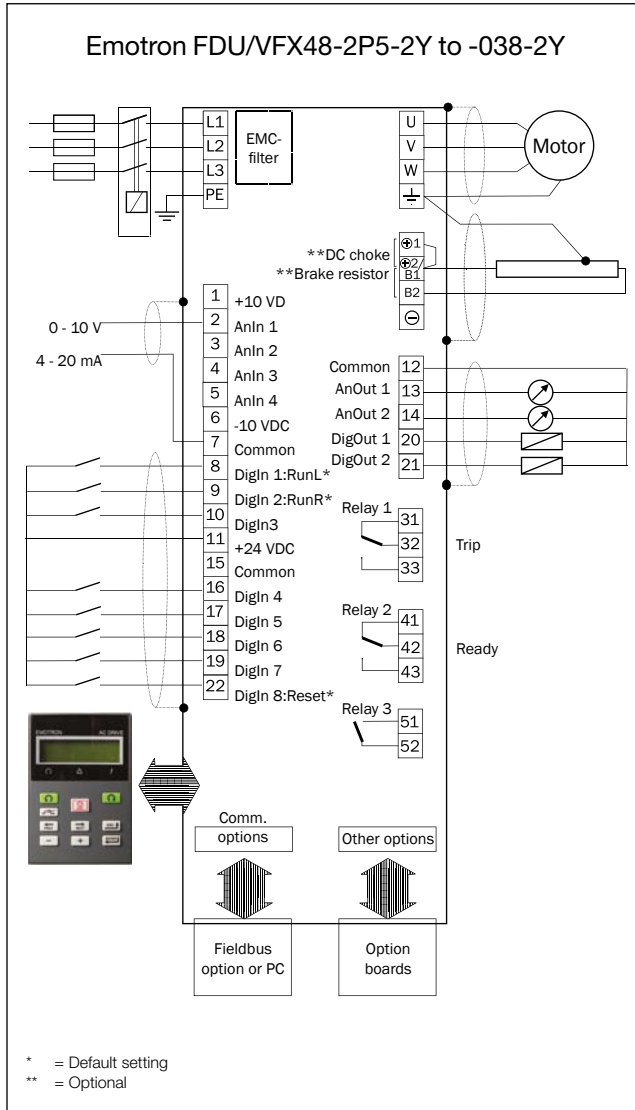

X1	Name:	Function (Default):
1	+10 V	+10 VDC Supply voltage
2	AnIn1	Speed reference
3	AnIn2	Not used
4	AnIn3	Not used
5	AnIn4	Not used
6	-10 V	-10VDC Supply voltage
7	Common	Signal ground
8	DigIn 1	RunL
9	DigIn 2	RunR
10	DigIn 3	Not used
11	+24 V	+24VDC Supply voltage
12	Common	Signal ground
13	AnOut 1	Min speed to max speed
14	AnOut 2	0 to max torque
15	Common	Signal ground
16	DigIn 4	Not used
17	DigIn 5	Not used
18	DigIn 6	Not used
19	DigIn 7	Not used

X1	Name:	Function (Default):
20	DigOut 1	Ready
21	DigOut 2	Brake/No trip
22	DigIn 8	Reset

X2	Name:	Function (Default):
31	N/C 1	Relay 1 output=Trip Active when the AC drive is in a TRIP condition. N/C is opened when the relay is active (valid for all relays) N/O is closed when the relay is active (valid for all relays)
32	COM 1	
33	N/O 1	
41	N/C 2	Relay 2 Output=Ready Active when the AC drive is ready to start
42	COM 2	
43	N/O 2	

X3	Name:	Function (Default):
51	COM 3	Relay 3 Output=Not used
52	N/O 3	

All inputs and outputs are programmable.

Standard options

For Emotron VFX/FDU 2.0

STANDARD OPTION	IP2Y		IP20/21 and IP54/20	
	Frame sizes A3 - C3		Frame sizes C2 - FA2 and C69 - F69/C2(69) - F2(69)	
	All boards are coated. Support for 2 option boards and 1 communication option		All boards are coated. Support for 3 option boards and one communication option	
	Part no.	Remark	Part no.	Remark
I/O board	01-6070-01		01-3876-01	
Encoder board	01-6070-03		01-3876-03	Max 1 Encoder board
PTC/PT100 board	Not available		01-3876-08	Max 2 PTC/PT100 board
PTC board	01-6070-08		Not available	
RS232/485	01-6070-07		01-3876-04	
Standby power supply	01-6070-00		Available as factory built in option	
Safe stop	01-6070-02		Available as factory built in option IP54 (IP2x:see price list)	
CRIO board	Not available		01-3876-07	Only for VFX
Crane interface	Not available		590059	230 V _{AC} Only for VFX
			590060	24 V _{DC} Only for VFX
Fieldbus - Profibus	01-6070-05		01-3876-05	
Fieldbus - DeviceNet	01-6070-06		01-3876-06	
NEW Fieldbus - CANopen	01-6070-16		01-3876-16	
Ethernet - Modbus TCP	01-6070-09		01-3876-09	
Ethernet - Modbus/TCP M12	01-6070-14		01-3876-14	
Ethernet - EtherCAT®	01-6070-10		01-3876-10	
Ethernet - Profinet IO 1-port	01-6070-11		01-3876-11	
Ethernet - Profinet IO 2-port	01-6070-12		01-3876-12	
Ethernet - EtherNet IP 2-port	01-6070-13		01-3876-13	

I/O board



3 extra relay outputs (230 VAC/5 A NO/NC). 3 extra 24 V /3.2 kΩ (AC or DC) differential digital inputs, all programmable. Inputs providing 50 VAC/DC isolation between channels. Maximum 3 I/O boards can be built -in per AC drive.

Encoder board



Differential encoder input suitable for 5 V (TTL) or 24 V (HTL) incremental encoders, range 5-16384 pulses/revolution. Inputs min 9 kΩ. Max frequency = 100 kHz. For single ended or differential type of encoders (A/B, A'/B'). Selectable encoder supply voltage output 5 VDC or 24 VDC.

PTC/PT100 board



1 PTC isolated input conforming DIN 44081/44082. Max 6 PTC thermistors can be connected in series to PTC input. Also including 3 PT100 inputs, 2/3/4-wire, conforming EN 60751.

PTC board



1 PTC isolated input conforming DIN 44081/44082. Max 6 PTC thermistors can be connected in series to PTC input.

CRIO board (VFX)



Crane option board to control hoist or travel motions. Inputs for joystick control: supporting 4-step, motor potentiometer or analog reference joystick types. Inputs for slow down and end limits switches (2+2).

All 12 digital inputs 24 V/5 kΩ (8 - 24V) DC. 2 relay outputs 250 V/2AAC, for mechanical brake and load deviation protection. Load dependent field weakening operation of hoists also supported.

Crane interface (VFX)



Isolated I/O interface for control signals between (existing) crane controls and crane option board (CRIO).

- Available for 230 V/27 kΩ (120 - 250V) AC
- 24 V /2.7 kΩ (15 - 36 V) DC input signals.
- LED indications for all inputs and outputs.
- For DIN-rail mounting.
- HxWxD = 125 x 150 x 50 mm

RS232/RS485 isolated



Isolated RS232/RS485 serial communication board. For Modbus/RTU communication protocol. Baud rates: 2400 - 38400 bits/s supported.

Standard options for Emotron VFX/FDU 2.0

Fieldbus and Ethernet boards

Typical drive response time = 10 ms (not including any ethernet delays).



Fieldbus - Profibus

Fieldbus option module for Profibus DP or DP V1 communication. Use 9-pin D-sub connector. Baud rates: 9.6 kbits/s - 12 Mbits/s supported.

Fieldbus - DeviceNet

Fieldbus option module for DeviceNet communication. Baud rates: 125 - 500 kbits/s supported.

Ethernet - Modbus/TCP

Industrial Ethernet option module for Modbus/TCP protocol. RJ45 type connector. Baud rates: 10 or 100 Mbits/s supported.

Ethernet - Modbus/TCP M12

Industrial Ethernet option module for Modbus/TCP protocol. M12 type connectors, 2-port. Baud rates: 10 or 100 Mbits/s supported.

Ethernet - Profinet IO 1-port

Industrial Ethernet option module for Profinet IO (RT) protocol. RJ45 type connector. Baud rate: 100 Mbits/s

Ethernet - Profinet IO 2-port

Industrial Ethernet option module for Profinet IO (RT) protocol. 2 x RJ45 type connectors. Baud rate: 100 Mbits/s

Ethernet - EtherCAT®

Industrial Ethernet option module for EtherCAT protocol. 2 x RJ45 type connectors (IN and OUT). Baud rate: 100 Mbits/s

Ethernet - EtherNet IP 2-port

Industrial Ethernet option module for EtherNet IP protocol. 2 x RJ45 type connector. Baud rate: 100 Mbits/s

Fieldbus - CANopen **NEW**

Fieldbus option module for CANopen communication. CANopen certified, compliant with profile DS301 V4.02. Use 9-pin D-sub connector. Baud rates 10 kbit/s - 1 Mbits/s

Control panel kit, incl. blank panel



External control panel IP54 suitable for mounting on a cabinet door. This option is to be used in combination with an AC drive module ordered with a built-in control panel.

Part no.

01-6878-40 (Size B)

01-6879-40 (Size C)

01-6880-40 (Size D and up)

01-7211-00 (IP2X units. Without PPU)

Control panel kit, incl. control panel



External control panel IP54 suitable for mounting on a panel door. This option is to be used in combination with an AC drive module ordered with a blank control panel.

Part no.

01-6878-00 Std PPU (Size B)

01-6878-10 PPU w Bluetooth (Size B)

01-6879-00 Std PPU (Size C)

01-6879-10 PPU w Bluetooth (Size C)

01-6880-00 Std PPU (Size D and up)

01-6880-10 PPU w Bluetooth (Size D and up)

Handheld Control Panel HCP 2.0



Handheld control panel with full functionality. Easy to connect to the AC drive for temporary use during e.g. commissioning and service. The HCP 2.0 enables setting of parameters and viewing of actual values and fault logger. It also offers the possibility to copy parameter data from one AC drive to other AC drives. Part no. 01-5039-30 (complete with cable)

Standard options for Emotron VFX/FDU 2.0

Standby power supply



Standby power supply board for AC drive type IP2Y, frame sizes A3, B3 and C3
To be connected to external 24 V AC/DC supply voltage. If the main power is switched off, the control board, control panel and the connected options, for example fieldbus communication, will continue to operate.

Safe stop



Safe stop (STO) board for AC drive type IP2Y, frame sizes A3, B3 and C3
Extra built-in inputs and outputs for emergency stop circuit (Safe Torque Off), conforming with the norms EN-IEC 62061:2005 SIL2 and EN-ISO 13849-1:2006.

Control panel with Bluetooth comm. **NEW**



New 4-line PPU with Bluetooth communication, used with "Emo PPU" App (for iPhone and Android phones).

EmoSoftCom

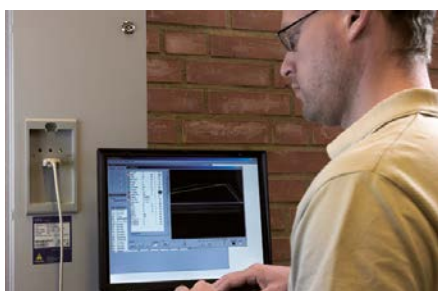

Connect a PC with a standard RS232 cable under the control panel on the front. EmoSoftCom PC software makes it possible to perform signal recordings and save/load parameter backup data, for example during service & maintenance.

Glands for IP54 frame sizes B, C and D



Gland kits are available for size B, C, and D. Metal EMC glands are used for motor and brake resistor cables.

Part No	Current	Frame size
01-4601-21	3 - 6A (M16 - M20)	B
01-4601-22	8 - 10A (M16 - M25)	
01-4601-23	13 - 18A (M16 - M32)	
01-4399-01	26 - 31A (M12 - M32)	C
01-4399-00	37 - 46A (M12 - M40)	
01-4833-00	61 - 74A (M20 - M50)	D

Coated boards

All drive boards are also available as coated, recommended e.g. for sewer pump applications (Hydrogen sulphide gases) or installations with occasional high humidity (if machine room installation or tropical climate). IEC60721-3-3 gases class 3C3, solid particles class 3S2

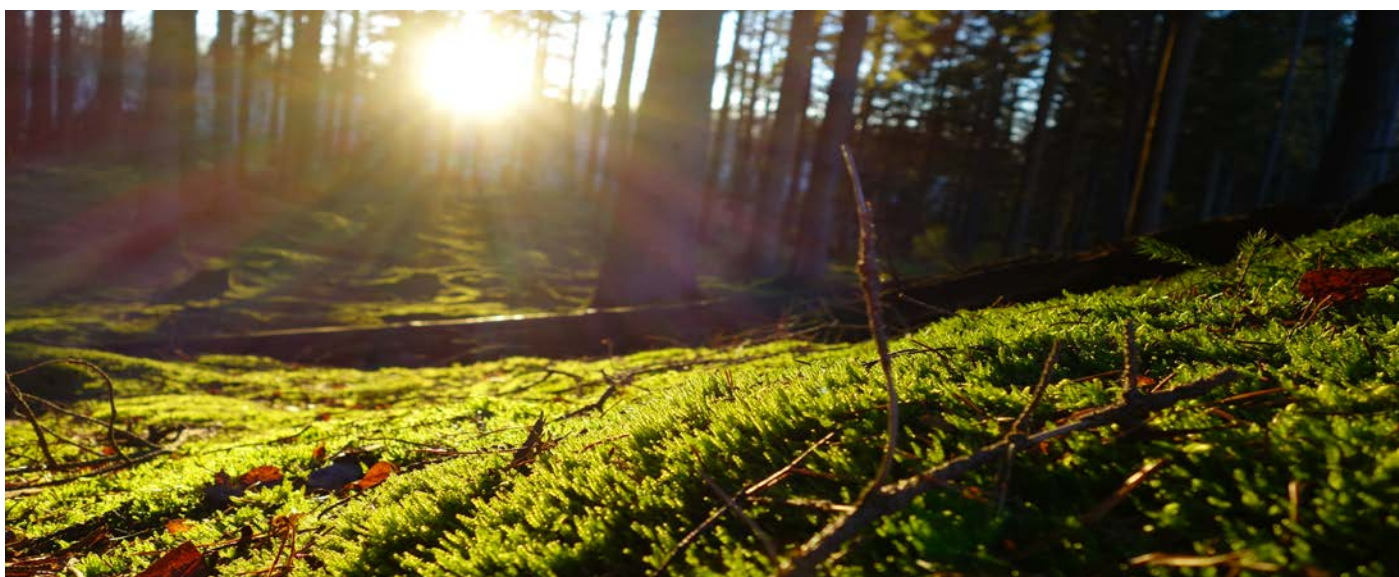

Factory mounted options for Emotron VFX/FDU 2.0

Standby power supply



Built-in standby power supply board.
To be connected to external 24 V AC/DC supply voltage. If the main power is switched off, the control board, control panel and the connected options, for example fieldbus communication, will continue to operate.
Part no: 01-3954-00
Part no: 01-3954-50 (coated)

Blank control panel



Blank panel instead of control panel (to maintain IP54). Indication LED's for Power, Run and Trip available.

Safe stop



*Safe stop for size B to D2
(uses 1 of the 3 option positions)*



Safe stop for size E, E2 and up

Extra built-in inputs and outputs for emergency stop circuit (Safe Torque Off), conforming with the norms EN-IEC 62061:2005 SIL2 and EN-ISO 13849-1:2006.

EMC filter class C2

EMC filter according to EN61800-3:2004 class C2 - 1st environment restricted distribution. For sizes B to D2. Integrated inside the drive module.

Note: EMC filter according to class C3 - 2nd environment included as standard in all drive units.

Brake chopper

All Emotron VFX/FDU drives can be fitted with an optional built-in brake chopper (standard in IP2Y).

Brake choppers are rated for continuous braking at drive rated load (IP20/21 & IP54).

This option can not be after mounted. The brake resistor must be mounted outside the AC drive. (See page 28 for Brake resistor option).

DC+ /DC- connection

DC+/DC- terminals for external connection of the Emotron VFX/FDU drive DC link. This option is required if using the Overshoot clamp.



PTC

Factory mounted, isolated motor PTC input conforming to DIN44081/44082.

Available with size B to D2. Use PTC/PT100 option board if additional inputs are needed.



Extended options for Emotron VFX/FDU 2.0

Extended EMC filter 90-650A



EMC filter according to EN61800-3:2004 class C2 - 1st environment, restricted distribution. From frame size E. Rated voltage=480 V, 50/60 Hz. Max. 40 °C ambient temperature.

Drive model	Filter type	Dimensions HxWxD [mm]	Weight [kg]	Enclosure
VFX/FDU48-090	3F480-100.230	325x150x107	7.1	IP20 ¹
VFX/FDU48-109	3F480-125.230	345x175x127	10	IP20 ¹
VFX/FDU48-146	3F480-150.230	375x175x135	10	IP20 ¹
VFX/FDU48-175	3F480-180.230	490x170x158	13.5	IP00 ²
VFX/FDU48-210	3F480-220.230	490x170x158	13.5	IP00 ²
VFX/FDU48-250	3F480-250.230	490x230x158	18.2	IP00 ²
VFX/FDU48-300	3F480300.230	490x230x158	18.2	IP00 ²
VFX/FDU48-375	3F480-400.230	580x230x158	22	IP00 ²
VFX/FDU48-430	3F480-500.230	630x345x158	37.5	IP00 ²
VFX/FDU48-500	3F480-500.230	630x345x158	37.5	IP00 ²
VFX/FDU48-600	3F480-600.230	660x375x187	42	IP00 ²
VFX/FDU48-650	3F480-700.230	865x345x157	42	IP00 ²

1=Screw terminal (protected)

2=Busbar terminals

Output choke (dU/dt)

Output chokes (supplied separately) are recommended above app. 100 m cable length for all single drives. Consult your supplier in case of paralleled drives. Due to the switching of output voltage, high capacitive peak currents will run through the parasitic capacitances between the phases and to earth. Screened cables have more parasitic capacitances. Output chokes should be installed as close as possible to the drive output. Output chokes also limits voltage peaks at motor winding.

Rated voltage = 800 V, IP00 units. Suitable for up to IP23 cabinet installation.

Max. 40°C ambient temperature.

Parallel connection of output coils possible if higher current rating required (e.g. one filter per PEBB).



Nominal current (I_N) A/Phase	L [mH]	Weight [kg]	Dimensions HxWxD [mm]	Part no.
2.8	1.5	0.6	60x78x95	473160 00
4.4	1	0.6	60x78x95	473161 00
6.6	0.65	0.6	60x78x95	473162 00
11	0.4	1	65x96x105	473163 00
14.3	0.3	1	65x96x105	473164 00
18.2	0.25	1.2	74x96x105	473165 00
26.4	0.175	1.2	74x96x105	473166 00
32	0.15	1.7	84x125x140	473167 00
65	0.1	4	105x155x205	473168 00
90	0.1	8.4	120x90x235	473169 00
146	0.05	10.2	140x190x260	473170 00
175	0.05	13.4	160x210x180	473171 00
275	0.032	18.4	170x230x200	473172 00
275 (flat mounting)	0.032	18.4	193x254x162	74052065L2
320	0.025	18.9	170x230x200	473173 00
410	0.021	22.6	180x240x210	473174 00

Overshoot clamp

Together with the output choke, the overshoot clamp limits the voltage to the motor.

For rated voltages 380 - 690 V.

H x W x D = 250 x 145 x 95 mm

Part no.

052163 (size B-F/F2/F69)

052220 (size G and up)



Sine wave filter



Only for use with FDU drives. Rated voltage= 400 V \pm 25%, 50/60 Hz (690 V on request). Max. 40°C ambient temperature. IP20= with enclosure and screw terminals. IP00=no enclosure and busbar connections.

Voltage drop approximately 25 V at rated current, 50 Hz.

Overload: 110% for 5 min, 150% for 2 min or 200% for 30 s. For further information see filter selection guide, page 31

Filter type 3AFS400-	Protection class	Power [kW]	Nom. current (I _N) A/Phase	Power loss [W]	Weight [kg]	Dimensions HxWxD [mm]
002.5	IP20	0.75	2.5	75	5	190x165x160
004	IP20	1.5	4	90	5	190x165x160
007	IP20	2.2	7	125	7	250x162x162
010	IP20	4	10	165	9	250x162x162
013	IP20	5.5	13	190	12	250x162x162
016	IP20	7.5	16	220	13	300x210x180
025	IP20	11	25	250	18	300x250x210
035	IP20	15	35	275	25	300x270x235
010	IP00	4	10	165	9	195x200x115
013	IP00	5.5	13	190	12	225x200x115
016	IP00	7.5	16	220	13	225x240x135
025	IP00	11	25	250	18	270x250x160
035	IP00	15	35	275	25	270x250x160
050	IP00	22	50	320	45	280x300x250
063	IP00	30	63	550	49	270x300x370
080	IP00	37	80	380	65	324x360x320
100	IP00	45	100	530	65	324x360x320
125	IP00	55	125	650	85	335x390x320
150	IP00	75	150	580	119	440x480x340
180	IP00	90	180	760	131	440x480x340
250	IP00	132	250	600	135	420x420x390
300	IP00	160	300	1000	140	420x420x390
400	IP00	200	400	1100	320	440x500x400
500	IP00	250	500	1250	335	470x500x400

Common mode filter

Common mode filters are mainly used to reduce common mode currents in motors (typically used with motors >size 280). Common mode filters can prevent damage of motor bearings.

All three motor phases (without shield) are to be routed through common mode filter rings.

These filters can also be used to reduce EMC emissions in supply cables.

Di = 35mm, Dy = 59mm, L = 55mm, m = 0,35kg.

Part no. 052213 (size G - T69 require one Common mode filter per PEBB).

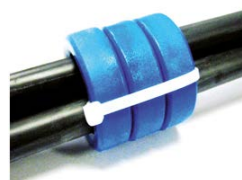

Extended options for Emotron VFX/FDU 2.0

Brake resistors



VPR= Compact – IP54 with 0.75 m shielded cable.

BEGT= Resistor with stainless steel alloy grid – IP20 or IP23 with thermo contact.

For dynamic braking by connection to the drive brake chopper output (optional)

Type	Resistor power [kW] in % duty cycle					Dimensions H x W x D [mm]	
	100 (>1.5 min)	60 (1 min < t ≤1.5 min)	40 (≤ 1 min)	25	6	IP54	
VPR 200-__R	0.2		0.47	0.74	3.6	200x60x31	–
VPR 300-__R	0.3		0.705	1.11	5.4	250x60x31	–
VPR 400-__R	0.4		0.94	1.48	7.2	301x60x31	–
VPR 500-__R	0.5		1.175	1.85	9.0	370x60x31	–
DEGT1VPR1000S_R-S	1		2.0	3.7	13.0	542x98x170	–
						IP20	IP23
BEGT 13#05-__R	2.5	3.25	4.25	6.25	21.0	301x483x326	500x483x326
BEGT 13#08-__R	4.0	5.2	6.8	10.0	34.0	301x483x326	500x483x326
BEGT 13#10-__R	5.0	6.5	8.5	12.5	42.5	301x483x326	500x483x326
BEGT 14#15-__R	7.5	9.8	12.7	18.7	64.0	301x483x426	500x483x426
BEGT 15#20-__R	10.0	13.0	17.0	25.0	85.0	301x483x526	500x483x526
BEGT 17#30-__R	15.0	19.5	25.5	37.5	127.0	301x483x740	500x483x740
BEGT 25#40-__R	20.0	26.0	34.0	50.0	170.0	601x484x526	800x484x526
BEGT 27#60-__R	30.0	39.0	51.0	75.0	255.0	601x484x736	800x484x736
BEGT 37#90-__R	40.0	52.0	68.0	100.0	340.0	1021x484x736	1181x484x736
BEGT 47#120-__R	50.0	65.0	85.0	125.0	425.0	1321x483x736	301x483x736
2xBEGT 27#60-__R	60.0	78.0	102.0	150.0	510.0	2x(601x484x736)	2x(800x484x736)
2xBEGT 37#78-__R	70.0	91.0	119.0	175.0	600.0	2x(1021x484x736)	2x(1181x484x736)
2xBEGT 37#90-__R	80.0	104.0	136.0	200.0	680.0	2x(1021x484x736)	2x(1181x484x736)
2xBEGT 47#120-__R	100.0	130.0	170.0	250.0	850.0	2x(1321x483x736)	2x(1481x483x736)

= 2: IP20, example BEGT 13205

= 4: IP23, example BEGT 13405

__R: resistance in ohm, example 26R=26 ohm

__R_: resistance in ohm, example 6R5=6.5 ohm

t : Braking time

Liquid cooling

Drive modules in frame sizes E - O and F69 - T69 are available in a liquid cooled version. These units are designed for connection to a liquid cooling system, normally a heat exchanger of liquid-liquid or liquid-air type. Heat exchanger is not part of the liquid cooling option. Drive units with parallel power modules (frame size H - T69) are delivered with a dividing unit for connection of the cooling system. The drive units are equipped with rubber hoses with leak-proof quick couplings.



Filter selection guide

Phenomenon	FILTERS				
	Common mode filter	Output choke	Output choke & overshoot clamp	Sine wave filter	All-pole sine wave filter
Common mode currents	Effective	Limited effect	Limited effect	Effective	Very effective
Bearing currents	Effective				Very effective
Voltage spikes U-V-W		Limited effect	Very effective	Very effective	Very effective
Voltage spikes U-PE		Limited effect	Effective	Limited effect	Very effective
dU/dt		Effective	Effective	Very effective	Very effective
Minimize motor audible noise		Limited effect	Limited effect	Effective	Effective
EMC conducted emission	Limited effect	Limited effect	Limited effect	Effective	Very effective

Recommendations with the different supply voltages up to and including 480 V

Situation	FILTERS				
	Common mode filter	Output choke	Output choke & overshoot clamp	Sine wave filter	All-pole sine wave filter
Not rated, delicate or difficult positioned motors	X			X	
Motor in frame size >280	X				
IEC 60034-17 motor		X			
IEC 60034-25 curve A motor	Cable lengths 0-100m**				
	Cable lengths 100-200m	X			
	Cable lengths 200-500m			X	
Dynamic use with frequently raised DC voltage (braking)			X		
Unshielded cables *					X

X = advised solution for this setup

Recommendations with the different supply voltages from 500 V - 690 V

Situation	FILTERS				
	Common mode filter	Output choke	Output choke & overshoot clamp	Sine wave filter	All-pole sine wave filter
Not rated, delicate or difficult positioned motors	X			X	
Motor in frame size >280	X				
3 kV isolation windings **					
IEC 60034-25 curve B motor	Cable lengths 0-100m**				
	Cable lengths 100-200m		X		
	Cable lengths 200-500m			X	
Dynamic use with frequently raised DC voltage (braking)			X		
Unshielded cables *					X

X = advised solution for this setup

Remarks

Cable lengths should always be as short as possible.

The table is based on correct EMC wiring with shielded cable and proper EMC installation.

Voltage drop over the complete system must be less than 10% of the main supply.

Sine wave filters are only for use with Emotron FDU.

* Conducted interference limits on unshielded motor - lines according to EN61800-3, table 16.

** No marks in a row, means that there is no need to take precautions.

CAD drawings available on the web

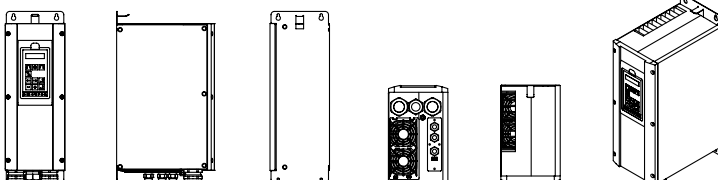

2D and 3D CAD drawings for Emotron AC drives, softstarters and monitors are available via our website. These will assist anyone working with our products, for example, consultants, installers or machine builders. Visit www.emotron.com for direct access to all CAD documents.

Service and support secure the value of your investment

We provide service and support through all phases of the product life cycle in order to optimize your investment in Emotron products and systems.

Emotron services

- Consultation and engineering during the planning and conceptual phases of your project.
- Training for you to fully benefit from the Emotron products. Good user knowledge results in reduced operating costs, extended product lifetime and fewer process interruptions.
- Technical support from qualified technicians. In most markets we offer a 24-hour call service.
- Service on site including anything from commissioning to maintenance, fault remedy and repairs.
- Minimized downtime thanks to quick and reliable delivery of spare-parts and replacement equipment.
- Qualified workshop repairs at our repair centres.
- Local and global service and support provided by CG Drives & Automation's technical centres.
- Local and global service and support provided by CG Drives & Automation's authorized service partners with fully trained and certified technicians.

CG Drives & Automation Sweden AB retains the right to change specifications and illustrations in the text, without prior notification.

TECHNICAL CENTERS

NORDIC

CG Drives & Automation
Mörsaregatan 12
Box 222 25
SE-250 24 HELSINGBORG
Sweden
Phone: +46 42 16 99 00
Fax: +46 42 16 99 49
info.se@cgglobal.com

CENTRAL EUROPE

(Germany, Austria, Switzerland)
CG Drives & Automation
Gießergeweg 3
D-38855 WERNIGERODE
Germany
Phone: +49 (0)3943-920 50
Fax: +49 (0)3943-920 55
info.de@cgglobal.com

BENELUX

CG Drives & Automation
Polakkers 5
5531 NX BLADEL
Postbus 132
5530 AC BLADEL
The Netherlands
Phone: +31 (0)497 389 222
Fax: +31 (0)497 386 275
info.nl@cgglobal.com

