

**Stainless steel block type
ball valve with threaded ports**

Full bore - Length, face-to-face DIN 3202 V1, M3

DN 4-25 | PN 25-400

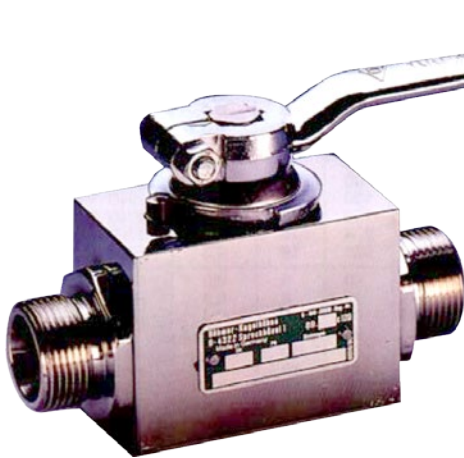

DN 12-25

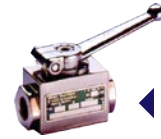
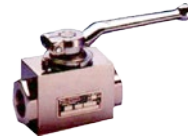

DN 4-10

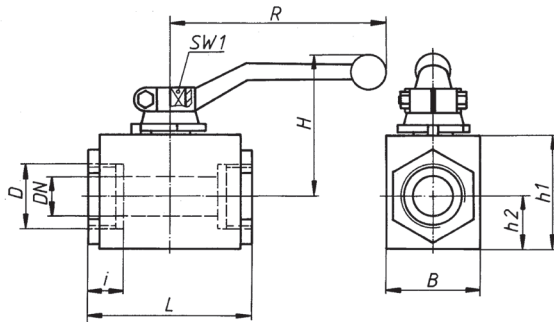



Materials	PN	DN	Type 1	Type 2
Body	25-400	4-25	Stainless steel 1.4571	Stainless steel 1.4571
Ball	25-400	4-25	Stainless steel 1.4571	Stainless steel 1.4571
	25	4-25	-	PTFE
Seals	150-400	4-25	Polyamide	PTFE

Please quote order-no. and type:
EBG V XXX.XXX / Type (1 o. 2)

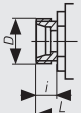
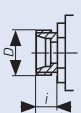

- On request with DIN DVGW acceptance for gas.
- The handle is included.
- Ball valves with PTFE seals are normally delivered with FPM O-rings.
- Special designs upon request.

Also available with TÜV component approval

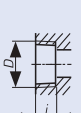
Type of connection	DN		PN		D	i	L	B	h1	h2	H	R	SW 1	Mass kg	Order-No.	
	mm	mm	Polyamide bar	PTFE												
2 	For compression fitting, light series, DIN 2353	4	6	-	25	M 12 x 1,5	10	76	25	30	12	44	60	8	0,3	EBG V 025.204
		6	8	-	25	M 14 x 1,5	10	76	25	30	12	44	60	8	0,3	EBG V 025.206
		8	10	-	25	M 16 x 1,5	11	76	25	30	12	44	60	8	0,3	EBG V 025.208
		10	12	-	25	M 18 x 1,5	11	80	30	35	15	50	60	8	0,4	EBG V 025.210
		12	15	-	25	M 22 x 1,5	12	96	35	45	18	55	100	10	0,8	EBG V 025.212
		16	18	-	25	M 26 x 1,5	12	105	40	50	21,5	68	130	10	1,0	EBG V 025.216
		20	22	-	25	M 30 x 2	14	110	45	55	24	70	130	10	1,3	EBG V 025.220
	25	28	-	25	M 36 x 2	14	120	55	65	30,5	82	180	12	2,2	EBG V 025.225	
	4	6	250*	250*	M 12 x 1,5	10	76	25	30	12	45	90	8	0,3	EBG V 250.204	
	6	8	250*	250*	M 14 x 1,5	10	76	25	30	12	45	90	8	0,3	EBG V 250.206	
	8	10	250*	250*	M 16 x 1,5	11	76	25	30	12	45	90	8	0,3	EBG V 250.208	
	10	12	250*	250*	M 18 x 1,5	11	80	30	35	15	51	90	8	0,4	EBG V 250.210	
	12	15	250*	250*	M 22 x 1,5	12	96	35	45	18	66	130	10	0,8	EBG V 250.212	
	16	18	160*	160*	M 26 x 1,5	12	105	40	50	21,5	68	130	10	1,0	EBG V 160.216	
	20	22	160*	160*	M 30 x 2	14	110	45	55	24	77	180	10	1,3	EBG V 160.220	
	25	28	100*	100*	M 36 x 2	14	120	55	65	30,5	82	180	12	2,2	EBG V 100.225	
	3 	For compression fitting, heavy series, DIN 2353	4	8	-	25	M 16 x 1,5	12	76	25	30	12	44	60	8	0,3
6			10	-	25	M 18 x 1,5	12	76	25	30	12	44	60	8	0,3	EBG V 025.306
8			12	-	25	M 20 x 1,5	12	76	25	30	12	44	60	8	0,3	EBG V 025.308
10			14	-	25	M 22 x 1,5	14	80	30	35	15	50	60	8	0,4	EBG V 025.310
12			16	-	25	M 24 x 1,5	14	96	35	45	18	55	100	10	0,8	EBG V 025.312
16			20	-	25	M 30 x 2	16	105	40	50	21,5	68	130	10	1,0	EBG V 025.316
20			25	-	25	M 36 x 2	18	110	45	55	24	70	130	10	1,3	EBG V 025.320
25			30	-	25	M 42 x 2	20	120	55	65	30,5	82	180	12	2,2	EBG V 025.325
4			8	400	350	M 16 x 1,5	12	76	25	30	12	45	90	8	0,3	EBG V 400.304
6			10	400	350	M 18 x 1,5	12	76	25	30	12	45	90	8	0,3	EBG V 400.306
8		12	400	350	M 20 x 1,5	12	76	25	30	12	45	90	8	0,3	EBG V 400.308	
10		14	400	350	M 22 x 1,5	14	80	30	35	15	51	90	8	0,4	EBG V 400.310	
12		16	400	350	M 24 x 1,5	14	96	35	45	18	66	130	10	0,8	EBG V 400.312	
16		20	315	250	M 30 x 2	16	105	40	50	21,5	68	130	10	1,0	EBG V 315.316	
20		25	250	175	M 36 x 2	18	110	45	55	24	77	180	10	1,3	EBG V 250.320	
25		30	250	150	M 42 x 2	20	120	55	65	30,5	82	180	12	2,2	EBG V 250.325	
7 		BSP female thread, DIN ISO 228/1	4	-	-	25	G 1/8	11	50	25	30	12	44	60	8	0,3
	6		-	-	25	G 1/4	12,5	50	25	30	12	44	60	8	0,3	EBG V 025.706
	8		-	-	25	G 3/8	12,5	70	25	30	12	44	60	8	0,3	EBG V 025.708
	10		-	-	25	G 3/8	12,5	60	30	35	15	50	60	8	0,4	EBG V 025.710
	12		-	-	25	G 1/2	15	75	35	45	18	55	100	10	0,7	EBG V 025.712
	16		-	-	25	G 1/2	15	75	40	50	21,5	68	130	10	0,9	EBG V 025.716
	20		-	-	25	G 3/4	18	80	45	55	24	70	130	10	1,2	EBG V 025.720
	25		-	-	25	G 1	20	90	55	65	30,5	82	180	12	2,1	EBG V 025.725
	4		-	400	350	G 1/8	11	50	25	30	12	45	90	8	0,3	EBG V 400.704
	6		-	400	350	G 1/4	12,5	50	25	30	12	45	90	8	0,3	EBG V 400.706
	8		-	400	350	G 3/8	12,5	70	25	30	12	45	90	8	0,3	EBG V 400.708
	10		-	400	350	G 3/8	12,5	60	30	35	15	51	90	8	0,4	EBG V 400.710
12	-	400	350	G 1/2	15	75	35	45	18	66	130	10	0,7	EBG V 400.712		
16	-	315	250	G 1/2	15	75	40	50	21,5	68	130	10	0,9	EBG V 315.716		
20	-	250	175	G 3/4	18	80	45	55	24	77	180	10	1,2	EBG V 250.720		
25	-	250	150	G 1	20	90	55	65	30,5	82	180	12	2,1	EBG V 250.725		
8 	NPT female thread, ANSI/ASME B 1.20.1	4	-	-	25	NPT 1/8	11	50	25	30	12	44	60	8	0,3	EBG V 025.804
		6	-	-	25	NPT 1/4	12,5	50	25	30	12	44	60	8	0,3	EBG V 025.806
		8	-	-	25	NPT 3/8	12,5	70	25	30	12	44	60	8	0,3	EBG V 025.808
		10	-	-	25	NPT 3/8	12,5	60	30	35	15	50	60	8	0,4	EBG V 025.810
		12	-	-	25	NPT 1/2	15	75	35	45	18	55	100	10	0,7	EBG V 025.812
		16	-	-	25	NPT 1/2	15	75	40	50	21,5	68	130	10	0,9	EBG V 025.816
		20	-	-	25	NPT 3/4	18	80	45	55	24	70	130	10	1,2	EBG V 025.820
		25	-	-	25	NPT 1	20	90	55	65	30,5	82	180	12	2,1	EBG V 025.825
		4	-	400	350	NPT 1/8	11	50	25	30	12	45	90	8	0,3	EBG V 400.804
		6	-	400	350	NPT 1/4	12,5	50	25	30	12	45	90	8	0,3	EBG V 400.806
		8	-	400	350	NPT 3/8	12,5	70	25	30	12	45	90	8	0,3	EBG V 400.808
		10	-	400	350	NPT 3/8	12,5	60	30	35	15	51	90	8	0,4	EBG V 400.810
12	-	400	350	NPT 1/2	15	75	35	45	18	66	130	10	0,7	EBG V 400.812		
16	-	315	250	NPT 1/2	15	75	40	50	21,5	68	130	10	0,9	EBG V 315.816		
20	-	250	175	NPT 3/4	18	80	45	55	24	77	180	10	1,2	EBG V 250.820		
25	-	250	150	NPT 1	20	90	55	65	30,5	82	180	12	2,1	EBG V 250.825		