

XT110C - XT111C - XT110D - XT111D

Single Stage Digital Controller with Multi Probe Input



1. GENERAL WARNING

1.1 PLEASE READ BEFORE USING THIS MANUAL

- This manual is part of the product and should be kept near the instrument for easy and quick reference.
- The instrument shall not be used for purposes different from those described hereunder. It cannot be used as a safety device.
- Check the application limits before proceeding.

1.2 SAFETY PRECAUTIONS

- Check the supply voltage is correct before connecting the instrument.
- Do not expose to water or moisture: use the controller only within the operating limits avoiding sudden temperature changes with high atmospheric humidity to prevent formation of condensation
- Warning: disconnect all electrical connections before any kind of maintenance.
- The instrument must not be opened.
- In case of failure or faulty operation send the instrument back to the distributor or to "DIXELL S.p.A." (see address) with a detailed description of the fault.
- Consider the maximum current which can be applied to each relay (see Technical Data).
- Ensure that the wires for probes, loads and the power supply are separated and far enough from each other, without crossing or intertwining.
- In case of applications in industrial environments, the use of mains filters (our mod. FT1) in parallel with inductive loads could be useful.

2. GENERAL DESCRIPTION

The XT110C, XT111C and XT110D, XT111D (DIN RAIL format) are single-stage ON/OFF controllers for temperature, humidity and pressure applications with direct or inverse action, user-selectable. The analogue input type can be set by parameter between the following, according to the model:

- PTC, NTC;
- PTC, NTC, Pt100, Thermocouple J, K, S;
- 4÷20mA, 0÷1V, 0÷10V.

3. FIRST INSTALLATION

3.1 PROBE SETTING

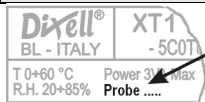

The pre-set probe type is written on the label of the instrument, see picture. If it is different from the probe that has been used, set the probe following procedure below

3.1.1 How to set the probe.

1. Enter the programming menu by pressing the SET+ ▾ for 3s.
2. Select the **Pbc (Probe configuration)** parameter and push the SET key.
3. Set the kind of probe:
 - a. **Controller for temperature:** Pt= Pt100, J = J thermocouple, c = K thermocouple, S = S thermocouple; Ptc = PTC; ntc = ntc.
 - b. **Controller with current or voltage inputs:** cur=4÷20mA, 0-1= 0÷1V, 10= 0÷10V
4. Push the SET key to confirm it.
5. Switch the controller off and on again.

NOTE: Before proceeding check and, if necessary, set with appropriate values the **Minimum Set Points (LS1 e LS2)** and **Maximum Set Points (US1 e US2)**. See also the paragraphs concerning the programming.

4. FRONT PANEL COMMANDS

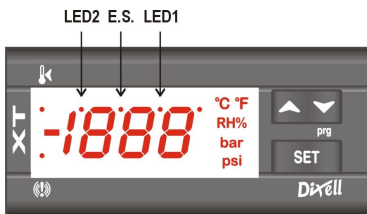

SET: To display and modify target set point; in programming mode it selects a parameter or confirm an operation.

TO SWITCH THE INSTRUMENT ON/OFF: If the function is enabled (par. onF=yES), by pressing the SET key for more than 4s the controller is switched OFF. To switch the instrument on again press the SET key.

▲ **UP:** in programming mode it browses the parameter codes or increases the displayed value. Hold it pressed for a faster change

▼ **DOWN:** in programming mode it browses the parameter codes or decreases the displayed value. Hold it pressed for a faster change

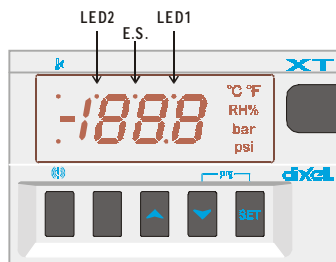

KEY COMBINATIONS:

- ▲ + ▾ To lock & unlock the keyboard.
- SET + ▾ To enter in programming mode.
- SET + ▲ To return to the room temperature display.

4.1 USE OF LEDS

A series of light points on the front panels is used to monitor the loads controlled by the instrument. Each LED function is described in the following table.

LED	MODE	FUNCTION
	ON	Output relay enabled
LED1	Flashing	- Programming Phase (flashing with LED2)
LED2	Flashing	- Programming Phase (flashing with LED1)
E.S.	ON	Energy saving activated by digital input
	ON	- ALARM signal - In "Pr2" indicates the parameter is also present in "Pr1"

4.2 TO SEE THE SETPOINT

1. Push and release the SET key to see the Set point value;
2. To come back to the normal display push again the SET key or wait 10s.

4.3 TO CHANGE THE SETPOINT

1. Hold pushed the SET key for 3s to change the Set point value;
2. The value of the set point will be displayed and the LED1 & 2 start blinking;
3. To change the Set value push the ▲ or ▼ arrows within 10s.
4. To memorise the new set point value push the SET key again or wait 10s.

4.4 TO ENTER THE PARAMETERS LIST "PR1"

To enter the parameter list "Pr1" (user accessible parameters) operate as follows:

1. Push for 3s the SET + ▾ keys (LED1 & 2 start blinking).
2. The controller will display the first parameter present in the Pr1 menu.

4.5 TO ENTER THE PARAMETERS LIST "PR2"

The "Pr2" parameter list contains the configuration parameters. A security code is required to enter it.

1. Enter the "Pr1" level, see above paragraph.
2. Select "Pr2" parameter and press the "SET" key.
3. The "PAS" flashing message is displayed, shortly followed by "0 -" with a flashing zero.
4. Use ▲ or ▼ to input the security code in the flashing digit; confirm the figure by pressing "SET".

The security code is "321".

5. If the security code is correct the access to "Pr2" is enabled by pressing "SET" on the last digit.

Another possibility is the following:

After switching ON the instrument, within 30 seconds, push SET + ▾ keys together for 3s: the Pr2 menu will be entered.

4.6 HOW TO MOVE A PARAMETER FROM THE "PR2" MENU TO "PR1" AND VICEVERSA.

Each parameter present in "Pr2" MENU can be removed or put into "Pr1", user level, by pressing "SET + ▾". In "Pr2" when a parameter is present in "Pr1" the LED (E.S.) is on.

4.7 HOW TO CHANGE A PARAMETER

To change a parameter value operates as follows:

1. Enter the Programming mode
2. Select the required parameter.
3. Press the "SET" key to display its value.
4. Use "UP" or "DOWN" to change its value.
5. Press "SET" to store the new value and move to the following parameter.

TO EXIT: Press SET + UP or wait 15s without pressing a key.

NOTE: the set value is stored even when the procedure is exited by waiting the time-out to expire.

4.8 HOW TO LOCK THE KEYBOARD



1. Keep pressed for more than 3 s the the ▲ and ▼ keys.
2. The "POF" message will be displayed and the keyboard will be locked. At this point it will be possible only to see the set point or the MAX o Min temperature stored
3. If a key is pressed more than 3s the "POF" message will be displayed.

4.9 TO UNLOCK THE KEYBOARD

Keep pressed together for more than 3s the the ▲ and ▼ keys, till the "Pon" message will be displayed.

4.10 ON/OFF FUNCTION

TO SWITCH THE INSTRUMENT ON/OFF: If the function is enabled (par. onF=yES), by pressing the SET key for more than 4s the controller is switched OFF. To switch the instrument on again press the SET key.

5. PROBES AND MEASURING RANGE

Probe	Down Scale	Full Scale
NTC	-40° C / -40° F	110° C / 230° F
PTC	-50° C / -58° F	150° C / 302° F
Pt100	-200° C / -328° F	600° C / 1112° F
TcK	0° C / 32° F	1300° C / 1999° F
TcJ	0° C / 32° F	600° C / 1112° F
TcS	0° C / 32° F	1400° C / 1999° F

6. LIST OF PARAMETERS

REGULATION

Hy1 Differential: (-Full Sc. / Full Sc.) Intervention differential for set point. It can be set with positive value or with negative value. The kind of action (direct or inverse) depends on the S1C parameter (in or di).

LS1 Minimum set point: (Down Sc.= Set) Sets the minimum acceptable value for the set point.

US1 Maximum set point: (Set= Full Sc.) Sets the maximum acceptable value for set point.

S1C Action type: **S1C=in** inverse action (heating/ humidifying /increase pressure); **S1C=dir** direct action (cooling / dehumidifying /decrease pressure).

AC Anti-short cycle delay: (0÷250 sec) Minimum time between the switching off and the following switching on

on Minimum time a stage stays switched ON (0÷250 sec)

ono: Minimum time between 2 following switching ON of the same load (0÷120 min).

ALARMS

ALC Temperature alarms configuration: it determines if alarms are relative to set point or referred to absolute values.
rE relative to set point; **Ab** absolute temperature

ALL Minimum alarm:
with ALC=rE: relative to set point, (0÷|Down Sc.-Set|) this value is subtracted from the set point. The alarm signal is enabled when the probe values goes below the "SET-ALL" value.
with ALC=Ab absolute value, minimum alarm is enabled when the probe values goes below the "ALL" value.

ALU Maximum alarm:
with ALC=rE: alarm relative to set point, (0÷|Full Sc.-Set|) Maximum alarm is enabled when the probe values exceeds the "SET+ALU" value.
with ALC=Ab: absolute alarm, (Set+Full Sc.) Maximum alarm is enabled when the probe values exceeds the "ALU" value.

ALH Differential for alarm recovery: (0,1÷Full scale) the alarm recovers when probe value is higher than Alarm value + ALH.

ALd Alarm delay:(0÷999 min) time interval between the detection of an alarm condition and alarm signalling.

dAO Delay of alarm at start-up: (0÷23.5h) time interval between the detection of the alarm condition after instrument power on and alarm signalling.

So1 Relay status with faulty probe: So1=oFF open; So1=on closed.

tbA Status of alarm relay after pushing a key. (XT111C/ XT111D only): oFF = relay disabled; on = relay enabled.

AS Alarm relay configuration (XT111C/ XT111D only): cL = 4-6 terminals open with alarm; oP = 4-6 terminals closed with alarm.

PROBES AND DISPLAY

LCI Start of scale, only with current or voltage input: (with rES = in, dE, cE: -99.00÷199.00, with rES=iRE -999÷1999) Adjustment of read out corresponding to 4mA or 0V input signal.

UCI End of scale, only with current or voltage input (with rES = in, dE, cE: -99.00÷199.00, with rES=iRE -999÷1999) Adjustment of read out corresponding to 20mA or 1V or 10V input signal.

oPb Probe calibration: (-999÷999) allows to adjust possible offset of the probe.

rES Resolution: select the resolution of the controller.
in= integer (-99÷199);
dEC= 1 decimal point (-99.0÷199.0),
cE = 2 digits after the decimal point (-99.00÷199.00) **only for current or voltage input,**
iRE = integer, large scale (-999÷1999) **only for current or voltage input.**
WARNING: if rES is changed from "iRE" to another value, all the parameters values expressed in degrees: SET, Hy1, LS1, uS1, ALL, ALu, ALH, LCI, uCi, LAo, uAo, HES, have to be checked and set.
NOTE: the decimal point selection is not available on models with thermocouple input.

Udm Measurement unit: it depends on models:
for temperature: °C = Celsius; °F = Fahrenheit.
with 4÷20mA, 0÷1V, 0÷10V input : 0= °C; 1= °F, 2= %RH, 3=bar, 4=PSI, 5=no measurement unit.

PbC Probe selection: it sets the kind of probe. It depends on models
for temperature NTC/PTC: Ptc = PTC; ntc = ntc.
for temperature standard: Pt= Pt100, J = J thermocouple, c = K thermocouple, S = S thermocouple; Ptc = PTC; ntc = ntc.
with 4÷20mA, 0÷1V, 0÷10V input : cur=4÷20mA, 0-1= 0÷1V, 10= 0÷10V.

P3F Third wire presence for Pt100 probe: for using 2 or 3 wires Pt100 probes: **no** = 2 wires probe; **yES** = 3 wires probe.

ANALOG OUTPUT – ONLY FOR XT110D, XT111D - OPTIONAL

AOC Analog output configuration (only for models with analog output):
AOC=Pb Probe reading. The analog output parameters LAO and UAO are independent and correspond to the absolute read-out probe signal.
AOC=Er Probe-Set Point. the analog output parameters LAO and UAO are related to the Set.

LAO Lower analog output limit: (only for models with analog output) minimum value of temperature associated to the 4mA analog output. This value can be absolute or relative to the Set Point by setting the AOC parameter.

UAO Upper analog output limit: (only for models with analog output) maximum value of temperature associated to the 20mA analog output. This value can be absolute or relative to the Set Point by setting the AOC parameter.

SAO Analog output safety with probe fault (only for models with analog output): determines what state the analog output should assume when the probe is faulty:
SAO = oFF: analog output = 40mA. **SAO = on:** analog output = 20mA

DIGITAL INPUT

HES Set point change during during the Energy Saving cycle : (Down Sc./Full Sc.) sets the variation of the set point during the Energy Saving cycle.

i1F Digital input operating mode: configure the digital input function: c-H = to invert the kind of action: direct - reverse;
oFF = to switch the controller off.; **AUS** = Not used; **HES** = Energy Saving; **EAL** = generic external alarm; **bAL** = serious external alarm: it switches off the loads.

i1P Digital input polarity:
CL : the digital input is activated by closing the contact;
OP : the digital input is activated by opening the contact

did Digital input alarm delay: (0÷255 min) delay between the detection of the external alarm condition (i1F = EAL or i1F = bAL) and its signalling.

OTHER

Adr RS485 serial address (0÷247) identifies the instrument within a control or supervising system.
onF Switching ON/OFF enabling from keyboard: (no = disabled; yES=enabled) It permits the switching ON/OFF of the instrument by pressing the SET key for more than 4s.

Ptb Parameters table: (read only) Shows the code of the parameters map.
rEL Software release: (read only)
Pr2 To access the Pr2 parameter programming menu.

7. INSTALLATION AND MOUNTING

Instrument XT110C and XT111C shall be mounted on vertical panel, in a 29x71 mm hole, and fixed using the special brackets supplied.
 Instruments XT110D, XT111D, shall be mounted on an omega DIN rail (3). To obtain an IP65 protection grade use the front panel rubber gasket (mod. RG-C) as shown in figure.
 The temperature range allowed for correct operation is 0÷+60 °C. Avoid places subject to strong vibrations, corrosive gases, excessive dirt or humidity. The same recommendations apply to probes. Let air circulate by the cooling holes.

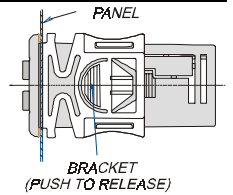

8. ELECTRICAL CONNECTIONS

The instruments are provided with screw terminal block to connect cables with a cross section up to 2,5 mm². Before connecting cables make sure the power supply complies with the instrument's requirements. Separate the input connection cables from the power supply cables, from the outputs and the power connections. Do not exceed the maximum current allowed on each relay, in case of heavier loads use a suitable external relay.

9. SERIAL CONNECTIONS

All models can be connected to the monitoring and supervising system XJ500 using the serial port. The external XJ485 serial module to interface the instrument with the monitoring and supervising system XJ500 is required.
 The standard ModBus RTU protocol it is used.
NOTE: XT110C or XT111C instruments with current or voltage input and 230V or 115V supply, cannot be connected to the XJ485 serial module.

10. HOW TO USE THE HOT KEY

10.1 HOW TO PROGRAM A HOT KEY FROM THE INSTRUMENT (UPLOAD)

1. Program one controller with the front keypad.
2. When the controller is ON, insert the "Hot key" and push **▲** key; the "uPL" message appears followed a by flashing "End"
3. Push "SET" key and the End will stop flashing.
4. Turn OFF the instrument remove the "Hot Key", then turn it ON again.

NOTE: the "Err" message is displayed for failed programming. In this case push again **▲** key if you want to restart the upload again or remove the "Hot key" to abort the operation.

10.2 HOW TO PROGRAM AN INSTRUMENT USING A HOT KEY (DOWNLOAD)

1. Turn OFF the instrument.
2. Insert a programmed "Hot Key" into the 5 PIN receptacle and then turn the Controller ON.
3. Automatically the parameter list of the "Hot Key" is downloaded into the Controller memory, the "doL" message is blinking followed a by flashing "End".
4. After 10 seconds the instrument will restart working with the new parameters.
5. Remove the "Hot Key"..

NOTE the message "Err" is displayed for failed programming. In this case turn the unit off and then on if you want to restart the download again or remove the "Hot key" to abort the operation.

11. DIGITAL INPUT

The controllers have 1 free contact digital input. It is programmable in 5 different configurations by the "i1F" parameter.

11.1 INVERT THE KIND OF ACTION: HEATING-COOLING (i1F = C-H)

This function allows to invert the regulation of the controller: from direct to inverse and viceversa.

11.2 REMOTE ON/OFF (i1F = OFF)

This function allows to switch ON and OFF the instrument.

11.3 GENERIC ALARM (i1F = EAL)

As soon as the digital input is activated the unit will wait for "did" time delay before signalling the "EAL" alarm message. The outputs status don't change. The alarm stops just after the digital input is deactivated.

11.4 SERIOUS ALARM MODE (i1F = BAL)

When the digital input is activated, the unit will wait for "did" delay before signalling the "bAL" alarm message. The relay outputs are switched OFF. The alarm will stop as soon as the digital input is deactivated.

11.5 ENERGY SAVING (i1F = HES)

The Energy Saving function allows to change the set point value as the result of the SET+ HES (parameter) sum. This function is enabled until the digital input is activated.

12. ALARM SIGNALS

Message	Cause	Outputs
"PFo"	Probe broken or absence	Alarm output ON; Output according to parameter "So1"
"PFc"	Probe short circuited	Alarm output ON; Output according to parameter "So1"
"HA"	Maximum alarm	Alarm output ON; Other outputs unchanged.
"LA"	Minimum alarm	Alarm output ON; Other outputs unchanged.
"EAL"	External alarm	Output unchanged.
"bAL"	Serious external alarm	Output OFF.

12.1 ALARM RELAY STATUS

Status of the instrument	XT111C		XT111D	
	AS = CL	AS= oP	AS = CL	AS= oP
Instrument off	4-6 closed	4-6 closed	20-21 closed	20-21 closed
Normal operating	4-6 closed	4-6 open	20-21 closed	20-21 open
Alarm present	4-6 open	4-6 closed	20-21 open	20-21 closed

12.2 SILENCING BUZZER / ALARM RELAY OUTPUT

Once the alarm signal is detected the buzzer, if present, can be disabled by pressing any key. **XT111C/XT111D**: the alarm relay status depends on the tbA parameter: with **tbA=YES** the alarm relay status depends on the tbA parameter: with **tbA=YES** the alarm relay remains enabled as long as the alarm lasts. The display signal remains as long as the alarm condition remains.

12.3 ALARM RECOVERY

Probe alarms "Pfo", "Pfc" start few seconds after the fault in the probe; they automatically stop few seconds after the probe restarts normal operation. Check connections before replacing the probe. Max. and min. alarms "HA" and "LA" automatically stop as soon as the variable returns to normal values. Alarms "bAL" and "EAL" recover as soon as the digital input is disabled.

13. TECHNICAL DATA

Housing: self extinguishing ABS.
Case: XT110C, XT111C: frontal 32x74 mm; depth 60mm;
 XT110D, XT111D: 4 DIN modules 70x85 mm; depth 61mm.
Mounting: XT110C, XT111C panel mounting in a 71x29 mm panel cut-out.
 XT110D, XT111D: DIN RAIL.
Protection: IP20.
Frontal protection: XT110C, XT111C IP65 with frontal gasket RG-C (optional).
Connections: Screw terminal block ≤ 2,5 mm² heat-resistant wiring.
Power supply: 12Vac/dc, ±10% or: 24Vac/dc ± 10% only for "C" format
 or 230Vac ± 10%, 50/60Hz or 110Vac, ± 10%, 50/60Hz
Power absorption: 3VA max.
Display: 3 ½ digits, red LED
Inputs: according to the order: NTC/PTC or NTC/PTC /Pt100 /Thermocouple J, K, S or 4÷20mA/ 0÷1V / 0÷10V
Relay outputs: Load relay SPDT 8(3)A, 250Vac
Alarm: (XT111C/XT111D) relay SPDT 8(3)A, 250Vac
Other output: buzzer (optional)
Kind of action: 1B; **Pollution grade:** normal, **Software class:** A;
Data storing: on the non-volatile memory (EEPROM);
Operating temperature: 0÷60 °C (32÷140°F); **Storage temperature:** -30÷85 °C (-22÷185°F).
Relative humidity: 20÷85% (no condensing)
Measuring and regulation range: according to the probe;
Controller Accuracy a 25°C: better than ±0,5% of full scale

14. CONNECTIONS

14.1 XT110C – 12V AC/DC OR 24V AC/DC

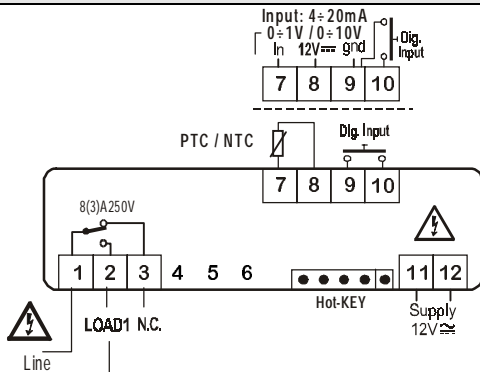

Probe: Pt100= 7 - 9 (8); Thermocouple J, K, S = 7(+); 9(-)
 24Vac/dc supply: 11-12

14.2 XT110C – 230V AC OR 115V AC

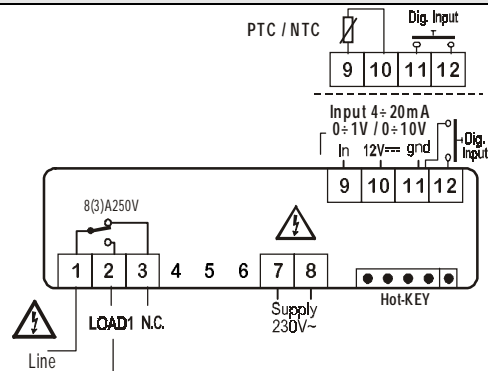

Pt100=9 -11 (10); Thermocouple J, K, S = 9(+)- 11(-)
 115Vac supply: 7-8

14.3 XT111C – 12VAC/DC OR 24VAC/DC

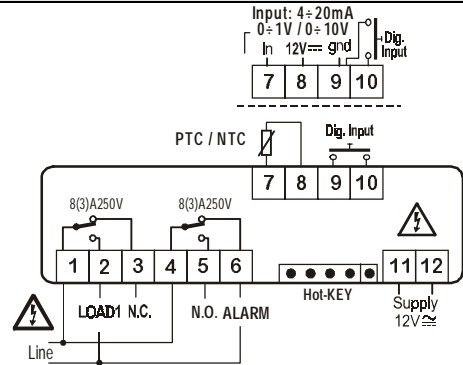

Probe: Pt100= 7 - 9 (8); Thermocouple J, K, S = 7(+); 9(-)
 24Vac/dc supply: 11-12

14.4 XT111C – 230V AC OR 115V AC

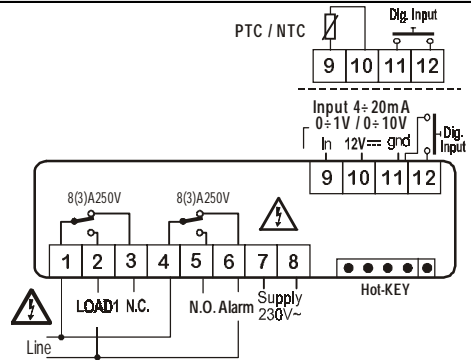

Probe: Pt100=9-11 (10); Thermocouple J, K, S = 9(+)- 11(-)
 115Vac supply: 7-8

14.5 XT110D – 230V AC OR 120V AC OR 24V AC

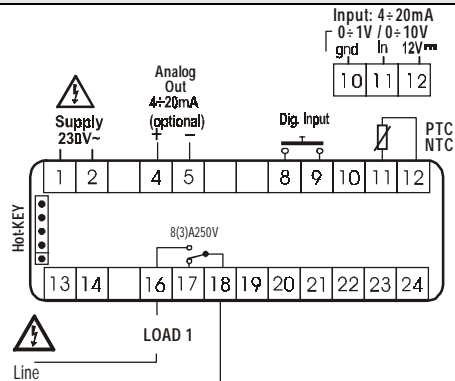

Probe: Pt100=11 - 10 (12); Thermocouple J, K, S = 11(+)- 10(-)
 115Vac supply: 1-2; 24Vac supply: 1-2

14.6 XT111D – 230V AC OR. 120V AC OR. 24V AC

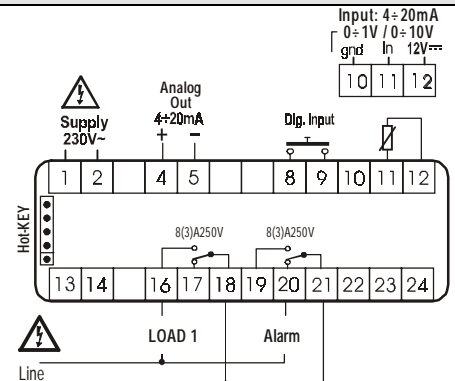

Probe: Pt100=11 - 10 (12); Thermocouple J, K, S = 11(+)- 10(-)
 115Vac supply: 1-2; 24Vac supply: 1-2

15. DEFAULT SETTING VALUES

COD	Name	Range	°C/°F	Lev
Set	Set point	LS1÷US1	0/32	-
Hy1	Differential	-Full Sc./ Full Sc.	-1/-2	Pr1
LS1	Minimum set point	Down Sc./ Set	min	Pr2
US1	Maximum set point	Set/ Full Sc.	max	Pr2
S1C	Action type output	in= Inverse; dir=direct	in	Pr2
Ac	Anti-short cycle delay:	0÷250 sec	0	Pr2
on	Minimum time a stage stays switched ON	0÷250 sec	0	Pr2
ono	Minimum time between 2 following switching ON of the same load	0÷120 min	0	Pr2
ALC	Alarm configuration	rE=relat.; Ab= absolute	rE	Pr2
ALL	Minimum alarm (ALC=rE) (ALC=Ab)	0 ÷ Start Sc.-Set Start Sc.÷ ALU	10.0/ 20	Pr2
ALU	Maximum alarm (ALC=rE) (ALC=Ab)	0 ÷ Full Sc.-Set ; ALL÷ Full Scale	10.0/ 20	Pr2
ALH	Alarm recovery differential	0÷ Full scale	2.0/4	Pr2
ALd	Alarm delay	0÷999 min	15	Pr2
dAO	Alarm delay at start up	0÷23h 50min	1.3	Pr2
So1	Output status with faulty pr.	oFF=open on=closed	oFF	Pr2
tbA ¹	Alarm relay disabling	no; yES	yES	Pr2
AS ¹	Alarm relay polarity	CL÷oP	oP	Pr2
Lci ²	Start scale with current or voltage input	-1999÷1999	various	Pr1
Uci ²	End scale with current or voltage input	-1999÷1999	various	Pr1
OPb	Probe calibration	-Full Sc./ Full Sc.	0.0	Pr1
rES	Resolution	in=NO; dE=0,1; cE=0,01	in	Pr2
UdM	Measurement unit (temp.) (current/voltage)	°C=°C; °F=°F; 0=°C; 1=°F; 2=RH; 3=bar; 4=PSI; 5=off	various	Pr1
PbC	Kind of probe	Pt=Pt100; J=tcJ; c= tck; S=tcS; Ptc=PTC; ntc= NTC; 0-1=0÷1V; 10= 0÷10V; cur=0÷20mA	various	Pr1
P3F	3 rd wire presence	no=2 wires; yES=3 wires	no	Pr2
Aoc ³	Analog output setting	Pb / Er	Pb	Pr2
LAo ³	Lower analog output limit:	Down Sc./ Full Sc.	0	Pr2
uAo ³	Upper analog output limit:	Down Sc./ Full Sc.	0	Pr2
SAo ³	Analog output safety with probe fault	oFF / on	oFF	Pr2
HES	Energy saving differential	Down Sc./ Full Sc.	0.0	Pr2
i1F	Digital input configuration	c-H / oFF / AuS / HES / EAL / bAL	EAL	Pr2
i1P	Digital input polarity	cL=closed; oP=open	cL	Pr2
did	Alarm delay for dig. input	0÷120m	0	Pr2
Adr	Serial address	0÷247	1	Pr2
OnF	oFF function enabling	no=not enabled; yES=enabled	no	Pr2
Ptb	Parameter table	Readable only	--	Pr2
rEL	Software release	Readable only	---	Pr2
Pr2	To access the Pr2	Readable only	321	Pr1

¹ Only for XT111C/XT111D;² Only for instrument with 4÷20mA or 0÷1V or 0÷10V;³ Only for instruments with analog output