

# CZ0201

**A**

**描述:**

CZ0201 防爆开关模块 (U 证), 需配合 CZ4000 系列按钮和开关操作头使用 (U 证), 必须装配在增安型壳体内。

- 有二种可选低温环境温度  $-40^{\circ}\text{C}/-55^{\circ}\text{C}$ 。
- 开关容量高达  $400\text{V}/16\text{A}$ , 触点材料有银点或镀金。
- 安装形式: 板前导轨型 (导轨安装或螺钉固定)  
板后型 (安装在面板上)
- IECEx 国际认证、ATEX 欧盟认证。

**Descriptions :**

CZ0201 Explosion-proof switch module (U certification) shall be used together with corresponding CZ4000 series operation head (U certification) and shall be mounted inside Ex e enclosure.

- Two low temperature ratings for option  $-40^{\circ}\text{C}/-55^{\circ}\text{C}$ .
- Contact capacity up to  $400\text{V}/16\text{A}$ . Contact has silver point or gold-plated type.
- Mounting: board front rail type (on rail or screw fixation)  
board back type (on panel).
- IECEx international certification, ATEX European certification.

- 二极开关模块由二个独立的按杆各控制一组触点, 选择不同功能的操作头可操作一组或二组触点。
- 四极开关模块由二个独立的压片各控制二组触点, 选择不同功能的操作头可操作二组或四组触点。
- H 型四极开关模块 (控制开关、负荷隔离开关) 有多种接触图可选, 除已有接触图外, 也可根据用户要求定制, 最多四组触点, 通过专用操作头操作。
- C 型防爆开关模块 (带开路短路检测) 有二组触点, 每组触点上配有电阻器, 专用于低功率信号电流的通断设计, 用于开路和短路检测, 选择不同功能的操作头可操作一组或二组触点。

- 2-pole switch module has two separate pressing rods, each controls a group of contact. One group or two groups of contacts can be controlled by different operation heads to have different functions.
- 4-pole switch module has two separate metal pressing elements, and each controls two groups of contacts. Two groups or four groups of contacts can be controlled by different functional operation heads.
- H type 4-pole switch module (control switch, load isolation switch) has various contact diagrams for option. Besides of listed contact diagram, others can be customized. Four groups of contacts are maximum and shall be operated by special operation head.
- Type C explosion-proof switch module (with open circuit/short circuit detection) has two groups of contacts, each group of contact has resistor especially for the contact of low-power signal current for open circuit and short circuit detection. With different functional operation head, one or two groups of contacts can be operated.

## 1 区和 2 区

## Zone 1 and zone 2

主要数据 Main technical data:

认证 Certification	防爆标志 Ex mark	符合标准 Meet the standard
China: CE18.5088U	Ex de II C Gb	GB3836
IECEX: IECEX CQM 08.0005U	Ex db eb II C Gb	IEC60079
ATEX: (DNV) Presafe 16 ATEX 9096U	Ⓜ II 2 G Ex db eb II C Gb	EN60079

适用范围: 用于 1 区和 2 区  
 使用环境温度:  $-55^{\circ}\text{C}/-40^{\circ}\text{C} \leq T_a \leq +60^{\circ}\text{C}$  ( $-55^{\circ}\text{C}$  可选)  
 工作温度:  $-55^{\circ}\text{C}/-40^{\circ}\text{C}$  to  $+90^{\circ}\text{C}$  ( $-55^{\circ}\text{C}$  可选)  
 防护等级: IP20  
 接线端子:  $2 \times 2.5\text{mm}^2$   
 机械寿命: 100 万次  
 符合电器标准: IEC/EN 60947-1、IEC/EN 60947-3  
 IEC/EN 60947-5-1

电器参数:

AC-12	AC-15	DC-13	AC-3	AC-23
400V/16A	400V/10A	110V/1A	400V/16A	400V/16A

额定冲击耐受电压  $U_{imp}$ : 6kV  
 额定短时耐受电流  $I_{ew}$ : 10kA  
 额定短路接通能力  $I_{em}$ : 17kA  
 短路保护: 16A / 500V  
 保护特性: gG (符合 IEC / EN60269-1)  
 板前导轨型安装: 导轨 TS35 × 7.5 或螺钉固定  
 板后型安装: 在 1-6mm 面板上











Intended use: zone 1&2  
 Ambient temperature:  $-55^{\circ}\text{C}/-40^{\circ}\text{C} \leq T_a \leq +60^{\circ}\text{C}$  ( $-55^{\circ}\text{C}$  Optional)  
 Service temperature:  $-55^{\circ}\text{C}/-40^{\circ}\text{C}$  to  $+90^{\circ}\text{C}$  ( $-55^{\circ}\text{C}$  Optional)  
 Degree of protection: IP20  
 Terminals:  $2 \times 2.5\text{mm}^2$   
 Mechanical life: 1 million times  
 Conformity to: IEC/EN 60947-1、IEC/EN 60947-3  
 IEC/EN 60947-5-1

Electrical data:









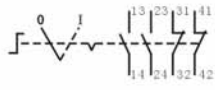
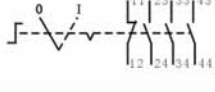
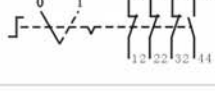

AC-12	AC-15	DC-13	AC-3	AC-23
400V/16A	400V/10A	110V/1A	400V/16A	400V/16A

Rated impulse withstand voltage: 6kV  
 Rated short-time withstand current: 10kA  
 Rated short-circuit making capacity: 17kA  
 Short-circuit protection: 16A / 500V  
 Protective characteristic: gG (conformity to IEC / EN60269-1)  
 Board front rail mounting: on TS35X7.5 rail or screw fixation  
 Board back mounting: on 1-6mm panel

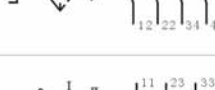
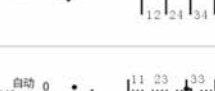
订购规格 Order specifications:

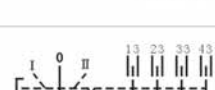
图样 Illustration	按钮触点 Button contact	重量 (kg) Weight		订购号 Order No.
		板前导轨型 Board front mounting rail type	板后型 Board back type	
板前导轨型 Board front mounting rail type   二极 2-Pole      四极 4-Pole	 1NC/1NO	0.069	0.080	CZ0201-□0□□
	 2NC			CZ0201-□1□□
	 2NO			CZ0201-□2□□
板后型 Board back type   二极 2-Pole      四极 4-Pole	 2NC/2NO	0.162	0.166	CZ0201-B□50□□
	 4NC			CZ0201-B□51□□
	 4NO			CZ0201-B□52□□
	 1NC/3NO			CZ0201-B□53□□
	 3NC/1NO			CZ0201-B□54□□
<p>6 — 板前导轨型 Board front mounting rail type      7 — 板后型 Board back type      安装形式 Mounting type</p> <p>S — 银点 Silver      G — 银点镀金 Gold-plated      触点材料 Contact materials</p> <p>L — <math>-40^{\circ}\text{C}</math>      H — <math>-55^{\circ}\text{C}</math>      使用环境温度 Ambient temperature</p>				

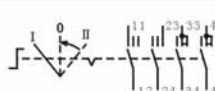









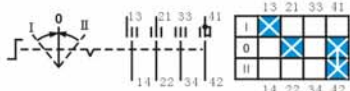

订购规格 Order specifications:

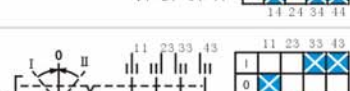
图样 Illustration	操作位置接触图 Contact schematic for operating position	重量(kg) Weight	订购号 Order No.
控制开关 Control switch  		0.211	<b>CZ0201-H601</b> □□
		0.211	<b>CZ0201-H602</b> □□
		0.211	<b>CZ0201-H603</b> □□
		0.211	<b>CZ0201-H604</b> □□
		0.211	<b>CZ0201-H605</b> □□
		0.211	<b>CZ0201-H606</b> □□
		0.211	<b>CZ0201-H607</b> □□
		0.211	<b>CZ0201-H608</b> □□
		0.211	<b>CZ0201-H609</b> □□
		0.211	<b>CZ0201-H610</b> □□
		0.211	<b>CZ0201-H611</b> □□
		0.211	<b>CZ0201-H612</b> □□
		0.211	<b>CZ0201-H613</b> □□
		0.211	<b>CZ0201-H614</b> □□

**标记说明  
Legends**
 锁定  
Locked

 弹簧返回  
Spring-return

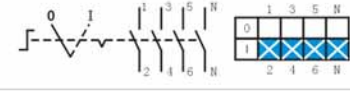
订购规格 Order specifications:

图样 Illustration	操作位置接触图 Contact schematic for operating position	重量(kg) Weight	订购号 Order No.
控制开关 Control switch  		0.211	<b>CZ0201-H618</b> □□
		0.211	<b>CZ0201-H626</b> □□
		0.211	<b>CZ0201-H631</b> □□
		0.211	<b>CZ0201-H637</b> □□
		0.211	<b>CZ0201-H646</b> □□
		0.211	<b>CZ0201-H650</b> □□
		0.211	<b>CZ0201-H656</b> □□
		0.211	<b>CZ0201-H659</b> □□
		0.211	<b>CZ0201-H660</b> □□
		0.211	<b>CZ0201-H668</b> □□
		0.211	<b>CZ0201-H674</b> □□
负荷开关 Load switch		0.211	<b>CZ0201-H697</b> □□
		0.211	<b>CZ0201-H698</b> □□
		0.211	<b>CZ0201-H699</b> □□

**S**—银点 Silver  
**G**—银点镀金 Gold-plated } 触点材料 Contact materials  
**L**—-40℃ } 使用环境温度 Ambient temperature  
**H**—-55℃ }

**A**

外形尺寸 Outline dimensions:

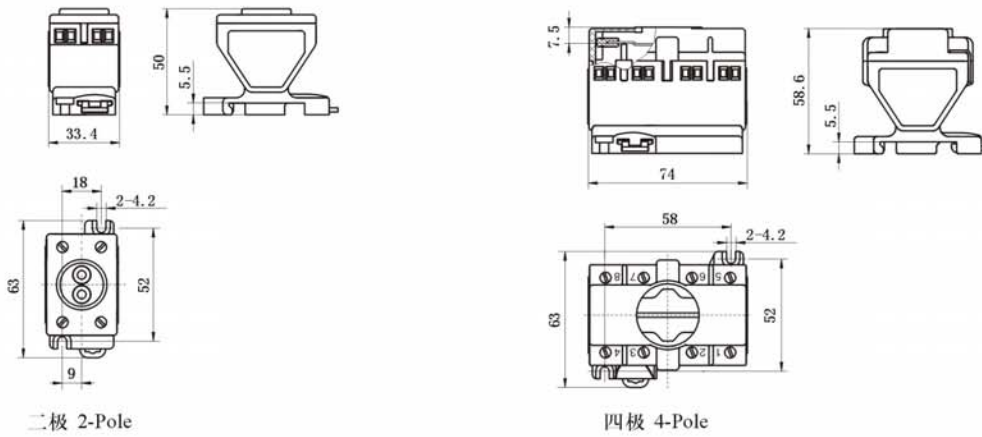

**CZ0201 板前导轨型防爆开关模块**  
Broad front mounting rail type explosion-proof switch module

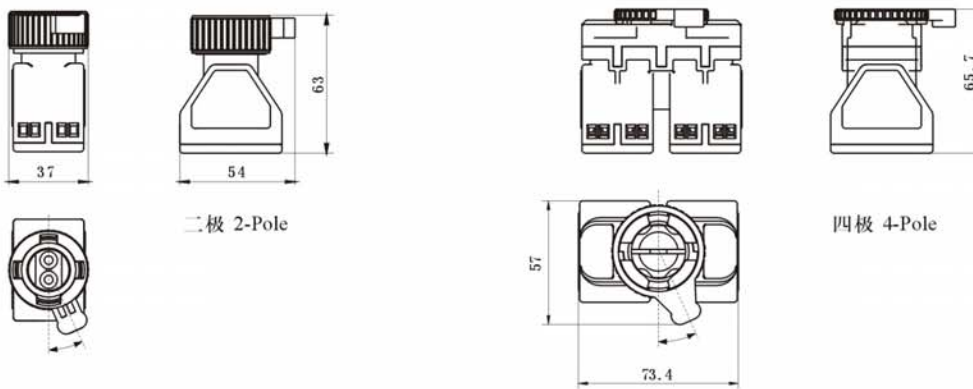

**CZ0201 板后型防爆开关模块**  
Board back type explosion-proof switch module

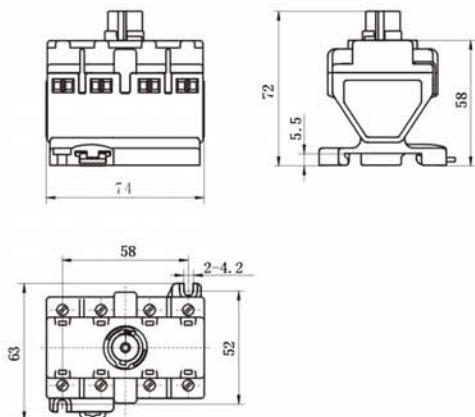

**CZ0201 板前导轨型防爆 H 四极开关模块**  
Board front mounting rail type explosion-proof H 4-Pole switch module

**主要数据 Main technical data:**

认证 Certification	防爆标志 Ex mark	符合标准 Meet the standard
China: CE18.5088U	Ex d e II C Gb	GB3836
IECEX: IECEX CQM 08.0005U	Ex db eb II C Gb	IEC60079
ATEX: (DNV) Presafe 16 ATEX 9096U	⊕ II 2 G Ex db eb II C Gb	EN60079

适用范围: 用于 1 区和 2 区  
 使用环境温度:  $-55^{\circ}\text{C}/-40^{\circ}\text{C} \leq T_a \leq +60^{\circ}\text{C}$  ( $-55^{\circ}\text{C}$  可选)  
 工作温度:  $-55^{\circ}\text{C}/-40^{\circ}\text{C}$  to  $+90^{\circ}\text{C}$  ( $-55^{\circ}\text{C}$  可选)  
 防护等级: IP20  
 接线端子:  $2 \times 2.5\text{mm}^2$   
 机械寿命: 100 万次  
 符合电器标准: IEC/EN 60947-1、IEC/EN 60947-3  
 IEC/EN 60947-5-1  
 电器参数: 

AC-15	DC-13
400V/10A	110V/1A

  
 额定功率: 最大 1.0W (单极)  
 触点材料: 银点镀金  
 触点电阻: 正常  $10\text{m}\Omega$   
 板前导轨型安装: 导轨  $\text{TS}35 \times 7.5$  或螺钉固定

Intended use: zone 1&2  
 Ambient temperature:  $-55^{\circ}\text{C}/-40^{\circ}\text{C} \leq T_a \leq +60^{\circ}\text{C}$  ( $-55^{\circ}\text{C}$  Optional)  
 Service temperature:  $-55^{\circ}\text{C}/-40^{\circ}\text{C}$  to  $+90^{\circ}\text{C}$  ( $-55^{\circ}\text{C}$  Optional)  
 Degree of protection: IP20  
 Terminals:  $2 \times 2.5\text{mm}^2$   
 Mechanical life: 1 million times  
 Conformity to: IEC/EN 60947-1、IEC/EN 60947-3  
 IEC/EN 60947-5-1  
 Electrical data: 

AC-15	DC-13
400V/10A	110V/1A

  
 Rated power: max. 1.0W (single pole)  
 Contact: gold-plated silver point  
 Contact resistance: normal  $10\text{m}\Omega$   
 Board front rail mounting: on  $\text{TS}35 \times 7.5$  rail or screw fixation

**A**

**订购规格 Order specifications:**

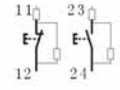
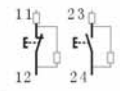
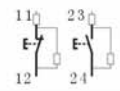
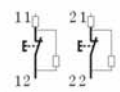
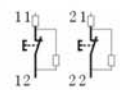
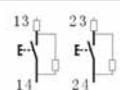
图样 Illustration	描述 Descriptions	接触图 Contact diagram	重量(kg) Weight	订购号 Order No.
	带开路和短路检测 With open-circuit and short-circuit detection	强制打开 Positive opening 	0.160	<b>CZ0201-C60G□21</b>
			0.160	<b>CZ0201-C60G□22</b>
			0.160	<b>CZ0201-C60G□23</b>
		强制打开 Positive opening 	0.160	<b>CZ0201-C61G□21</b>
			0.160	<b>CZ0201-C61G□22</b>
			0.160	<b>CZ0201-C62G□21</b>

L —  $-40^{\circ}\text{C}$     使用环境温度  
 H —  $-55^{\circ}\text{C}$     Ambient temperature

**外形尺寸 Outline dimensions:**

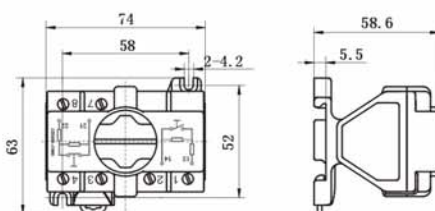

## CZ0202

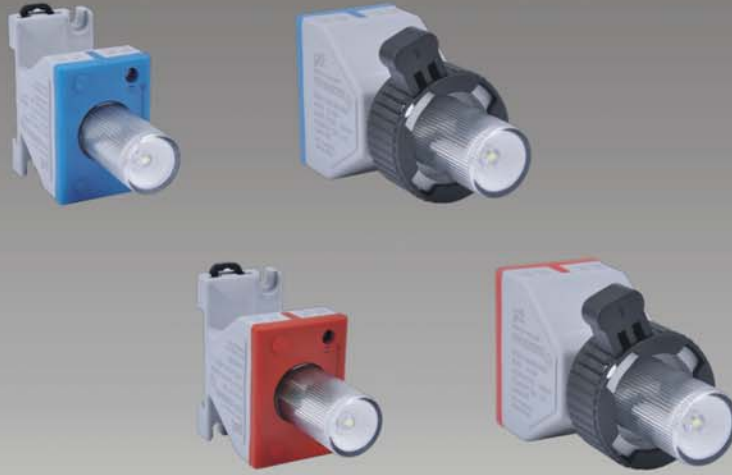

A

### 描述:

CZ0202防爆信号灯模块（U证），需配合CZ4000系列信号灯罩操作头使用（U证），必须装配在增安型壳体内。

- 有二种防爆标志 Ex db eb II C Gb / Ex ia II C Ga
- Ex ia 模块需配合安全栅使用
- IECEx国际认证、ATEX欧盟认证

- 有二种可选低温环境温度-40℃/-55℃
- 采用宽电压设计，有五种电压规格可选择
- 内置温度开关保护
- 长寿命LED光源
- 安装形式：板前导轨型（导轨安装或螺钉固定）  
板后型（安装在面板上）

### Descriptions :

CZ0202 Explosion-proof signal lamp module (U certification) shall be used together with corresponding CZ4000 series operation head (U certification) and shall be mounted inside Ex e enclosure.

- Two available Ex markings: Ex db eb II C Gb / Ex ia II C Ga.
- Ex ia module shall be used together with barrier.
- IECEx international certification, ATEX European certification.

- Two low temperature ratings for option -40℃/-55℃
- Wide voltage design, five voltage ratings for option
- Inside with temperature switch protection
- Long life LED light source
- Mounting: board front rail type (on rail or screw fixation)  
board back type (on panel)

0 区 ( Ex ia )

1 区和 2 区

Zone 0 ( Ex ia )

Zone 1 and zone 2

主要数据 Main technical data:

认证 Certification	防爆标志 Ex mark	符合标准 Meet the standard
China: CE18.5090U	Ex d e II C Gb / Ex ia II C Ga	GB3836
IECEX: IECEX CQM 08.0006U	Ex db eb II C Gb / Ex ia II C Ga	IEC60079
ATEX: (DNV) Presafe 16 ATEX 8568U	Ⓜ II 2G Ex db eb II C Gb / Ⓜ II 1G Ex ia II C Ga	EN60079

适用范围: 用于0区 (Ex ia), 用于1区和2区

使用环境温度:

-55℃/-40℃ < Ta < +60℃ (-55℃ 可选)

-55℃ < Ta < +55℃ (Ex ia)

-55℃/-40℃ < Ta < +50℃ (380V~400V AC) (-55℃ 可选)

工作温度: -55℃/-40℃ to +90℃ (-55℃ 可选)

防护等级: IP20

接线端子: 2 × 2.5mm<sup>2</sup>

额定电压: 10V - 28V AC/DC (Ex ia)

10V - 28V AC/DC (Ex db eb II C)

20V - 250V AC/DC

50V - 277V AC/DC

380V - 400V AC

光源: LED

功耗: Pmax ≤ 1W

板前导轨型安装: 导轨 TS35 × 7.5 或螺钉固定

板后型安装: 在 1-6mm 面板上

板前导轨型重量: 0.061kg

板后型重量: 0.070kg

Intended use: zone 0 (Ex ia), zone 1&2

Ambient temperature:

-55℃/-40℃ < Ta < +60℃ (-55℃ Optional)

-55℃ ≤ Ta ≤ +55℃ (Ex ia)

-55℃/-40℃ ≤ Ta ≤ +50℃ (380V~400V AC) (-55℃ Optional)

Service temperature: -55℃/-40℃ to +90℃ (-55℃ Optional)

Degree of protection: IP20

Terminals: 2 × 2.5mm<sup>2</sup>

Rated voltage: 10V - 28V AC/DC (Ex ia)

10V - 28V AC/DC (Ex db eb II C)

20V - 250V AC/DC

50V - 277V AC/DC

380V - 400V AC

Light source: LED

Power consumption: Pmax ≤ 1W

Board front rail mounting: on TS35 × 7.5 rail or screw fixation

Board back mounting: on 1-6mm panel

Weight(board front rail type): 0.061kg

Weight(board back type): 0.070kg

A

订购规格 Order specifications:

图样 Illustration	灯头颜色 Color of lamp	信号灯模块电压 Voltage of signal lamp module	防爆标志 Ex mark	订购号 Order No.
	白 White	10V - 28V AC/DC	Ex ia II C Ga	CZ0202-□00H
				6 — 板前导轨型 Board front mounting rail type 7 — 板后型 Board back type

安装形式  
Mounting type

订购规格 Order specifications:

图样 Illustration	灯头颜色 Color of lamp	信号灯模块电压 Voltage of signal lamp module	防爆标志 Ex mark	订购号 Order No.
	白 White	10V - 28V AC/DC	Ex db eb II C Gb	CZ0202-□03□
		20V - 250V AC/DC		CZ0202-□01□
		50V - 277V AC/DC		CZ0202-□04□
		380V - 400V AC		CZ0202-□02□
		6 — 板前导轨型 Board front mounting rail type 7 — 板后型 Board back type	安装形式 Mounting type	
		L — -40℃ H — -55℃	使用环境温度 Ambient temperature	



外形尺寸 Outline dimensions:

**A**

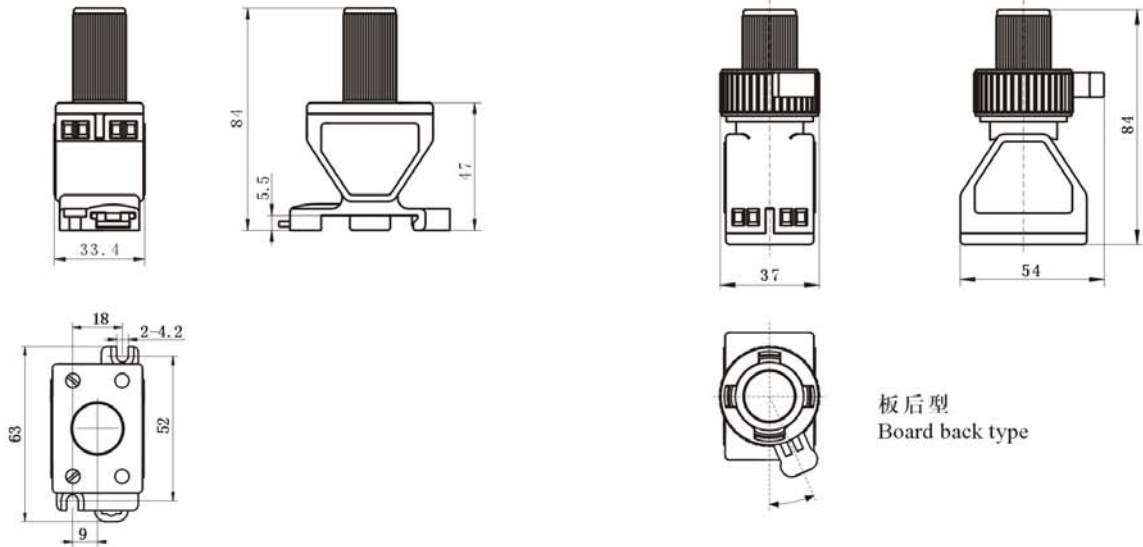

板前导轨型  
Board front mounting rail type

板后型  
Board back type

**描述:**

CZ0212防爆信号灯带按钮模块（U证），需配合CZ4000系列信号灯带按钮罩操作头使用（U证），必须装配在增安型壳体内。

- 有二种防爆标志 Ex db eb II C Gb / Ex ia II C Ga
- Ex ia 模块需配合安全栅使用
- IECEx国际认证、ATEX欧盟认证

- 有二种可选低温环境温度-40℃/-55℃
- 信号灯带按钮模块内带有一组1NC或1NO触点和一组信号灯组件
- 信号灯组件采用宽电压设计，有四种电压规格可选择
- 信号灯组件自带温度开关保护
- 信号灯组件采用长寿命LED光源
- 安装形式：板前导轨型（导轨安装或螺钉固定）  
板后型（安装在面板上）

**Descriptions :**

CZ0212 Explosion-proof signal lamp with button module (U certification) shall be used together with corresponding CZ4000 series operation head (U certification) and shall be mounted inside Ex e enclosure.

- Two available Ex markings: Ex db eb II C Gb / Ex ia II C Ga.
- Ex ia module shall be used together with barrier.
- IECEx international certification, ATEX European certification.

- Two low temperature ratings for option -40℃/-55℃
- Signal lamp with button has contact 1NC or 1NO and signal lamp element inside.
- Wide voltage design, four voltage ratings for option
- Inside with temperature switch protection
- Long life LED light source
- Mounting: board front rail type (on rail or screw fixation)  
Board back type (on panel)

**0 区 ( Ex ia )**
**Zone 0 ( Ex ia )**
**1 区和 2 区**
**Zone 1 and zone 2**

主要数据 Main technical data:

认证 Certification	防爆标志 Ex mark	符合标准 Meet the standard
China: CE18.5092U	Ex d e II C Gb / Ex ia II C Ga	GB3836
IECEX: IECEX CQM 11.0034U	Ex db eb II C Gb / Ex ia II C Ga	IEC60079
ATEX: (DNV) Presafe 16 ATEX 9083U	II 2G Ex db eb II C Gb / Ex ia II C Ga	EN60079

适用范围: 用于0区 (Ex ia), 用于1区和2区

使用环境温度:

-55℃/-40℃ ≤ Ta ≤ +60℃ (Ex db eb II C Gb) (-55℃ 可选)

-55℃ ≤ Ta ≤ +55℃ (Ex ia)

工作温度: -55℃/-40℃ to +90℃ (-55℃ 可选)

防护等级: IP20

接线端子: 2 × 2.5mm<sup>2</sup>

符合电器标准: IEC/EN 60947-1、IEC/EN 60947-5-1

按钮: 额定电压/额定电流: AC/DC 30V 100mA (Ex ia)  
AC 250V/10A DC24V/1A (Ex db eb II C)

使用类别: AC-15、DC-13

短路保护: 16A / 500V

保护特性: gG (符合 IEC / EN60269-1)

机械寿命: 30 万次

信号灯: 额定电压: 10V - 28V AC/DC (Ex ia)

10V - 28V AC/DC

20V - 250V AC/DC (Ex db eb II C)

50V - 277V AC/DC

光源: LED

功耗: P<sub>max</sub> ≤ 1W

板前导轨型安装: 导轨 TS35 × 7.5 或螺钉固定

板后型安装: 在 1-6mm 面板上

板前导轨型重量: 0.074kg

板后型重量: 0.083kg

Intended use: zone 0 (Ex ia), zone 1&2

Ambient temperature:

-55℃/-40℃ ≤ Ta ≤ +60℃ (Ex db eb II C Gb) (-55℃ Optional)

-55℃ ≤ Ta ≤ +55℃ (Ex ia)

Service temperature: -55℃/-40℃ to +90℃ (-55℃ Optional)

Degree of protection: IP20

Terminals: 2 × 2.5mm<sup>2</sup>

Conformity to: IEC/EN 60947-1, IEC/EN 60947-5-1

Button: Rated voltage/Rated current: AC/DC 30V 100mA (Ex ia)  
AC 250V/10A DC24V/1A (Ex db eb II C)

Utilization category: AC-15, DC-13

Short-circuit protection: 16A / 500V

Protective characteristic: gG (conformity to IEC / EN60269-1)

Mechanical life: 300 thousand times

Signal lamp: rated voltage: 10V - 28V AC/DC (Ex ia)

10V - 28V AC/DC

20V - 250V AC/DC (Ex db eb II C)

50V - 277V AC/DC

Light source: LED

Power dissipation: P<sub>max</sub> ≤ 1W

Board front rail mounting: on TS35 × 7.5 rail or screw fixation

Board back mounting: on 1-6mm panel

Weight (board front rail type): 0.074kg

Weight (board back type): 0.083kg

订购规格 Order specifications:

图样 Illustration	灯头颜色 Color of lamp	按钮触点 Button contact	防爆标志 Ex mark	信号灯电压 Voltage of signal lamp	订购号 Order No.
	白 White		Ex ia II C Ga	10V - 28V AC/DC	<b>CZ0212-□300H</b>
			Ex db eb II C Gb	10V - 28V AC/DC	<b>CZ0212-□303□</b>
				20V - 250V AC/DC	<b>CZ0212-□301□</b>
				50V - 277V AC/DC	<b>CZ0212-□304□</b>
	白 White		Ex ia II C Ga	10V - 28V AC/DC	<b>CZ0212-□400H</b>
			Ex db eb II C Gb	10V - 28V AC/DC	<b>CZ0212-□403□</b>
				20V - 250V AC/DC	<b>CZ0212-□401□</b>
				50V - 277V AC/DC	<b>CZ0212-□404□</b>

6 — 板前导轨型 Board front mounting rail type    7 — 板后型 Board back type  
安装形式    Mounting type

L — -40℃    H — -55℃  
使用环境温度    Ambient temperature

外形尺寸 Outline dimensions:

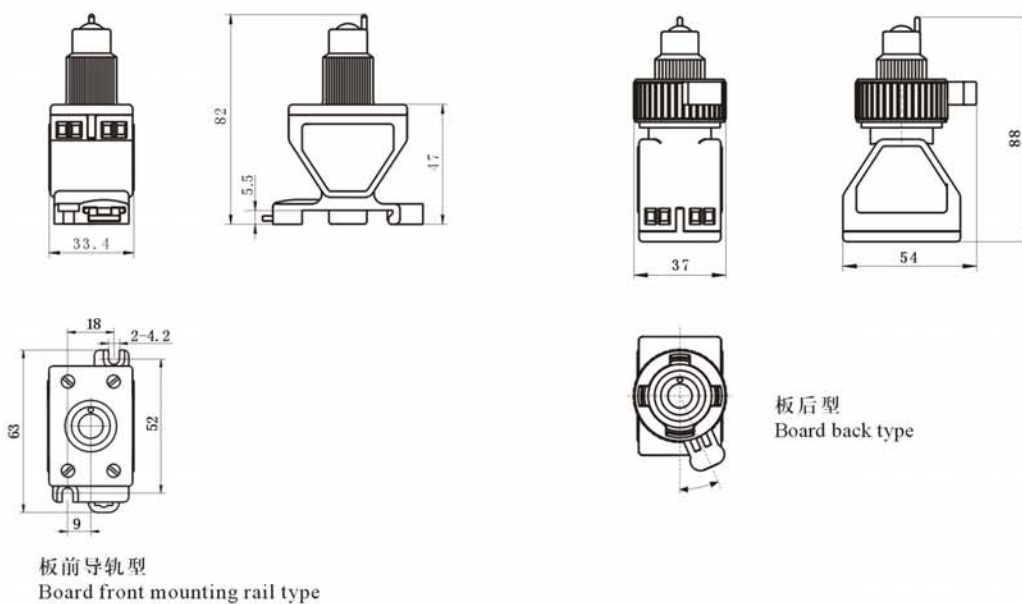

A

## CZ0203

**A**

### 描述:

CZ0203 防爆电位器模块 (U证), 需配合CZ4000系列电位器整定操作头使用 (U证), 必须装配在增安型壳体内。

- 有二种可选低温环境温度-40℃/-55℃。
- 防爆电位器模块安装型式分为板前导轨型和板后型。
- IECEx国际认证、ATEX欧盟认证。

### Descriptions :

CZ0203 Explosion-proof potentiometer module (U certification) shall be used together with CZ4000 series operation head (U certification) and shall be mounted inside Ex e enclosure.

- Two low temperature ratings for option -40℃/-55℃.
- Mounting types are available in board front rail and board back.
- IECEx international certification, ATEX European certification.

## 1 区和 2 区

## Zone 1 and zone 2

主要数据 Main technical data:

认证 Certification	防爆标志 Ex mark	符合标准 Meet the standard
China: CE18.5093U	Ex de II C Gb	GB3836
IECEX: IECEX CQM 11.0033U	Ex db eb II C Gb	IEC60079
ATEX: (DNV) Presafe 16 ATEX 9214U	Ex II 2G Ex db eb II C Gb	EN60079

适用范围: 用于 1 区和 2 区  
 使用环境温度:  $-55^{\circ}\text{C}/-40^{\circ}\text{C} \leq T_a \leq +60^{\circ}\text{C}$  ( $-55^{\circ}\text{C}$  可选)  
 工作温度:  $-55^{\circ}\text{C}/-40^{\circ}\text{C}$  to  $+90^{\circ}\text{C}$  ( $-55^{\circ}\text{C}$  可选)  
 防护等级: IP20  
 接线端子:  $2 \times 2.5\text{mm}^2$   
 额定电压: Max 200V DC  
 额定功率: Max 0.1W  
 刻度: 0 ~ 100%  
 标称阻值:  $100\Omega \sim 2\text{M}\Omega$   
 板前导轨型安装: 导轨  $\text{TS}35 \times 7.5$  或螺钉固定  
 板后型安装: 在 1~6mm 面板上  
 板前导轨型重量: 0.070kg  
 板后型重量: 0.080kg

Intended use: zone 1&2  
 Ambient temperature :  $-55^{\circ}\text{C}/-40^{\circ}\text{C} \leq T_a \leq +60^{\circ}\text{C}$  ( $-55^{\circ}\text{C}$  Optional )  
 Service temperature:  $-55^{\circ}\text{C}/-40^{\circ}\text{C}$  to  $+90^{\circ}\text{C}$  ( $-55^{\circ}\text{C}$  Optional )  
 Degree of protection: IP20  
 Terminal:  $2 \times 2.5\text{mm}^2$   
 Rated voltage: Max 200V DC  
 Rated power: Max 0.1W  
 Scale: 0 ~ 100%  
 Nominal resistance:  $100\Omega \sim 2\text{M}\Omega$   
 Board front rail mounting: on  $\text{Ts}35 \times 7.5$  rail or screw fixation  
 Board back mounting: on 1~6mm panel  
 Weight (board front rail type): 0.070kg  
 Weight (board back type): 0.080kg

A

订购规格 Order specifications:

图样 Illustration	原理图 Principal diagram	电阻值 Resistance value	订购号 Order No.
		100 $\Omega$	CZ0203-A□01/1□
		200 $\Omega$	CZ0203-A□02/1□
		500 $\Omega$	CZ0203-A□03/1□
		1000 $\Omega$	CZ0203-A□04/1□
		2000 $\Omega$	CZ0203-A□05/1□
		5000 $\Omega$	CZ0203-A□06/1□
		10000 $\Omega$	CZ0203-A□07/1□
		20000 $\Omega$	CZ0203-A□08/1□
		50000 $\Omega$	CZ0203-A□09/1□
		100000 $\Omega$	CZ0203-A□10/1□
		200000 $\Omega$	CZ0203-A□11/1□
		500000 $\Omega$	CZ0203-A□12/1□
		1000000 $\Omega$	CZ0203-A□13/1□
		2000000 $\Omega$	CZ0203-A□14/1□
		<p>6 — 板前导轨型 Board front mounting rail type                  7 — 板后型 Board back type</p> <p>L — <math>-40^{\circ}\text{C}</math>                  H — <math>-55^{\circ}\text{C}</math></p> <p>安装形式 Mounting type</p> <p>使用环境温度 Ambient temperature</p>	

外形尺寸 Outline dimensions:

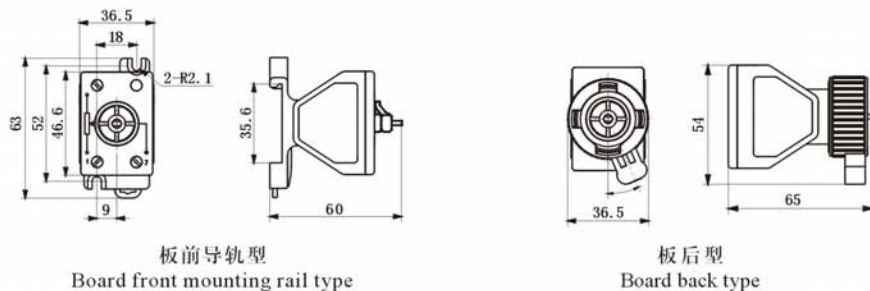

# CZ0205

**A**
**描述:**

CZ0205防爆电表模块（U证），需配合CZ4000表框使用（U证），必须装配在增安型壳体内。

- 电表模块安装可选导轨安装座（用于板前导轨安装），电表模块可垂直安装导轨上或水平安装导轨上，只需调整安装座方向即可。

- 板后安装支架（安装在面板上）
- 电表模块设有红色可调整警示指示针
- 电流表模块只要互感器次级电流相同，可更换刻度盘
- IECEx国际认证、ATEX欧盟认证

**Descriptions :**

CZ0205 Explosion-proof meter module (U certification) shall be used together with corresponding CZ4000 series calotte (U certification) and shall be mounted inside Ex e enclosure.

- Meter modules can be optional with mounting base (for board front rail mounting). It can be mounted on rail vertically or horizontally just to change the direction of mounting base.

- Mounting bracket for board back type (on panel).
- Meter module has warning pointer which can be regulated.
- Scale can be altered if the secondary current of ammeter module is same.
- IECEx international certification, ATEX European certification.

## 1 区和 2 区

## Zone 1 and zone 2

**主要数据 Main technical data:**

认证 Certification	防爆标志 Ex mark	符合标准 Meet the standard
China: CE14.5015U	Ex e IIC Gb (电流表 Ammeter) / Ex e mb II C Gb (电压表、电流表 Voltmeter, Ammeter)	GB3836
IECEX: IECEX CQM 14.0034U	Ex e IIC Gb (电流表 Ammeter) / Ex e mb II C Gb (电压表、电流表 Voltmeter, Ammeter)	IEC60079
ATEX: Sira 14ATEX3169U	Ⓜ II 2G Ex e IIC Gb (电流表 Ammeter) Ⓜ II 2G Ex e mb II C Gb (电压表、电流表 Voltmeter, Ammeter)	EN60079

适用范围: 用于 1 区和 2 区

工作温度: -40℃..+95℃

电表机构: 电磁式

精度: 1.5 级

电流表倍程: 2 倍, 5 倍

 接线端子: 2 × 2.5mm<sup>2</sup>

外形尺寸: 长 × 宽 × 高 (70.5 × 66 × 47.5mm)

Intended use: Can be used in zone 1 and zone 2

Operating temperature: -40℃..+95℃

Ammeter framework: Electromagnetic

Accuracy class: 1.5

Overload scale: 2 times, 5 times

 Terminals: 2 × 2.5mm<sup>2</sup>

Outline dimensions: L × W × H (70.5 × 66 × 47.5mm)

**A**
**CZ0205 防爆电流表模块 Explosion-proof ammeter module**

图样 Illustration	防爆标志 Ex mark	测量方式 Measuring way	过载倍程 Overload scale	量程 Measuring range	重量(kg) Weight	订购号 Order No.
	Ⓜ II 2G Ex e IIC Gb	直接测量 Direct measuring	2	0-1 / 2A 0-5 / 10A 0-10 / 20A	0.130	<b>CZ0205-A1</b> <b>CZ0205-A5</b> <b>CZ0205-A10</b>
		用互感器联接 For current transformer	2	0-1 / 2A 0-2.5 / 5A 0-5 / 10A 0-15 / 30A 0-25 / 50A 0-40 / 80A 0-50 / 100A 0-60 / 120A 0-75 / 150A 0-100 / 200A 0-150 / 300A 0-200 / 400A 0-250 / 500A 0-300 / 600A 0-400 / 800A 0-500 / 1000A 0-600 / 1200A	0.131	<b>CZ0205-A 01 / □2</b> <b>CZ0205-A 2.5 / □2</b> <b>CZ0205-A 5 / □2</b> <b>CZ0205-A 15 / □2</b> <b>CZ0205-A 25 / □2</b> <b>CZ0205-A 40 / □2</b> <b>CZ0205-A 50 / □2</b> <b>CZ0205-A 60 / □2</b> <b>CZ0205-A 75 / □2</b> <b>CZ0205-A 100 / □2</b> <b>CZ0205-A 150 / □2</b> <b>CZ0205-A 200 / □2</b> <b>CZ0205-A 250 / □2</b> <b>CZ0205-A 300 / □2</b> <b>CZ0205-A 400 / □2</b> <b>CZ0205-A 500 / □2</b> <b>CZ0205-A 600 / □2</b>
		用互感器联接 For current transformer	5	0-1 / 5A 0-2.5 / 12.5A 0-5 / 25A 0-15 / 75A 0-25 / 125A 0-40 / 200A 0-50 / 250A 0-60 / 300A 0-75 / 375A 0-100 / 500A 0-150 / 750A 0-200 / 1000A 0-250 / 1250A 0-300 / 1500A 0-400 / 2000A 0-500 / 2500A 0-600 / 3000A	0.125	<b>CZ0205-A 01 / □5</b> <b>CZ0205-A 2.5 / □5</b> <b>CZ0205-A 5 / □5</b> <b>CZ0205-A 15 / □5</b> <b>CZ0205-A 25 / □5</b> <b>CZ0205-A 40 / □5</b> <b>CZ0205-A 50 / □5</b> <b>CZ0205-A 60 / □5</b> <b>CZ0205-A 75 / □5</b> <b>CZ0205-A 100 / □5</b> <b>CZ0205-A 150 / □5</b> <b>CZ0205-A 200 / □5</b> <b>CZ0205-A 250 / □5</b> <b>CZ0205-A 300 / □5</b> <b>CZ0205-A 400 / □5</b> <b>CZ0205-A 500 / □5</b> <b>CZ0205-A 600 / □5</b>

 接次级电流的互感器 5A 5A  
 Connect to the secondary current transformer 1A 1A



CZ0205 防爆电流表(毫安表)、电压表模块 Explosion-proof ammeter (milammeter), voltmeter module

图样 Illustration	防爆标志 Ex mark	型式 Type	规格 Specification	重量 (kg) Weight	订购号 Order No.
		电压表(AC) Voltmeter	0-25V 0-40V 0-150V 0-250V 0-500V	0.183	<b>CZ0205-V 25</b> <b>CZ0205-V 40</b> <b>CZ0205-V 150</b> <b>CZ0205-V 250</b> <b>CZ0205-V 500</b>
		电流表(毫安表) (DC) Ammeter (milammeter)	0-20/40mA 4-20/40mA	0.184	<b>CZ0205-mA 11/□□</b> <b>CZ0205-mA 12/□□</b>

刻度盘 ←  
Scale

板前导轨型安装座 Board front mounting rail type mounting holder

图样 Illustration	描述 Specification	重量 (kg) Weight	件/包 Pcs/package	订购号 Order No.
	用于电表模块导轨安装座 Used for meter rail mounting	0.024	10	<b>0205-6WA</b>

板后型安装支架 Board back type mounting bracket

图样 Illustration	描述 Specification	重量 (kg) Weight	件/包 Pcs/package	订购号 Order No.
	用于电表模块安装在面板后面的支架 Used for meter panel mounting.	0.027	10	<b>0205-7WA</b>

电流表刻度盘 The scale of ammeter

图样 Illustration	用互感器联接(W) 刻度 For current transformer Scale	重量 (kg) Weight	件/包 Pcs/package	订购号 Order No.
<p>可互换刻度盘 Alternative scale</p>	0...1、2.5、5、15、25、 40、50、60、75、100、 150、200、250、300、 400、500、600	0.006	10	<b>0205-□/□-□</b> 

# 防爆模块+操作头

Explosion-proof module + operation head



调试与工作过程中，设备必须处于  
TESTING AND WORKING  
THE EQUIPMENT SHOULD BE

START

BODY UP

RPM SETTING

STOP

STOP

OFF

严禁带电开盖  
BEFORE OPENING