

Bimetal thermometers for industrial applications

Bimetal air duct thermometers



Bimetal thermometers for industrial applications

Technical specifications

Mechanical engineering, plant engineering, pipelines, boilers, heating technology

Type
D2

Nominal size
63 – 80 – 100 – 160

Measuring element
Bimetal helix

Accuracy class
1 (EN 13190)

Ranges °C
-20/+60, 0/60, 0/120, 0/160

Application area (EN 13190)
Continuous load: measuring range
Short-term: range

Operating pressure at thermowell
Max. 10 bar (statical)

Degree of protection
IP 41 (EN 60529)

Standard version

Connection
Stem brass, Ø 9 mm
Thermowell G½B, brass, removable

Mounting position
NG 63 – 80 – 100 – 160 centre back
NG 63 – 80 – 100 – 160 bottom

Dial
Aluminium, white,
Dial marking black

Pointer
Aluminium, black

Housing
Sheet steel galvanised

Push on bezel
Sheet steel nickel-plated

Window
Instrument glass

Options

- Other connection types
- Other ranges
- Other stem lengths



See page 362 for prices.



Bimetal air duct thermometers

Air conditioning, ventilation

Type
D2

Nominal size
63 – 80 – 100

Measuring element
Bimetal helix

Accuracy class
2 (EN 13190)

Ranges °C
-30/+50, -20/+60, -20/+40, 0/60

Application area
Full scale value

Degree of protection
IP 41 (EN 60529)

Connection
Stem brass, Ø 9 mm, mounting flange,
plastic Ø 60 mm, or back flange, steel

Mounting position
NG 63 – 80 – 100 centre back

Dial
Aluminium, white,
Dial marking black

Pointer
Plastic, black

Housing
Sheet steel galvanised

Push on bezel
Sheet steel nickel-plated

Window
Version LKF: Plastic
Version LKB: Instrument glass

- Other ranges
- Other stem lengths
- Accuracy class 1
- Steel flange Ø 40/80 mm

Bimetal thermometers for industrial applications/ Bimetal air duct thermometers

Housing types and dimensions (mm)

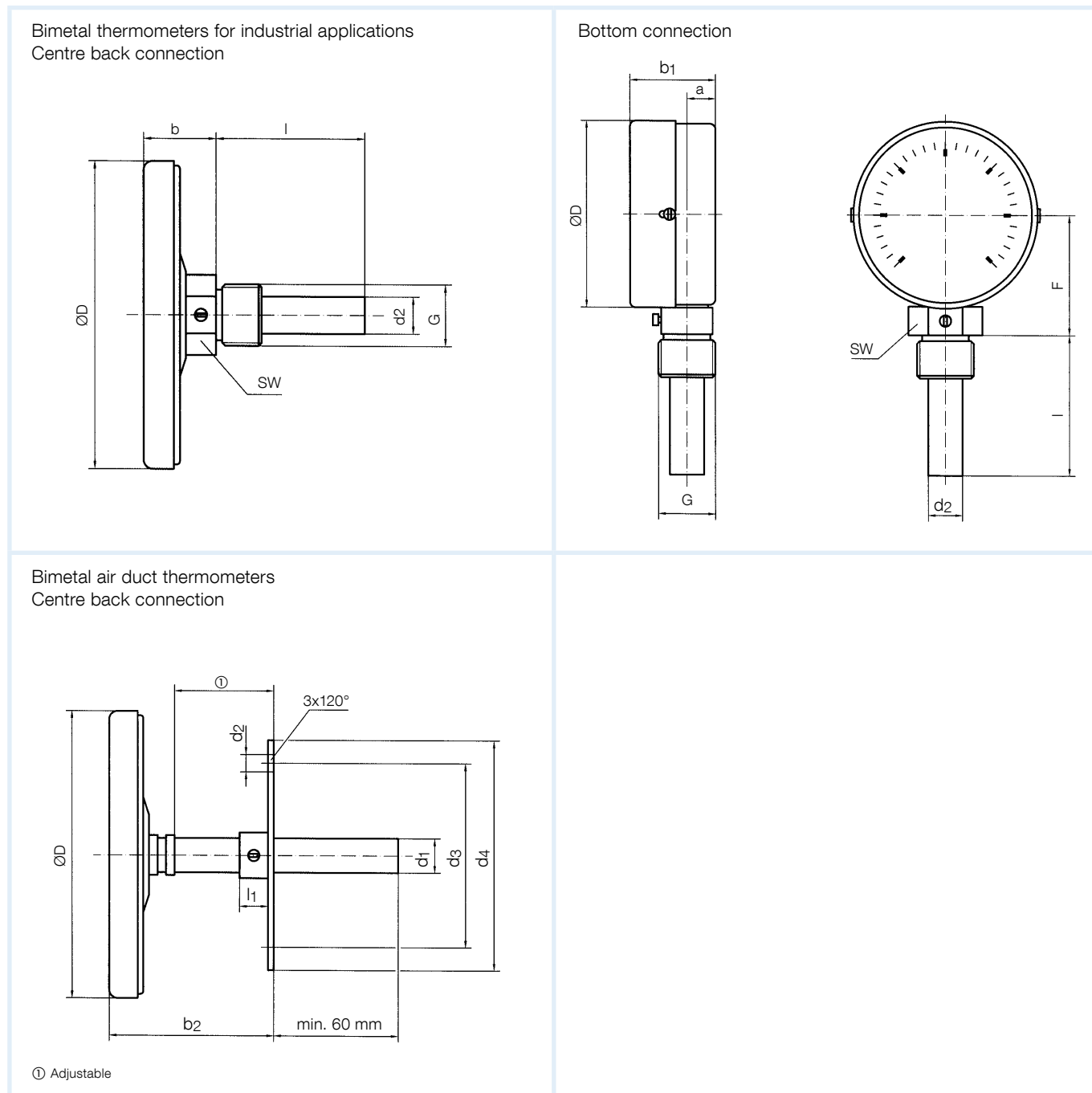

Dimensions (mm)

Nominal size (NG)	a	b	b ₁	b ₂	D	d ₁	d ₂	d ₃	d ₄	F	G	l	l ₁	SW
63	10	24	34	Adjustable	63	9	12	51	60	43,5	G½B	40	10	22
80	10	24	36		80	9	12	51	60	52	G½B	63	10	22
100	10	26	36		100	9	12	51	60	62	G½B	100	10	22
160	-	32	37		160	-	-	-	-	92	G½B	150	-	22

Bimetal thermometers for industrial applications

DG: H, PG: 2

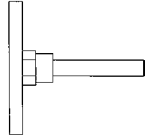
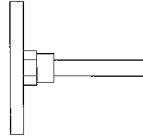
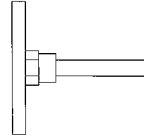
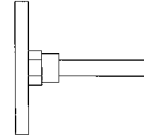
Type	BiTh 63 I D211	BiTh 80 I D211	BiTh 100 I D211	BiTh 160 I D211
Version				
Housing Ø	63	80	100	160
Housing	Sheet steel galvanised, push on bezel nickel-plated, instrument glass window			
Stem	Brass, Ø 9 mm			
Connection	Thermowell G½B, brass, Ø 12 mm outside, removable			
Accuracy class	Class 1 as per EN 13190			
Range	-20/+60 °C	-20/+60 °C	-20/+60 °C	-20/+60 °C
Stem length	Price € Part no.	Price € Part no.	Price € Part no.	Price € Part no.
40 mm	65106211	65206211	65306211	65406211
63 mm	65107211	65207211	65307211	65407211
100 mm	65108211	65208211	65308211	65408211
150 mm	65109211	65209211	65309211	65409211
Range	0/60 °C	0/60 °C	0/60 °C	0/60 °C
Stem length	Price € Part no.	Price € Part no.	Price € Part no.	Price € Part no.
40 mm	65131211	65231211	65331211	65431211
63 mm	65132211	65232211	65332211	65432211
100 mm	65133211	65233211	65333211	65433211
150 mm	65134211	65234211	65334211	65434211
Range	0/120 °C	0/120 °C	0/120 °C	0/120 °C
Stem length	Price € Part no.	Price € Part no.	Price € Part no.	Price € Part no.
40 mm	65146211	65246211	65346211	65446211
63 mm	65147211	65247211	65347211	65447211
100 mm	65148211	65248211	65348211	65448211
150 mm	65149211	65249211	65349211	65449211
Range	0/160 °C	0/160 °C	0/160 °C	0/160 °C
Stem length	Price € Part no.	Price € Part no.	Price € Part no.	Price € Part no.
40 mm	65151211	65251211	65351211	65451211
63 mm	65152211	65252211	65352211	65452211
100 mm	65153211	65253211	65353211	65453211
150 mm	65154211	65254211	65354211	65454211

Minimum order quantity for non-stock items = 10 pieces

Bimetal thermometers for industrial applications

DG: H, PG: 2

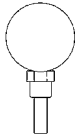
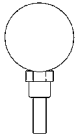
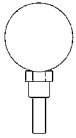
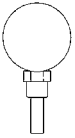
Type	BiTh 63 D201	BiTh 80 D201	BiTh 100 D201	BiTh 160 D201
Version				
Housing Ø	63	80	100	160
Housing	Sheet steel galvanised, push on bezel nickel-plated, instrument glass window			
Stem	Brass, Ø 9 mm			
Connection	Thermowell G½B, brass, Ø 12 mm outside, removable			
Accuracy class	Class 1 as per EN 13190			
Range	-20/+60 °C	-20/+60 °C	-20/+60 °C	-20/+60 °C
Stem length	Price € Part no.	Price € Part no.	Price € Part no.	Price € Part no.
40 mm	65106201	65206201	65306201	65406201
63 mm	65107201	65207201	65307201	65407201
100 mm	65108201	65208201	65308201	65408201
150 mm	65109201	65209201	65309201	65409201
Range	0/60 °C	0/60 °C	0/60 °C	0/60 °C
Stem length	Price € Part no.	Price € Part no.	Price € Part no.	Price € Part no.
40 mm	65131201	65231201	65331201	65431201
63 mm	65132201	65232201	65332201	65432201
100 mm	65133201	65233201	65333201	65433201
150 mm	65134201	65234201	65334201	65434201
Range	0/120 °C	0/120 °C	0/120 °C	0/120 °C
Stem length	Price € Part no.	Price € Part no.	Price € Part no.	Price € Part no.
40 mm	65146201	65246201	65346201	65446201
63 mm	65147201	65247201	65347201	65447201
100 mm	65148201	65248201	65348201	65448201
150 mm	65149201	65249201	65349201	65449201
Range	0/160 °C	0/160 °C	0/160 °C	0/160 °C
Stem length	Price € Part no.	Price € Part no.	Price € Part no.	Price € Part no.
40 mm	65151201	65251201	65351201	65451201
63 mm	65152201	65252201	65352201	65452201
100 mm	65153201	65253201	65353201	65453201
150 mm	65154201	65254201	65354201	65454201