

Magnetic Vibrators
MAXIMUM POWER
MINIMUM SPACE



AViTEQ Vibration Technology

WE DRIVE YOUR SUCCESS

For more than 75 years, AViTEQ Vibrationstechnik GmbH has provided oscillating conveyor solutions to almost 350,000 projects. Our extensive experience and vibrating conveyor expertise is evident with our 125 AViTEQ employees worldwide, who are always to support our international client base.

UNSHAKEABLE QUALITY

AViTEQ systems and components feature comprehensive functionalities including: conveying, sorting and dosing, screening, classifying and dewatering, compacting and loosening, cooling and heating of various bulk materials. We provide extremely varied solutions and can apply these functionalities to suit small pills and coffee beans, as well as rocks and metal pieces weighing tons.

Every bulk material has its own special requirements and AViTEQ is most likely experienced with the process, as we have designed systems and components for more than 3,600 bulk materials to date. Endurance tests performed in our technical laboratories and numerous finite element calculations ensure the highest quality of our components and systems. Experience the unshakeable quality of AViTEQ.

AViTEQ Worldwide



AVITEQ Product Portfolio

QUALIFIED PARTNER FOR SYSTEMS AND COMPONENTS

Systems

AVITEQ plans and realises vibration and process engineering solutions. Furthermore, a comprehensive offer including all-round service is made possible through AVITEQ and AEG.



Conveying technology



Screening technology

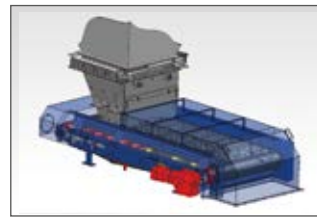

Weighing technology

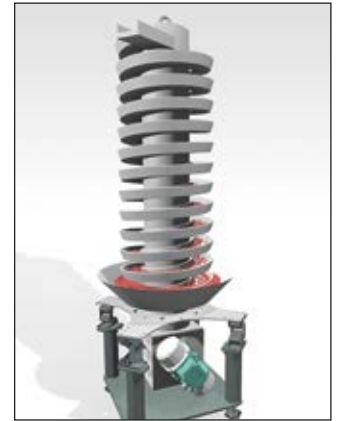

Process technology

Components

AVITEQ develops, builds and distributes drive components and control systems for vibrating conveyor systems. We also offer 24-hour replacement part support from the spare part warehouse, as well as various repair services (in-house or on-site).

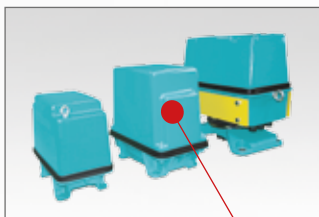

Magnetic vibrators



Unbalance motors



Parts conveyors

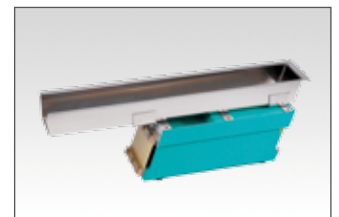

Small conveyors

MAGNETIC VIBRATORS

If you value features like infinitely variable vibration amplitudes or direct power transmission without start and stop times, you won't want to part with your AVITEQ magnetic vibrators. So it's good that you won't have to – they have an impressive service life even with a very large number of operating cycles. AVITEQ's magnetic vibrators are highly compact and ideal for:

- Conveying capacity ranging from a few kilograms to more than a thousand tonnes per hour
- ambient temperatures between -20 and +40 °C (lower and higher temperatures available as an option)
- use in the most challenging conditions. Optional extras include tropic-proof insulation, explosion protection, protection against tropical conditions, quiet operation, high bunker pressures
- performing a variety of functions to perfection: four different vibration frequencies are available for each mains frequency
- low-maintenance continuous duty, thanks to grease-free bearings, no-wear operation and high reliability.



AVITEQ Magnetic Vibrators

SUPREME MUSCLE PACKS

AVITEQ magnetic vibrators run as if they are lubricated even though they work completely grease-free. That is partly what makes them so reliable: no bearings, extremely robust design, built-in thermal switch to prevent overheating, and screw-on cable connections – great ideas that combine to deliver supreme durability and reliability.

The equipment also includes clever details such as infinitely variable vibration amplitudes, instant power transmission or flexible adaptation of drives using weight plates. The collision protection (PAL) is an easy way to optimise performance and prevent outages – another standard feature that is only provided by other manufacturers as an optional extra. Compact and strong AVITEQ magnetic vibrators have real staying power. They won't run out of steam even after years of continuous duty. An honest hard-worker.

SUPPLEMENTARY WEIGHTS

Adapted to the weight of the working equipment.

ADVANTAGES:

- drive replaceable at any time
- adaptable to different working equipment
- low storage and procurement costs

COVER

Glass fibre reinforced plastic.

ADVANTAGES:

- reliable in operation
- safe handling
- low weight
- fast installation
- effective touch protection

OVER TEMPERATURE PROTECTION

Protection against excessive temperatures in vibrators (S in type designation).

ADVANTAGE:

- protection for drive

CABLE ENTRY, TERMINAL BLOCK

Simple electrical connection at 4/6-pole terminal block; mostly preassembled cables.

ADVANTAGES:

- easier installation
- reliable in operation
- securely attached
- voltages up to 1,000 V without additional insulation

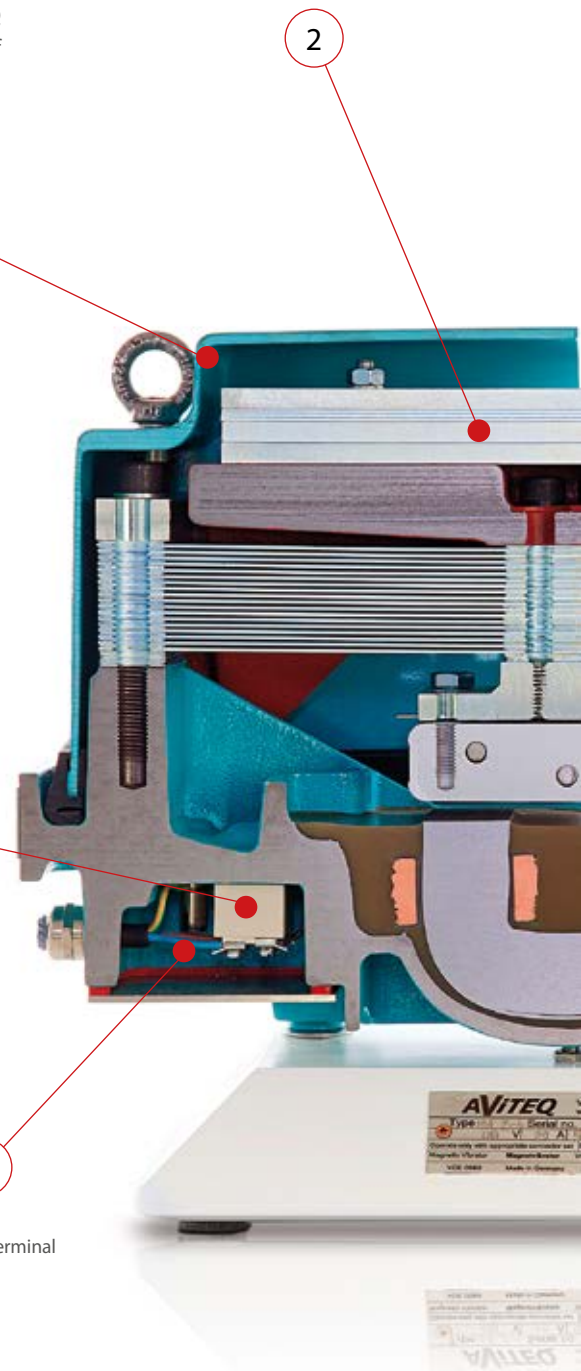

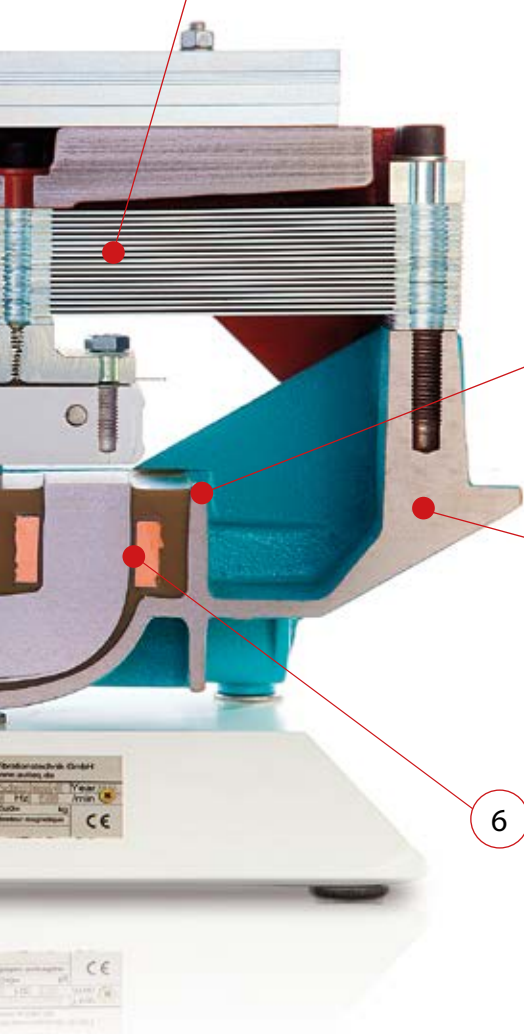

SPRING SET

Leaf springs with special surface treatment for long service life and linear vibration characteristics.

3

ADVANTAGES:

- wear-free
- low maintenance costs
- continuous operation at 100% power

4

INTERNAL VIBRATION SENSOR (PAL)

Performance optimisation up to the limit range (P in the type designation).

ADVANTAGES:

- outage protection
- performance monitoring

5

HOUSING

Multi-ribbed casing for high stresses.

ADVANTAGES:

- can be installed in any position
- reliable in operation
- long service life

6

ELECTROMAGNET

Core and winding cast in epoxy resin.

ADVANTAGES:

- reliable in operation in harsh environments
- available for potentially explosive areas
- unaffected by moisture and dust

TECHNICAL CHARACTERISTICS

Vibration frequency: 25, 33, 50, 100 Hz im 50 Hz-Netz
30, 40, 60, 120 Hz im 60 Hz-Netz

Capacity: from a few kg/h to more than a thousand t/h

Working weight: 2.5 – 1,800 kg

Mains frequency: alternating current (50 or 60 Hz)

Mains voltage: 230, 400, 500 V / 220, 380, 440, 480 V
(special voltages available on request)

Ambient temperature: -20 °C to + 40 °C
(lower and higher temperatures possible)

Standard protection*: IP 55 to DIN EN 60529

Optional: tropic-proof insulation, special coating,
external ventilation, thermal switch (on request)

* different protection with different types of magnetic vibrator

OUR SAFETY STANDARDS



Design and Choice of Motor

THREE STEPS TO THE RIGHT MAGNETIC VIBRATOR

SELECTION

1. Determine your application and the mains frequency, and obtain the vibration frequency from the bar chart.
2. In the case of drives for vibrating equipment (trough conveyors, tubular conveyors, screens, de-watering devices, helical conveyors, vibrating tables, etc.), selection is primarily based on the „working weight“. The starting point is the weight of the vibrating conveyor without the magnetic vibrator and disregarding the goods on the conveyor. In the case of bunker vibrators (external vibrators, silos, bunkers, hoppers, shake-out grids, fall pipes, filters and filling machines), we recommend that AVITEQ selects the best magnetic vibrator/impact vibrator for you.
3. Use the vibration frequency, the mains voltage and the working weight range or working weight to select the right magnetic vibrator type from the graphs below.

There is a lot of technical information available, but it is always best to get AVITEQ's help with selection. Choosing the best magnetic vibrator depends on many different factors. And that is a job for experts.



STEP ONE: YOUR APPLICATION

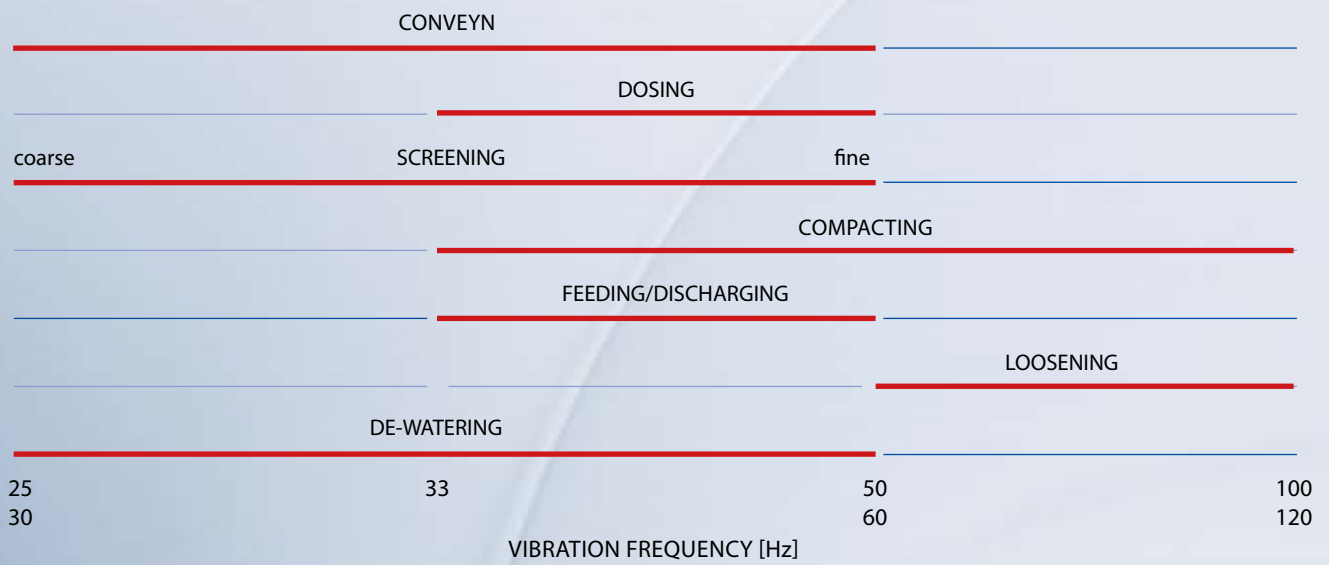

The vibration amplitudes suitable for the different application and the resulting material flow depend on the vibration amplitudes in the particular network.



PERFORMANCE GRAPHS FOR MAGNETIC VIBRATORS IN A 50 HZ NETWORK

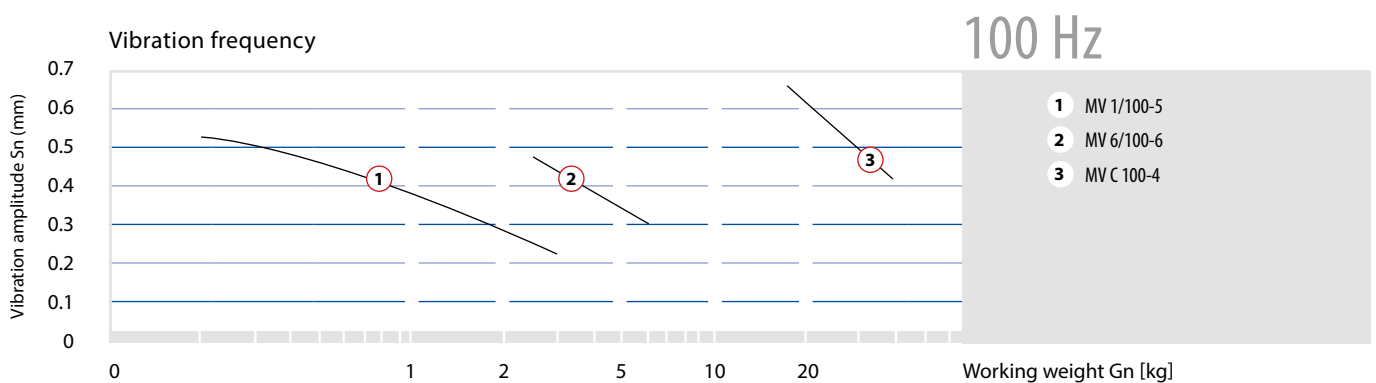
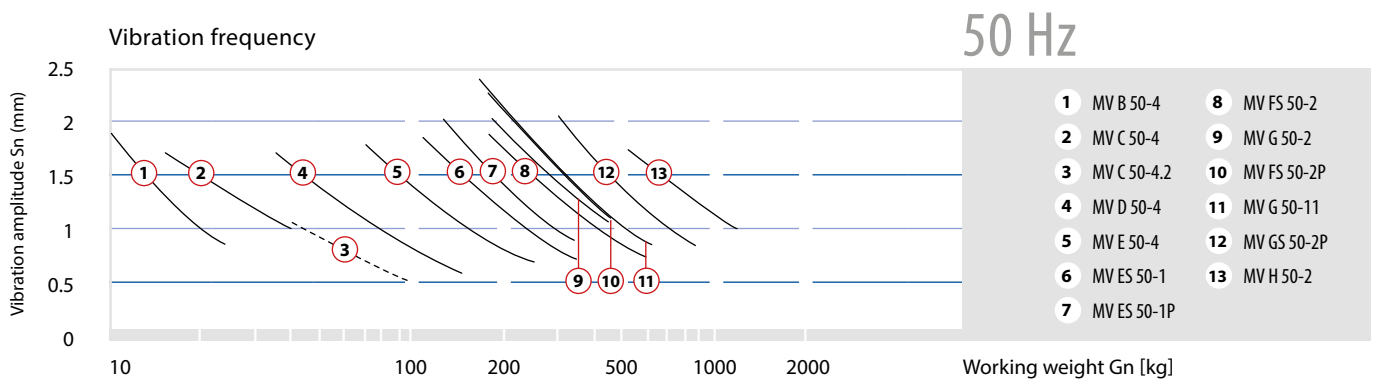
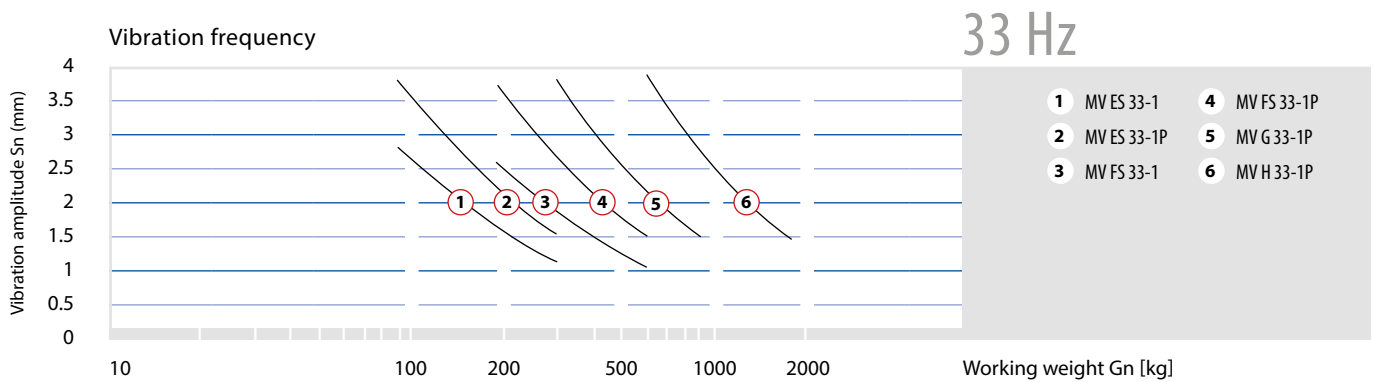
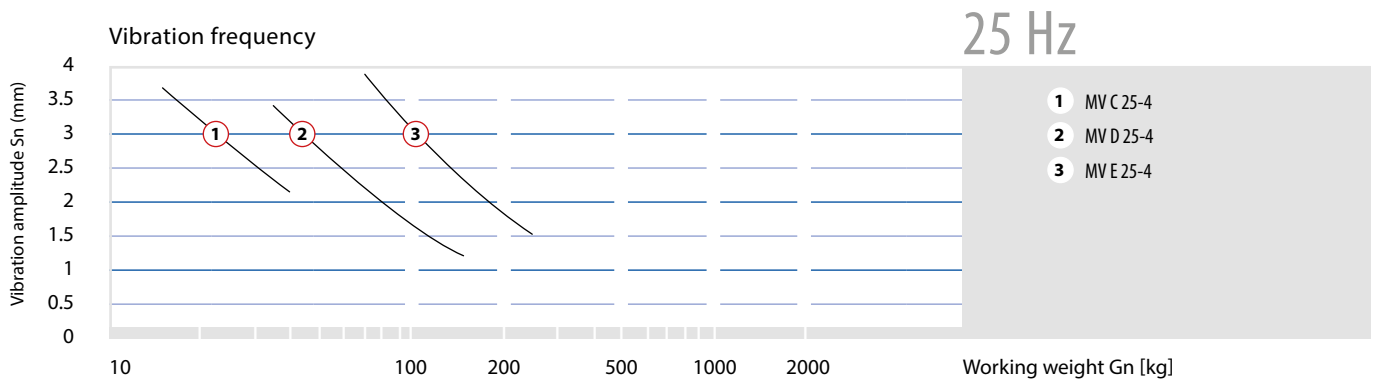

PERFORMANCE GRAPHS FOR MAGNETIC VIBRATORS IN A 60 HZ NETWORK

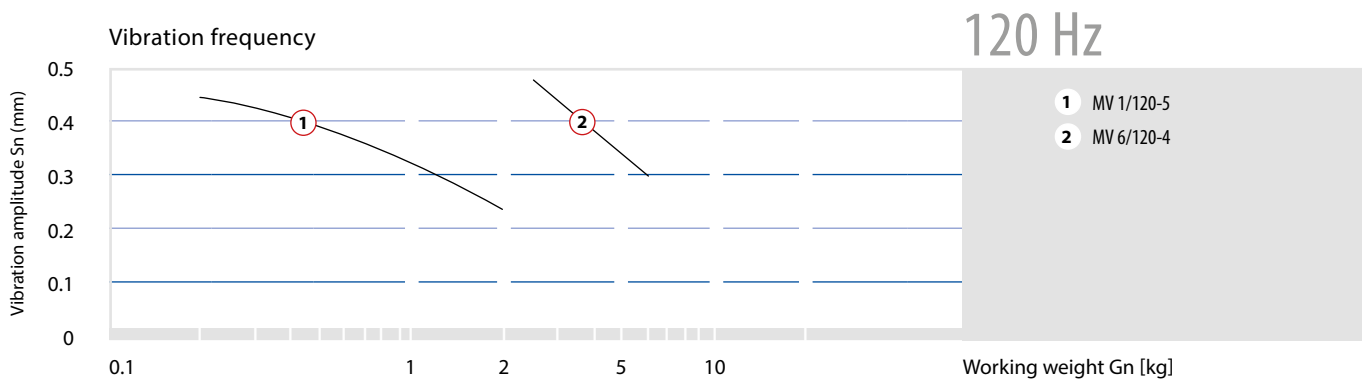
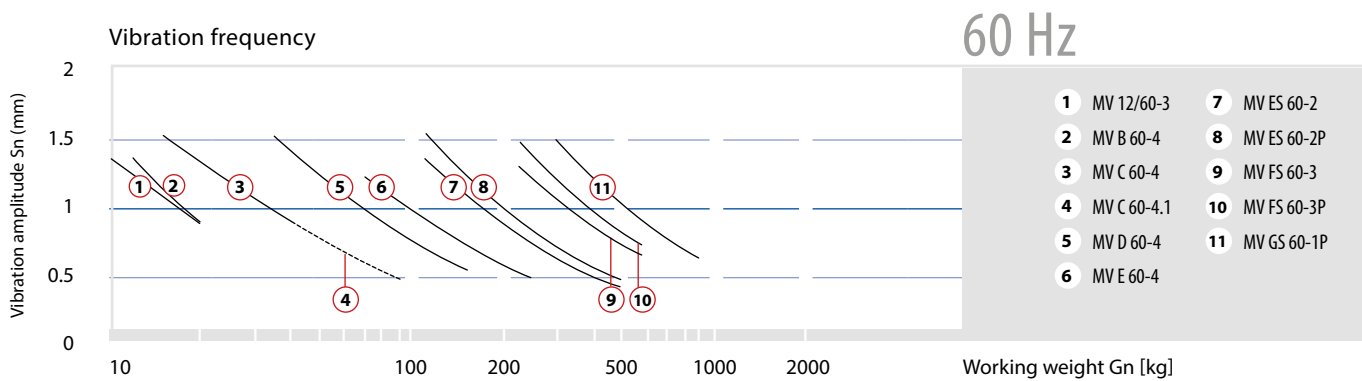
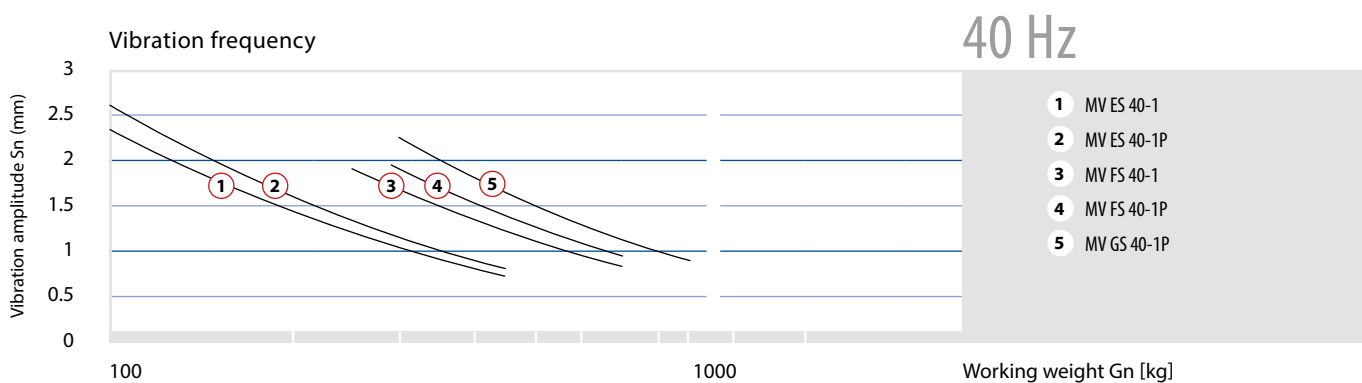
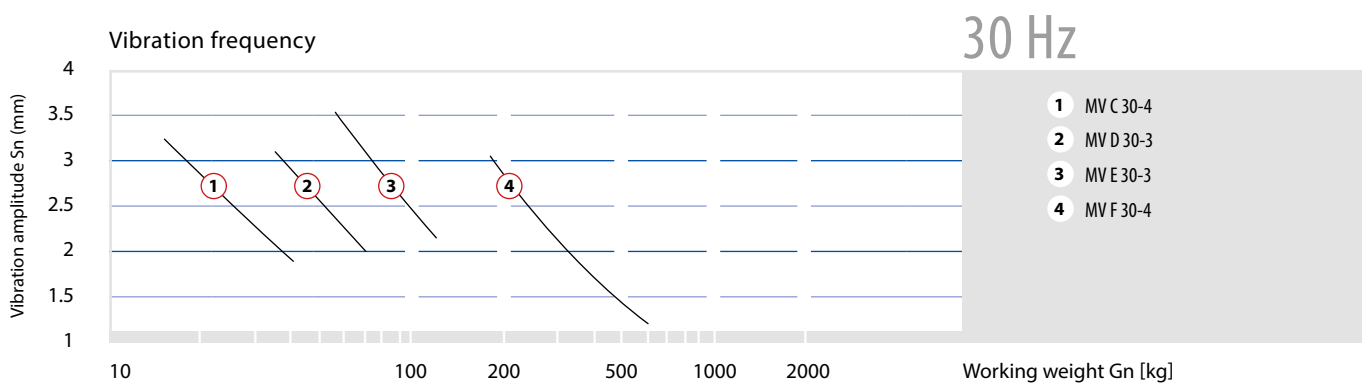

MAGNETIC VIBRATOES IN A 50 HZ NETWORK

Vibration frequency

25 Hz

Type	Mains voltage (controller input) (+/-10%)	Protection to EN 60529	Working weight range [kg]		Vibration amplitude ¹⁾ [mm]		Transport velocity ¹⁾⁺²⁾ [cm/s]		Rated current	Active power ³⁾
	[V]		from	to	from	to	from	to		
MVC25-4	220 - 240	IP 55	14	40	3.65	2.15	18	8	4.80	40
	380 - 420	IP 55	14	40	3.65	2.15	18	8	2.90	40
	480 - 520	IP 55	14	40	3.65	2.15	18	8	2.20	40
MVD25-4	220 - 240	IP 55	35	150	3.40	1.20	16	3	8.00	50
	380 - 420	IP 55	35	150	3.40	1.20	16	3	4.80	50
	480 - 520	IP 55	35	150	3.40	1.20	16	3	3.80	50
MVE25-4	220 - 240	IP 55	70	250	3.80	1.50	19	4	14.00	100
	380 - 420	IP 55	70	250	3.80	1.50	19	4	8.00	100
	480 - 520	IP 55	70	250	3.80	1.50	19	4	6.10	100

33 Hz

MVES33-1	220 - 240	IP 55	90	300	2.80	1.15	20	4	17.0	150
	380 - 420	IP 55	90	300	2.80	1.15	20	4	10.0	150
	480 - 520	IP 55	90	300	2.80	1.15	20	4	10.0	150
MVES33-1P	220 - 240	IP 55	90	300	3.80	1.55	29	7	17.0	150
	380 - 420	IP 55	90	300	3.80	1.55	29	7	10.0	150
	480 - 520	IP 55	90	300	3.80	1.55	29	7	10.0	150
MVFS33-1	380 - 420	IP 55	190	600	2.60	1.05	18	3	15.0	250
	480 - 520	IP 55	190	600	2.60	1.05	18	3	15.0	250
MVFS33-1P	380 - 420	IP 55	190	600	3.70	1.50	28	7	15.0	250
	480 - 520	IP 55	190	600	3.70	1.50	28	7	15.0	250
MVG33-1P	380 - 420	IP 55	300	900	3.80	1.50	29	7	21.0	300
	480 - 520	IP 55	300	900	3.80	1.50	29	7	17.0	300
MVH33-1P	380 - 420	IP 55	600	1800	3.80	1.50	29	7	37.5	900
	480 - 520	IP 55	600	1800	3.80	1.50	29	7	30.0	900

- + PAL integrated
- PAL not integrated

1)+2) the transport velocity values relate to a minimum acceleration of about 1.8 g and a maximum acceleration of about 9 g.

1) For operation with an AVITEQ controller.

2) Theoretical transport velocity related to a defined reference bulk material (sand) with the following parameters: material density 1.6 t/m³, grain size 3-10 mm, 8% product moisture with approximately cubic grains, 200 mm layer height, without bunker pressure, with horizontal equipment installation.

3) The specified active power refers to vibrating conveyors without the influence of the transported goods.
The active power may increase by a factor of 5 depending on the type and amount of the load.

4) PAL is a sensor integrated into the magnetic vibrator; together with an appropriate controller, it forms a closed-loop control circuit for the overall vibration amplitude, enabling performance optimisation.

All magnetic vibrators are sprayed in the standard colour RAL 5018.

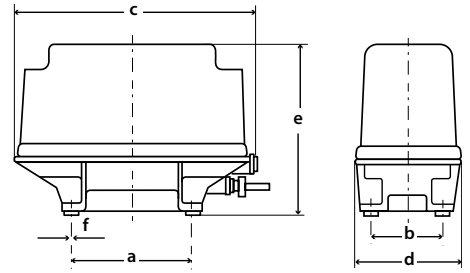

Dimensions [mm]

PAL 4)	Possible controller	Weight [kg]	a	b	c	d	e	Øf	Screws
-	BCE	42	210	125	420	180	280	11.5	M10
-	B	42	210	125	420	180	280	11.5	M10
-	B	42	210	125	420	180	280	11.5	M10
-	BCE	61	210	125	450	220	335	11.5	M10
-	BCE	61	210	125	450	220	335	11.5	M10
-	B	61	210	125	450	220	335	11.5	M10
-	BCE	110	300	190	485	255	425	18.0	M16
-	BCE	110	300	190	485	225	425	18.0	M16
-	BCE	110	300	190	485	255	425	18.0	M16
-	CE	125	300	190	540	255	425	18.0	M16
-	CE	125	300	190	540	255	425	18.0	M16
-	CE	125	300	190	540	255	425	18.0	M16
+	DF	125	300	190	540	255	425	18.0	M16
+	DF	125	300	190	540	255	425	18.0	M16
+	DF	125	300	190	540	255	425	18.0	M16
-	CE	250	350	240	640	340	545	22.0	M20
-	CE	250	350	240	640	340	545	22.0	M20
+	DF	250	350	240	640	340	545	22.0	M20
+	DF	250	350	240	640	340	545	22.0	M20
+	DF	335	500	280	860	360	690	27.0	M24
+	DF	335	500	280	860	360	690	27.0	M24
+	DF	675	420	420	901	665	710	33.0	M30
+	DF	675	420	420	901	665	710	33.0	M30

- A: Controller (Series SRA), analog, with compensation of possible mains voltage fluctuations.
 B: Controller (Series SC), analog, with compensation of possible mains voltage fluctuations.
 C: Controller (Series SA), analog, with compensation of possible mains voltage fluctuations, optional control of effective vibration amplitude with external vibration amplitude sensor (PA ...).
 D: Controller (Series SA), analog, with compensation of possible mains voltage fluctuations, control of internal overall vibration amplitude with integrated vibration amplitude sensor (PAL).
 E: Controller (Series SD), digital, with compensation of possible mains voltage fluctuations, optional control of effective vibration amplitude with external vibration amplitude sensor (PA ...) in a 50 Hz network.
 F: Controller (Series SD), digital, with compensation of possible mains voltage fluctuations, control of internal overall vibration amplitude with integrated vibration amplitude sensor (PAL) in a 50 Hz network.



MAGNETIC VIBRATOES IN A 50 HZ NETWORK

Vibration frequency

50 Hz

Type	Mains voltage (controller input) (+/-10%)	Protection to EN 60529	Working weight range [kg]		Vibration amplitude ¹⁾ [mm]		Transport velocity ¹⁾⁺²⁾ [cm/s]		Rated current	Active power ³⁾
	[V]		from	to	from	to	from	to		
MV6/50-1	220 - 240	IP 55	2.5	6	0.95	0.60	9	3	0.45	25
MV12/50-3	220 - 240	IP 55	6	18	1.85	1.00	20	10	2.4	40
MVB50-4	220 - 240	IP 15	10	24	1.80	0.85	20	7	2.0	40
MVC50-4	220 - 240	IP 55	15	40	1.70	1.00	19	10	3.5	40
	380 - 420	IP 55	15	40	1.70	1.00	19	10	2.1	40
	480 - 520	IP 55	15	40	1.70	1.00	19	10	1.6	40
MVC50-4.2	220 - 240	IP 55	40	100	1.10	0.55	12	3	3.5	40
	380 - 420	IP 55	40	100	1.10	0.55	12	3	2.1	40
	480 - 520	IP 55	40	100	1.10	0.55	12	3	1.6	40
MVD50-4	220 - 240	IP 55	35	150	1.70	0.60	19	3	6.8	50
	380 - 420	IP 55	35	150	1.70	0.60	19	3	4.0	50
	480 - 520	IP 55	35	150	1.70	0.60	19	3	2.9	50
MVE50-4	220 - 240	IP 55	70	250	1.75	0.7	20	5	12.7	100
	380 - 420	IP 55	70	250	1.75	0.7	20	5	6.8	100
	480 - 520	IP 55	70	250	1.75	0.7	20	5	5.3	100
MVES50-1	220 - 240	IP 55	100	350	1.95	0.75	20	6	18.0	150
	380 - 420	IP 55	100	350	1.95	0.75	20	6	11.0	150
	480 - 520	IP 55	100	350	1.95	0.75	20	6	11.0	150
MVES50-1P	220 - 240	IP 55	125	350	2.05	0.90	20	8	18.0	150
	380 - 420	IP 55	125	350	2.05	0.90	20	8	11.0	150
	480 - 520	IP 55	125	350	2.05	0.90	20	8	11.0	150
MVFS50-2	380 - 420	IP 55	180	600	1.9	0.75	20	6	16.0	250
	480 - 520	IP 55	180	600	1.90	0.75	20	6	16.0	250
MVFS50-2P	380 - 420	IP 55	180	600	2.25	0.90	20	8	16.0	250
	480 - 520	IP 55	180	600	2.25	0.90	20	8	16.0	250
MVG50-2	380 - 420	IP 55	180	450	2.05	1.05	20	11	21.0	300
	480 - 520	IP 55	180	450	2.05	1.05	20	11	16.0	300
MVG50-11	380 - 420	IP 25	165	450	2.35	1.10	20	12	21.0	300
	480 - 520	IP 25	165	450	2.35	1.10	20	12	16.0	300
MVG50-2P	380 - 420	IP 55	300	900	2.05	0.85	20	7	18.5	300
	480 - 520	IP 55	300	900	2.05	0.85	20	7	16.0	300
MVH50-2	380 - 420	IP 55	520	1200	1.78	1.00	20	10	41.0	900
	480 - 520	IP 55	520	1200	1.78	1.00	20	10	32.0	900

+ PAL integrated

- PAL not integrated

Legend: see pages 10/11

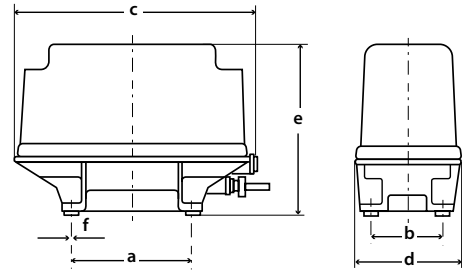

Dimensions [mm]

PAL ⁴⁾	Possible controller	Weight [kg]	a	b	c	d	e	Øf	Screws
-	A	7	240	—	265	154	140	11	M10
-	AB	18	210	125	300	200	225	11.5	M10
-	AB	14	Sidewise mounting		238	140	225	0	M10
-	AB	39	210	125	420	180	280	11.5	M10
-	B	39	210	125	420	180	280	11.5	M10
-	B	39	210	125	420	180	280	11.5	M10
-	AB	42	210	125	420	180	280	11.5	M10
-	B	42	210	125	420	180	280	11.5	M10
-	B	42	210	125	420	180	280	11.5	M10
-	BCE	63	210	125	450	220	335	11.5	M10
-	BCE	63	210	125	450	220	335	11.5	M10
-	B	63	210	125	450	220	335	11.5	M10
-	BCE	99	300	190	485	255	425	18.0	M16
-	BCE	99	300	190	485	255	425	18.0	M16
-	BCE	99	300	190	485	255	425	18.0	M16
-	CE	125	300	190	540	255	425	18.0	M16
-	BCE	125	300	190	540	255	425	18.0	M16
-	BCE	125	300	190	540	255	425	18.0	M16
+	DF	125	300	190	540	255	425	18.0	M16
+	DF	125	300	190	540	255	425	18.0	M16
+	DF	125	300	190	540	255	425	18.0	M16
-	CE	250	350	240	640	340	545	22.0	M20
-	CE	250	350	240	640	340	545	22.0	M20
+	DF	250	350	240	640	340	545	22.0	M20
+	DF	250	350	240	640	340	545	22.0	M20
-	CE	310	500	280	925	340	550	27.0	M24
-	CE	310	500	280	925	340	550	27.0	M24
-	CE	270	500	280	855	353	520	27.0	M24
-	CE	270	500	280	855	353	520	27.0	M24
+	DF	395	500	280	860	395	680	27.0	M24
+	DF	395	500	280	860	395	680	27.0	M24
-	CE	750	420	420	1000	570	665	33.0	M30
-	CE	750	420	420	1000	570	665	33.0	M30



MAGNETIC VIBRATOES IN A 50 HZ NETWORK

Vibration frequency

100 Hz

Type	Mains voltage (controller input) (+/-10%)	Protection to EN 60529	Working weight range [kg]		Vibration amplitude ¹⁾ [mm]		Transport velocity ¹⁾⁺²⁾ [cm/s]		Rated current	Active power ³⁾
	[V]		from	to	from	to	from	to		
MV1/100-5	220 - 240	IP 55	0.2	3	0.53	0.23	Impact		0.3	10
MV6/100-6	220 - 240	IP 55	2.5	6	0.47	0.30	Impact		0.7	25
MVC100-4	220 - 240	IP 55	18.0	40	0.62	0.40	12	8	3.8	40

Magnetic vibrators in Ex design (Directive 2014/34/EU (ATEX))

25 Hz

eMVC25-4-01*	220 - 240	IP65	15	40	3.65	2.15	18	8	4.8	80
	380 - 420	IP65	15	40	3.65	2.15	18	8	2.9	80
eMVD25-4-01*	220 - 240	IP65	35	150	3.40	1.20	16	3	8.0	110
	380 - 420	IP65	35	150	3.40	1.20	16	3	4.8	110
eMVE25-4-01*	380 - 420	IP65	70	250	3.80	1.50	19	4	7.5	170
	480 - 520	IP65	70	250	3.80	1.50	19	4	5.60	170

Magnetic vibrators in Ex design (Directive 2014/34/EU (ATEX))

50 Hz

eMVC50-4-01*	220 - 240	IP65	15	40	1.68	1.00	19	10	3.5	80
	380 - 420	IP65	15	40	1.68	1.00	19	10	2.1	80
eMVC50-4.2-01*	220 - 240	IP65	40	100	1.08	0.55	11	3	3.5	80
	380 - 420	IP65	40	100	1.08	0.55	11	3	2.1	80
eMVD50-4-01*	220 - 240	IP65	35	150	1.70	0.60	19	3	6.8	110
	380 - 420	IP65	35	150	1.70	0.60	19	3	4.0	110
eMVE50-4-01*	220 - 240	IP65	70	250	1.68	0.68	19	5	12.2	170
	380 - 420	IP65	70	250	1.68	0.68	19	5	6.2	170
	480 - 520	IP65	70	250	1.68	0.68	19	5	5.0	170

*Standard cable entry: M20 x 1.5 (special cable entry: ..-02: M25x1.5)

- + PAL integrated
- PAL not integrated

1)+2) the transport velocity values relate to a minimum acceleration of about 1.8 g and a maximum acceleration of about 9 g.

1) For operation with an AVITEQ controller.

2) Theoretical transport velocity related to a defined reference bulk material (sand) with the following parameters: material density 1.6 t/m³, grain size 3-10 mm, 8% product moisture with approximately cubic grains, 200 mm layer height, without bunker pressure, with horizontal equipment installation.

3) The specified active power refers to vibrating conveyors without the influence of the transported goods.
The active power may increase by a factor of 5 depending on the type and amount of the load.

4) PAL is a sensor integrated into the magnetic vibrator; together with an appropriate controller, it forms a closed-loop control circuit for the overall vibration amplitude, enabling performance optimisation.

All magnetic vibrators are sprayed in the standard colour RAL 5018.

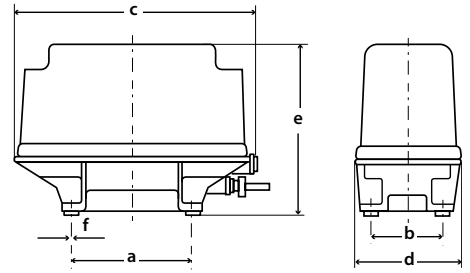

Dimensions [mm]

PAL ⁴⁾	Possible controller	Weight [kg]	a	b	c	d	e	Øf	Screws
-	A	3.1	200	—	220	124	120	9.0	M8
-	A	7	240	—	265	154	140	11.0	M10
-	A	46	210	125	420	180	280	11.5	M10
-	BCE	42	210	125	420	180	285	11.5	M10
-	B	42	210	125	420	180	285	11.5	M10
-	BCE	62	210	125	445	215	285	11.5	M10
-	BCE	62	210	125	445	215	285	11.5	M10
-	BCE	110	300	190	485	255	425	18.0	M16
-	BCE	110	300	190	485	255	425	18.0	M16
-	AB	40	210	125	420	180	285	11.5	M10
-	B	40	210	125	420	180	285	11.5	M10
-	AB	42	210	125	420	180	285	11.5	M10
-	B	42	210	125	420	180	285	11.5	M10
-	BCE	64	210	125	445	215	285	11.5	M10
-	BCE	64	210	125	445	215	285	11.5	M10
-	BCE	100	300	190	485	255	425	18.0	M16
-	BCE	100	300	190	485	255	425	18.0	M16
-	BCE	100	300	190	485	255	425	18.0	M16

A: Controller (Series SRA), analog, with compensation of possible mains voltage fluctuations.

B: Controller (Series SC), analog, with compensation of possible mains voltage fluctuations.

C: Controller (Series SA), analog, with compensation of possible mains voltage fluctuations, optional control of effective vibration amplitude with external vibration amplitude sensor (PA ...).

D: Controller (Series SA), analog, with compensation of possible mains voltage fluctuations, control of internal overall vibration amplitude with integrated vibration amplitude sensor (PAL).

E: Controller (Series SD), digital, with compensation of possible mains voltage fluctuations, optional control of effective vibration amplitude with external vibration amplitude sensor (PA ...) in a 50 Hz network.

F: Controller (Series SD), digital, with compensation of possible mains voltage fluctuations, control of internal overall vibration amplitude with integrated vibration amplitude sensor (PAL) in a 50 Hz network.



MAGNETIC VIBRATOIRES IN A 60 HZ NETWORK

Vibration frequency

30 Hz

Type	Mains voltage (controller input) (+/-10%)	Protection to EN 60529	Working weight range [kg]		Vibration amplitude ¹⁾ [mm]		Transport velocity ¹⁾⁺²⁾ [cm/s]		Rated current	Active power ³⁾
	[V]		from	to	from	to	from	to		
MVC30-4	220 - 240	IP 55	15	40	3.25	1.90	22	9	4.8	40
	440 - 480	IP 55	15	40	3.25	1.90	22	9	2.4	40
MVD30-3	220 - 240	IP 55	36	70	3.05	2.00	20	10	8.0	50
	380 - 420	IP 55	36	70	3.05	2.00	20	10	6.0	50
	440 - 480	IP 55	36	70	3.05	2.00	20	10	4.4	50
MVE30-3	220 - 240	IP 55	55	120	3.55	2.15	25	11	14.0	100
	380 - 420	IP 55	55	120	3.55	2.15	25	11	8.0	100
	440 - 480	IP 55	55	120	3.55	2.15	25	11	7.0	100
MVF30-4	380 - 420	IP 55	180	600	3.05	1.20	20	4	18.0	250
	440 - 480	IP 55	180	600	3.05	1.20	20	4	13.5	250

40 Hz

MVES40-1	380 - 420	IP 55	100	450	2.40	0.75	22	3	12.7	150
	440 - 480	IP 55	100	450	2.40	0.75	22	3	10.0	150
MVES40-1P	380 - 420	IP 55	100	450	2.65	0.80	24	3	12.7	150
	440 - 480	IP 55	100	450	2.65	0.80	24	3	10.0	150
MVF40-1	380 - 420	IP 55	250	700	1.90	0.85	16	4	15.5	250
	440 - 480	IP 55	250	700	1.90	0.85	16	4	13.5	250
MVF40-1P	380 - 420	IP 55	290	700	2.00	1.00	18	5	15.5	250
	440 - 480	IP 55	290	700	2.00	1.00	18	5	13.5	250
MVGS40-2P	440 - 480	IP 55	300	900	2.26	0.90	20	4	18.0	300

- + PAL integrated
- PAL not integrated

1)+2) the transport velocity values relate to a minimum acceleration of about 1.8 g and a maximum acceleration of about 9 g.

1) For operation with an AVITEQ controller.

2) Theoretical transport velocity related to a defined reference bulk material (sand) with the following parameters: material density 1.6 t/m³, grain size 3-10 mm, 8% product moisture with approximately cubic grains, 200 mm layer height, without bunker pressure, with horizontal equipment installation.

3) The specified active power refers to vibrating conveyors without the influence of the transported goods.

The active power may increase by a factor of 5 depending on the type and amount of the load.

4) PAL is a sensor integrated into the magnetic vibrator; together with an appropriate controller, it forms a closed-loop control circuit for the overall vibration amplitude, enabling performance optimisation.

All magnetic vibrators are sprayed in the standard colour RAL 5018.

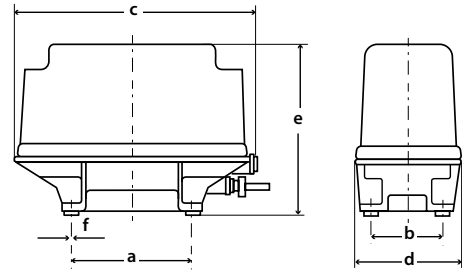

Dimensions [mm]

PAL ⁴⁾	Possible controller	Weight [kg]	a	b	c	d	e	Øf	Screws
-	BCE	40	210	125	420	180	280	11.5	M10
-	BE	40	210	125	420	180	280	11.5	M10
-	BCE	64	210	125	450	220	335	11.5	M10
-	BCE	64	210	125	450	220	335	11.5	M10
-	BCE	64	210	125	450	220	335	11.5	M10
-	BCE	124	300	190	485	255	425	18.0	M16
-	BCE	124	300	190	485	255	425	18.0	M16
-	BCE	124	300	190	485	255	425	18.0	M16
-	CE	250	350	240	640	340	545	22.0	M20
-	BCE	250	350	240	640	340	545	22.0	M20
-	CE	125	300	190	540	255	425	18.0	M16
-	CE	125	300	190	540	255	425	18.0	M16
+	D	125	300	190	540	255	425	18.0	M16
+	D	125	300	190	540	255	425	18.0	M16
-	CE	250	350	240	640	340	545	22.0	M20
-	CE	250	350	240	640	340	545	22.0	M20
+	D	250	350	240	640	340	545	22.0	M20
+	D	250	350	240	640	340	545	22.0	M20
+	D	365	500	280	860	395	690	27.0	M24

- A: Controller (Series SRA), analog, with compensation of possible mains voltage fluctuations.
 B: Controller (Series SC), analog, with compensation of possible mains voltage fluctuations.
 C: Controller (Series SA), analog, with compensation of possible mains voltage fluctuations, optional control of effective vibration amplitude with external vibration amplitude sensor (PA ...).
 D: Controller (Series SA), analog, with compensation of possible mains voltage fluctuations, control of internal overall vibration amplitude with integrated vibration amplitude sensor (PAL).
 E: Controller (Series SD), digital, with compensation of possible mains voltage fluctuations, optional control of effective vibration amplitude with external vibration amplitude sensor (PA ...) in a 50 Hz network.
 F: Controller (Series SD), digital, with compensation of possible mains voltage fluctuations, control of internal overall vibration amplitude with integrated vibration amplitude sensor (PAL) in a 50 Hz network.



MAGNETIC VIBRATOES IN A 60 HZ NETWORK

Vibration frequency

60 Hz

Type	Mains voltage (controller input) (+/-10%)	Protection to EN 60529	Working weight range [kg]		Vibration amplitude ¹⁾ [mm]		Transport velocity ¹⁾⁺²⁾ [cm/s]		Rated current	Active power ³⁾
	[V]		from	to	from	to	from	to		
MV12/60-3	220 - 240	IP 55	10	20	1.40	0.90	16	11	2.70	40
MVB60-4	220 - 240	IP 15	12	20	1.38	0.90	16	11	2.00	40
MVC60-4	220 - 240	IP 55	15	40	1.55	0.90	16	11	3.80	40
	380 - 420	IP 55	15	40	1.55	0.90	16	11	2.20	40
	440 - 480	IP 55	15	40	1.55	0.90	16	11	1.90	40
MVC60-4.1	220 - 240	IP 55	40	100	0.90	0.45	11	3	3.80	40
	380 - 420	IP 55	40	100	0.90	0.45	11	3	2.20	40
	440 - 480	IP 55	40	100	0.90	0.45	11	3	1.90	40
MVD60-4	220 - 240	IP 55	35	150	1.55	0.55	16	4	6.80	50
	380 - 420	IP 55	35	150	1.55	0.55	16	4	4.10	50
	440 - 480	IP 55	35	150	1.55	0.55	16	4	4.00	50
MVE60-4	220 - 240	IP 55	70	250	1.25	0.50	16	3	11.4	100
	380 - 420	IP 55	70	250	1.25	0.50	16	3	6.80	100
	440 - 480	IP 55	70	250	1.25	0.50	16	3	5.80	100
MVES60-2	220 - 240	IP 55	110	500	1.38	0.40	16	2	18.0	150
	380 - 420	IP 55	110	500	1.38	0.40	16	2	9.50	150
	440 - 480	IP 55	110	500	1.38	0.40	16	2	8.00	150
MVES60-2P	220 - 240	IP 55	110	500	1.57	0.47	16	3	18.0	150
	380 - 420	IP 55	110	500	1.57	0.47	16	3	9.50	150
	440 - 480	IP 55	110	500	1.57	0.47	16	3	8.00	150
MVFS60-3	380 - 420	IP 55	210	600	1.36	0.60	16	5	13.5	250
	440 - 480	IP 55	210	600	1.36	0.60	16	5	11.5	250
MVFS60-3P	380 - 420	IP 55	220	600	1.48	0.68	16	5	13.5	250
	440 - 480	IP 55	220	600	1.48	0.68	16	5	11.5	250
MVGS60-1P	440 - 480	IP55	300	900	1.45	0.62	16	5	18.0	300

- + PAL integrated
- PAL not integrated

1)+2) the transport velocity values relate to a minimum acceleration of about 1.8 g and a maximum acceleration of about 9 g.

1) For operation with an AVITEQ controller.

2) Theoretical transport velocity related to a defined reference bulk material (sand) with the following parameters: material density 1.6 t/m³, grain size 3-10 mm, 8% product moisture with approximately cubic grains, 200 mm layer height, without bunker pressure, with horizontal equipment installation.

3) The specified active power refers to vibrating conveyors without the influence of the transported goods.
The active power may increase by a factor of 5 depending on the type and amount of the load.

4) PAL is a sensor integrated into the magnetic vibrator; together with an appropriate controller, it forms a closed-loop control circuit for the overall vibration amplitude, enabling performance optimisation.

All magnetic vibrators are sprayed in the standard colour RAL 5018.

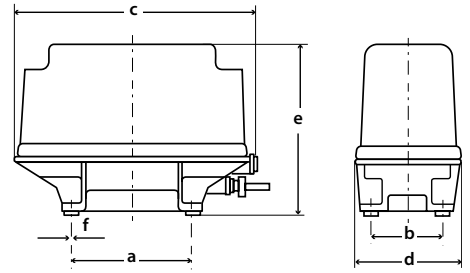

Dimensions [mm]

PAL ⁴⁾	Possible controller	Weight [kg]	a	b	c	d	e	Øf	Screws
-	AB	18	210	125	300	200	225	11.5	M10
-	AB	17	Sidewise mounting		238	140	231		M10
-	ABE	41	210	125	420	180	280	11.5	M10
-	BE	41	210	125	420	180	280	11.5	M10
-	BE	41	210	125	420	180	280	11.5	M10
-	ABE	45	210	125	420	180	280	11.5	M10
-	BE	45	210	125	420	180	280	11.5	M10
-	BE	45	210	125	420	180	280	11.5	M10
-	BCE	60	210	125	450	220	335	11.5	M10
-	BCE	60	210	125	450	220	335	11.5	M10
-	BCE	60	210	125	450	220	335	11.5	M10
-	BCE	98	300	190	485	255	425	18.0	M16
-	BCE	98	300	190	485	255	425	18.0	M16
-	BCE	98	300	190	485	255	425	18.0	M16
-	CE	125	300	190	540	255	425	18.0	M16
-	BCE	125	300	190	540	255	425	18.0	M16
-	BCE	125	300	190	540	255	425	18.0	M16
+	D	125	300	190	540	255	425	18.0	M16
+	D	125	300	190	540	255	425	18.0	M16
+	D	125	300	190	540	255	425	18.0	M16
-	BCE	250	350	240	640	340	545	22.0	M20
-	BCE	250	350	240	640	340	545	22.0	M20
+	D	250	350	240	640	340	545	22.0	M20
+	D	250	350	240	640	340	545	22.0	M20
+	D	415	500	280	860	395	680	27.0	M24

- A: Controller (Series SRA), analog, with compensation of possible mains voltage fluctuations.
 B: Controller (Series SC), analog, with compensation of possible mains voltage fluctuations.
 C: Controller (Series SA), analog, with compensation of possible mains voltage fluctuations, optional control of effective vibration amplitude with external vibration amplitude sensor (PA ...).
 D: Controller (Series SA), analog, with compensation of possible mains voltage fluctuations, control of internal overall vibration amplitude with integrated vibration amplitude sensor (PAL).
 E: Controller (Series SD), digital, with compensation of possible mains voltage fluctuations, optional control of effective vibration amplitude with external vibration amplitude sensor (PA ...) in a 50 Hz network.
 F: Controller (Series SD), digital, with compensation of possible mains voltage fluctuations, control of internal overall vibration amplitude with integrated vibration amplitude sensor (PAL) in a 50 Hz network.



MAGNETIC VIBRATOIRES IN A 60 HZ NETWORK

Vibration frequency

120 Hz

Type	Mains voltage (controller input) (+/-10%)	Protection to EN 60529	Working weight range [kg]		Vibration amplitude ¹⁾ [mm]		Transport velocity ¹⁾⁺²⁾ [cm/s]		Rated current	Active power ³⁾
	[V]		from	to	from	to	from	to		
MV1/120-5	220 - 240	IP 55	0.2	2	0.45	0.25	Impact		0.29	10
MV6/120-4	220 - 240	IP 55	2.5	6	0.47	0.30	Impact		0.6	25

Magnetic vibrators in Ex design (Directive 2014/34/EU (ATEX))

60 Hz

eMVC60-4-01*	220 - 240	IP65	15	40	1.48	0.85	16	10	3.8	80
	440 - 480	IP65	15	40	1.48	0.85	16	10	1.8	80

*Standard cable entry: M20x1.5 (special cable entry: ..-02: M25x1.5)

- + PAL integrated
- PAL not integrated

1)+2) the transport velocity values relate to a minimum acceleration of about 1.8 g and a maximum acceleration of about 9 g.

1) For operation with an AVITEQ controller.

2) Theoretical transport velocity related to a defined reference bulk material (sand) with the following parameters: material density 1.6 t/m³, grain size 3-10 mm, 8% product moisture with approximately cubic grains, 200 mm layer height, without bunker pressure, with horizontal equipment installation.

3) The specified active power refers to vibrating conveyors without the influence of the transported goods.

The active power may increase by a factor of 5 depending on the type and amount of the load.

4) PAL is a sensor integrated into the magnetic vibrator; together with an appropriate controller, it forms a closed-loop control circuit for the overall vibration amplitude, enabling performance optimisation.

All magnetic vibrators are sprayed in the standard colour RAL 5018.

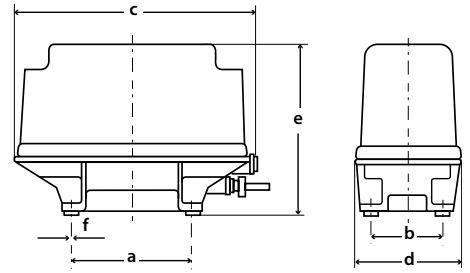

Dimensions [mm]

PAL ⁴⁾	Possible controller	Weight [kg]	a	b	c	d	e	Øf	Screws
-	A	3.1	200	—	220	124	120	9.0	M8
-	A	7	240	—	265	154	140	11.0	M10
-	AB	42	210	125	420	180	285	11.5	M10
-	B	42	210	125	420	180	285	11.5	M10

- A: Controller (Series SRA), analog, with compensation of possible mains voltage fluctuations.
- B: Controller (Series SC), analog, with compensation of possible mains voltage fluctuations.
- C: Controller (Series SA), analog, with compensation of possible mains voltage fluctuations, optional control of effective vibration amplitude with external vibration amplitude sensor (PA ...).
- D: Controller (Series SA), analog, with compensation of possible mains voltage fluctuations, control of internal overall vibration amplitude with integrated vibration amplitude sensor (PAL).
- E: Controller (Series SD), digital, with compensation of possible mains voltage fluctuations, optional control of effective vibration amplitude with external vibration amplitude sensor (PA ...) in a 50 Hz network.
- F: Controller (Series SD), digital, with compensation of possible mains voltage fluctuations, control of internal overall vibration amplitude with integrated vibration amplitude sensor (PAL) in a 50 Hz network.



Controllers

KEEPING EVERYTHING IN TIME

To keep your drives running longer, AVITEQ has a full range of controllers. These intelligent clocks are not just suitable for our own components – they also work perfectly with drives from other manufacturers. Even though the standard controllers are highly versatile, they can be optimised for special applications with a range of optional equipment.

In the type designation, all open frame controllers are identified with (E). All other controllers have housings.



SRA(E)

Voltage-controlled controllers designed for current consumption up to 6.0 A and for soft starts.

Mains voltage fluctuations are compensated and have almost no effect on transporting performance.

Controllers of type SRA/SRAE are also available with optional level scanning/part overflow control. These controllers are specially designed to link multiple vibrating conveyors.



SC(E)

Voltage-controlled controllers designed for current consumption up to 15.0 A and for soft starts.

Mains voltage fluctuations are compensated and have almost no effect on transporting performance.

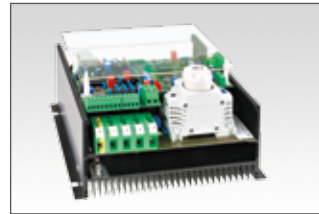

SA(E)

Voltage-controlled controllers designed for current consumption up to 43.0 A and for soft starts.

Mains voltage fluctuations are compensated and have almost no effect on transporting performance.



SD(E)

Voltage-controlled controllers designed for current consumption up to 100.0 A and for soft starts. This controller type is equipped with a digital control unit.

Mains voltage fluctuations are compensated and have almost no effect on transporting performance.

Controllers

CONNECTIONS AND COMMISSIONING

Characteristics	SRA(E)...	SC(E)...	SA(E)...	SD(E)...
Vibrator current, maximum	6 A	15 A	25 or 43 A	25, 50 or 100 A
Mains voltage in 50/60 Hz networks	105...115 V	220...240 V	220...240 V ¹⁾	220...240 V ¹⁾
Special voltages available on request	220...240 V	380...420 V	380...420 V	380...420 V
		440...480 V	440...480 V	440...480 V
		500...520 V	460...500 V	480...520 V
Vibration frequency in 50 Hz network	50 or 100 Hz	25 or 50 Hz	25, 33 or 50 Hz	25, 33 or 50 Hz
Vibration frequency in 60 Hz network	60 or 120 Hz	30 or 60 Hz	30, 40 or 60 Hz	30, 40 or 60 Hz
Signal processing	analog	analog	analog	digital
Voltage control	+	+	+	+
Vibration amplitude control with collision monitoring			+	
Limiting control with collision monitoring				+
Vibration amplitude control			+	+
Temperature monitoring for magnetic vibrator directly connectable			+	+
External reference variables directly connectable (0-10 V DC; 4-20 mA or 0-20 mA)	+	+	+	+
Set value switchable between potentiometer (local) and external reference variable	(+) ²⁾	+	+	+
Vibration amplitude approximately proportional to setpoint	+	+	+	+
External actual value display connectable			+	+
Enable (switch on/off) via	Switch	Switch	Switch	Switch
	Opto-coupler	Opto-coupler	Button	Button
	Voltage signal +24 V DC	Voltage signal +24 V DC	Opto-coupler	Opto-coupler
Integrated status relay	1 relay	1 relay	1 relay	2 relays
Display of operating status via	Illuminated power switch	2 LEDs	7 LEDs	2 LEDs and 4-digit display
Actual value output Maximum value at maximum vibration amplitude			+ 10.0 V DC	+ 8.0 V DC ³⁾ +10.0 V DC
Master/Slave integrated (for multiple drive)				+
Reversing mode integrated				+
Power supply output			+ 5.0 V DC	+ 5.0 V DC
Configuration adjustable with	Trimmer	Trimmer	Trimmer	
	Jumper		Dip switch	Keypad
Operating data for multiple AVITEQ magnetic vibrators stored and selectable				+
Open frame version (E), height x width x depth [mm]	125x112x102	200x62x190	200x230x140	388x150x350
Version with housing (standard), height x width x depth [mm]	170x120x92	300x300x210	300x380x155 (25A) 380x380x210 (43A)	600x380x350

+ integrated

1) 25 A Version

2) Only possible for 0-10 V DC

3) Adjustable via software. In addition, for voltages, the lower limit can be increased via software from 0 to +2.0 V



Made by AViTEQ IN DEMAND WORLDWIDE



We are there for you, around the world, and in over 30 countries locally. Talk to us, become a customer, and find out exactly what quality and service Made by AViTEQ means. We always keep our contact information up-to-date for you at:

● www.aviteq.com ●



AViTEQ Vibrationstechnik GmbH

Im Gotthelf 16
D-65795 Hattersheim

Tel.: +49 (0) 6145 503-0
Fax: +49 (0) 6145 503-200
eMail: info@aviteq.de
www.aviteq.com