

# Dial-Air™ Regulator Numbering System

   = "Most Popular"

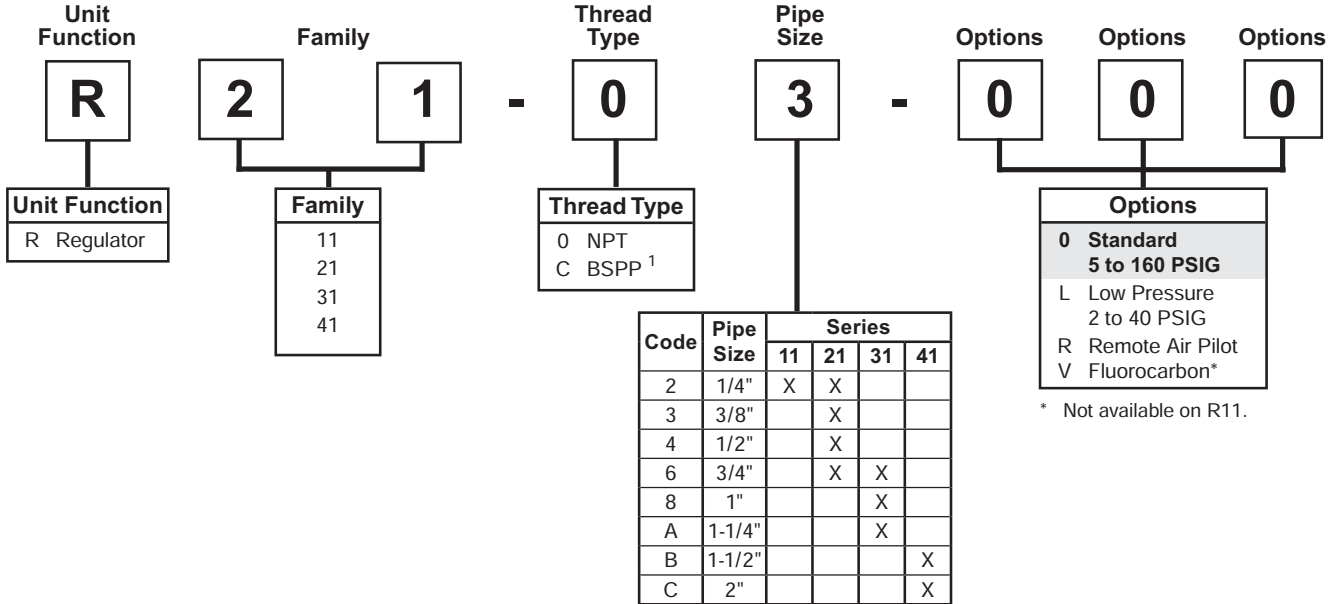

**B**

<sup>1</sup> ISO, R228 (G Series)

**NOTE:** Standard pressure adjustment is plastic "snap lock" knob and plastic bonnet with plastic panel mount nut.

**NOTE:** When selecting from the options columns, please enter letters in alphabetical order for positions 6, 7, and 8. For example:

**R21 - 0 3 - 0 0 0**

# Dial-Air™ Regulator

## R21

 = "Most Popular"

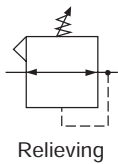

**R21-02-000**

### Features

- Balanced Valve Design
- Non-Rising Pressure Adjusting Dial
- High-Relief Flow (3/16" Relief Orifice)
- Two 1/4" NPT Gauge Ports, Usually Used for Additional Outlets
- Piston Operated

### Specifications

Flow Capacity*	1/4	117 SCFM (55 dm <sup>3</sup> /s)
	3/8	180 SCFM (85 dm <sup>3</sup> /s)
	1/2	195 SCFM (92 dm <sup>3</sup> /s)
	3/4	220 SCFM (103 dm <sup>3</sup> /s)
Adjusting Range Pressure	0 to 40 PSIG (0 to 2.8 bar)	
	0 to 160 PSIG (0 to 11 bar)	
Bleed Rate	0.05 SCFM (0.024 dm <sup>3</sup> /s)	
Gauge Port (2 ea.)	NPT / BSPT-Rc	1/4
Maximum Supply Pressure	300 PSIG (20.7 bar)	
Operating Temperature	32° to 150°F (0° to 65.5°C)	
Port Size	NPT / BSPP-G	1/4, 3/8, 1/2, 3/4
Weight	lb. (kg)	2.3 (1.04)

\* Inlet pressure 100 PSIG (6.9 bar). Secondary pressure (1/4, 1/2 & 3/4) 90 PSIG (6.2 bar); (3/8) 80 PSIG (5.5 bar).

### Materials of Construction

Body	Zinc
Bonnet	Zinc / Brass
Piston	Acetal
Seals	Nitrile
Springs	Steel
Valve Assembly	Brass / Nitrile / Acetal

### WARNING

**Product rupture can cause serious injury.  
Do not connect regulator to bottled gas.  
Do not exceed maximum primary pressure rating.**

### CAUTION:

**REGULATOR PRESSURE ADJUSTMENT** – The working range of knob adjustment is designed to permit outlet pressures within their full range. Pressure adjustment beyond this range is also possible because the knob is not a limiting device. This is a common characteristic of most industrial regulators, and limiting devices may be obtained only by special design.

For best performance, regulated pressure should always be set by increasing the pressure up to the desired setting.

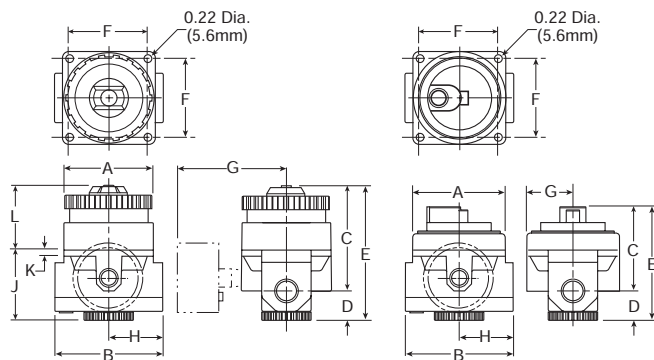

**Remote Operated**

**NOTE:** Panel mounting requires (2) 11/16" (69mm) diameter holes and (4) 7/32" (5.5mm) screw holes. Unit can be mounted on material up to 1-1/4" (32mm) thick.

### Dimensions

Models	Inches (mm)	A	B	C	D	E	F	G	H	J	K	L
Standard Unit R21-XX-000		2.60 (66)	3.19 (81)	3.14 (79.8)	.95 (24)	4.09 (104)	2.20 (55.9)	— —	1.61 (41)	2.08 (52.8)	.18 (4.6)	2.07 (52.6)
With Gauge (order separately) R21-XX-XXX		2.60 (66)	3.19 (81)	3.14 (79.8)	.95 (24)	4.09 (104)	2.20 (55.9)	2.70 (68.5)	1.61 (41)	2.08 (52.8)	.18 (4.6)	2.07 (52.6)
Remote Operated R21-XX-R00		2.60 (66)	3.19 (81)	2.24 (56.9)	.95 (24)	3.19 (81)	2.20 (55.9)	1.33 (33.8)	1.61 (41)	2.08 (52.8)	.18 (4.6)	1.11 (28.2)

= "Most Popular"

### Replacement Kits

- Adjustment Dial Knob ..... RRP-16-024-000
- Conversion Kit (Series A to Series B) ..... RRP-95-766
- Cover Kit (Remote) –
  - Bonnet and Nitrile, O-ring (Series B) ..... RRP-95-910
  - Bonnet and Fluorocarbon, O-ring (Series B) ..... RRP-95-911
- O-ring, Repair Kit ..... GRP-95-260
- Piston, Bottom and O-ring Seal ..... RRP-95-192
- Spring, Regulating, Belleville Washer –
  - 2 to 40 PSIG (0.1 to 3 bar) ..... RRP-95-906
  - 5 to 160 PSIG (0.4 to 11 bar) ..... RRP-95-905
- Valve, Main with U-cup Seal ..... RRP-95-151
- Valve, Main with U-cup Seal and Bottom Plug –
  - Nitrile Elastomers ..... RRP-95-914
  - Fluorocarbon Elastomers ..... RRP-95-915
- Valve, Main (Remote) with U-cup Seal ..... RRP-96-952

- Valve, Main (Remote) with U-cup Seal and Bottom Plug –
  - Nitrile Elastomers ..... RRP-95-912
  - Fluorocarbon Elastomers ..... RRP-95-913
- Valve, Pilot with O-ring and Valve Spring ..... RRP-96-934

### Accessories

- Wall Mounting Bracket, Gauge Port Adapter,
  - 1/4 NPT ..... RRP-95-590
- Gauge, Pressure –
  - 0 to 60 PSIG (0 to 4 bar), 2" Dial Face,
    - 1/4 NPT, CBM ..... K4520N14060
  - 0 to 160 PSIG (0 to 11 bar), 2" Dial Face,
    - 1/4 NPT, CBM ..... K4520N14160
- Tamper Resistant Kit ..... RRP-95-585

**B**

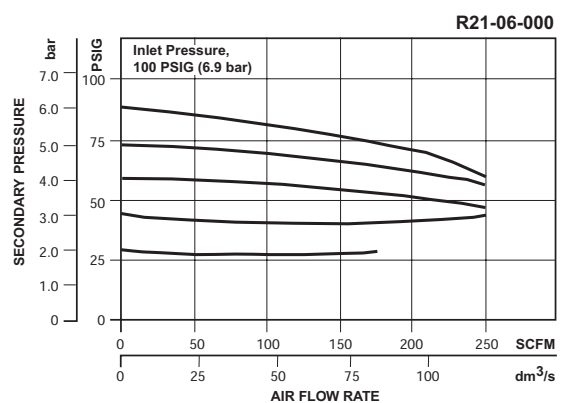
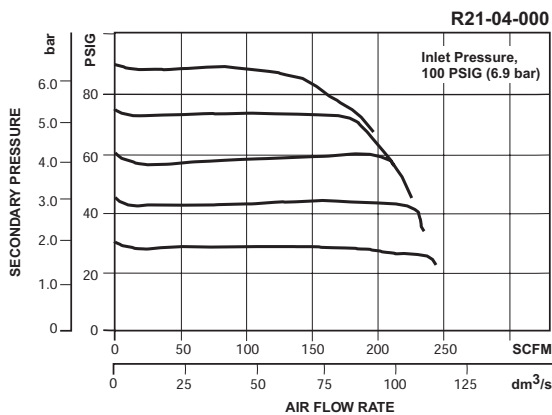
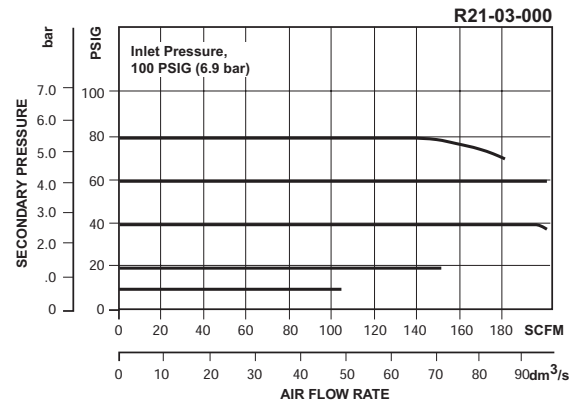
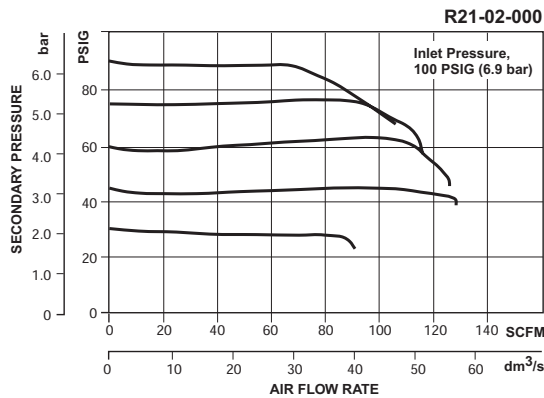

### Ordering Information

Model Type	Port Size	High Flow 5 to 160 PSIG (0.4 to 11 bar)	Low Pressure 2 to 40 PSIG (0.1 to 3 bar)	Remote 5 to 160 PSIG (0.4 to 11 bar)
Relieving	1/4	R21-02-000	R21-02-L00	R21-02-R00
	3/8	R21-03-000	R21-03-L00	R21-03-R00
	1/2	R21-04-000	R21-04-L00	R21-04-R00
	3/4	R21-06-000	R21-06-L00	R21-06-R00

Options - To order an option supplied with the unit model, add the appropriate coded suffix letter in the designated position of the model number.