

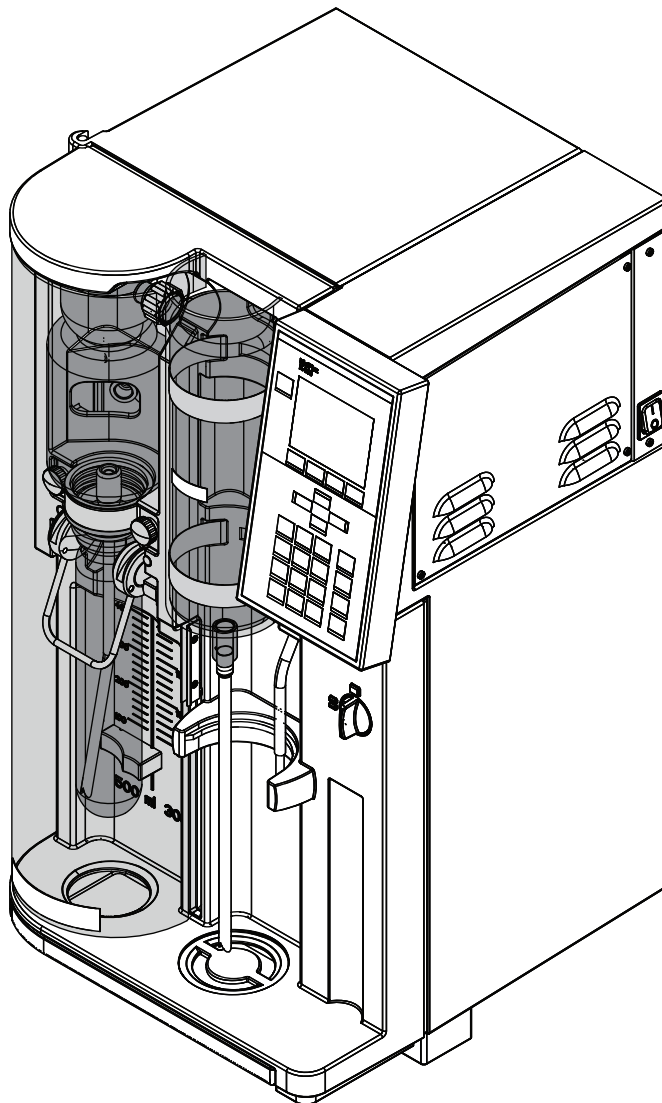

# KjelFlex K-360

## Technical data sheet

Modular distillation unit for a wide range of applications requiring steam distillation. The instrument can be configured to fulfill various requirements and can be upgraded if needs change.



## Modular instrument setup

Due to its modular concept the KjellFlex K-360 can be adapted to any need. The choice of glass or plastic splash protector, acid resistant pump and titration set allows to match different requirements. The distillation unit is compatible with a wide selection of titration units to guarantee smooth and trouble-free operation.

All instrument versions are supplied ready to use and comprise a steam generator, pumps for dosage of alkali, boric acid and water as well as the aspiration of sample tube and receiver residues.

### A) Two splash protector types

The splash protector is crucial to obtain accurate results. Two types are available: Glass or glass-fibre reinforced polypropylene splash protector (referred to as "plastic").

Advantage of the glass splash protector:

- visual monitoring of the distillation process makes method development more convenient

Advantage of the plastic splash protector:

- increased durability to sodium hydroxide extends the lifetime of the protector

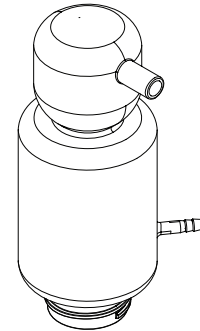

### B) Acid resistant pump for an extended application range

Besides the classical Kjeldahl, TKN or Devarda applications, the K-360 can be used for additional steam distillations. Especially analysis of samples requiring the dosing of strong acids can be carried out conveniently.

Additional applications:

- sulphur dioxide
- phenol
- formaldehyde

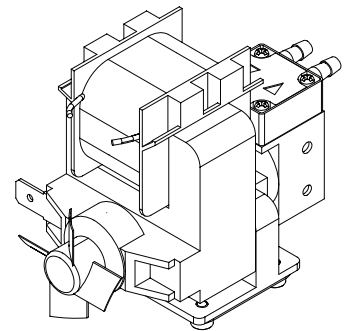

### C) Titration set to automate the analysis process

The titration set is needed to connect an external titrator. This configuration increases the level of automation and enables higher sample throughput.

Titration sets recommended with the K-360:

- Metrohm (702, 719, 785, Titrino Plus 877/848, 916 TiTouch)
- Mettler-Toledo (DL15, DL22, T50, Excellence Line, G10S/G20S)
- Radiometer (TitraLab 840)
- Schott/SI Analytics (TitroLine Easy, TitroLine 5000)

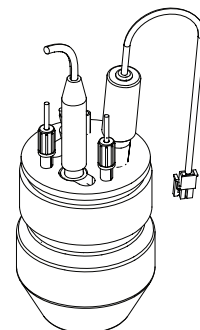

## Scope of delivery KjelFlex K-360

All configurations are supplied ready to use.

Component	K-360
KjelFlex K-360	1
Splash protector **	1
Titration set **	1
Power cable	1
Operation Manual	1
Sample tube (300 mL)	1
Storage tanks (10 L)	3
Hose for chemical feed (6 m)	1
Hose for cooling water feed (1.5 m)	1
Hose for cooling water drain (1.8 m)	1
Hose for cooling water drain (1.8 m)	1
Pair of glass tongs	1

\*\* According to order code

## Order Code

Choose the configuration according to your needs:

0 4 3 6 0

KjelFlex K-360

- 0 Splash protector glass
- 1 Splash protector plastic
- 4 Splash protector plastic, acid pump
- 5 Splash protector glass, acid pump
- 6 Splash protector plastic, titration set
- 7 Splash protector glass, titration set
- 8 Splash protector plastic, acid pump, titration set
- 9 Splash protector glass, acid pump, titration set

## Scope of delivery KjellFlex K-360 with splash protector glass and titration set

All configurations are supplied ready to use.

Component	K-360
KjellFlex K-360	1
Splash protector glass	1
Titration Metrohm Titrino plus 877 (11055703)	1
Cable for Metrohm Titrino plus (11055333)	1
Power cable	1
Operation Manual	1
Sample tube (300 mL)	1
Storage tanks (10 L)	3
Hose for chemical feed (6 m)	1
Hose for cooling water feed (1.5 m)	1
Hose for cooling water drain (1.8 m)	1
Hose for cooling water drain (1.8 m)	1
Pair of glass tongs	1

## Order Code

1 1 0 6 4 9 6 4

## Scope of delivery KjelFlex K-360 with splash protector plastic and titration set

All configurations are supplied ready to use.

Component	K-360
KjelFlex K-360	1
Splash protector plastic	1
Titration Metrohm Titrino plus 877 (11055703)	1
Cable for Metrohm Titrino plus (11055333)	1
Power cable	1
Operation Manual	1
Sample tube (300 mL)	1
Storage tanks (10 L)	3
Hose for chemical feed (6 m)	1
Hose for cooling water feed (1.5 m)	1
Hose for cooling water drain (1.8 m)	1
Hose for cooling water drain (1.8 m)	1
Pair of glass tongs	1

## Order Code

1 1 0 6 4 9 6 5

## Technical data

### KjelFlex

#### K-360

Dimensions (W x D x H)	405 x 400 x 660 mm
Weight	22 kg
Display	LC display, monochrome
Memory	50 methods 500 results
Password protection	Yes
Language	DE, EN, IT, ES, FR, JA, CN, KO, PL, RU
Adjustable steam output	30 – 100 %
Measuring range	0.1 – 200 mg N
Reproducibility (RSD)	<1 %
Recovery	>99.5 % (1 – 200 mg N)
RS232 ports	2 (titrator, dosing unit)
USB port	1 (printer)
Safety sensors	3 (service door, protecting door, sample tube)
Sensor cooling water flow	Yes
Power supply	220 - 240 VAC $\pm$ 10 %
Frequency	50/60 Hz
Power consumption	2200 W

### Ambient conditions

For indoor use only.

Ambient temperature	5 - 40°C
Maximum relative humidity	80%

---

## Accessories

### Sample tubes and holders

	Order no.	Image
Sample tubes 300 mL For sample volumes up to 200 mL or 5 g in weight 4 pcs.	037377	
Sample tubes 300 mL 20 pcs.	11059690	
Sample tubes graduated 300 mL 4 pcs.	043049	
Sample tube 500 mL	026128	
Sample tubes 500 mL 4 pcs.	043982	
Sample tubes micro (100 mL) 4 pcs.	11057442	
Sample tube 750 mL including suction tube	11058999	
Sample tube holder (6 x 300 mL tubes)	043039	

	Order no.	Image
Sample tube holder (12 x 300 mL tubes)	043041	
Sample tube holder (4x 500 mL tubes)	016951	

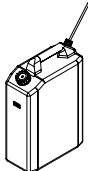
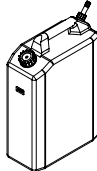
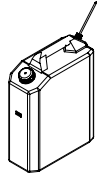
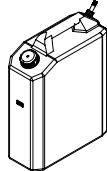
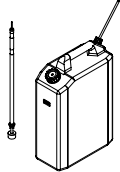
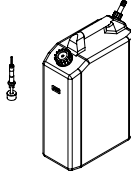

## Storage tanks and level sensors

	Order no.	Image
Storage tank (10 L) for chemicals	043468	
Storage tank (10 L) for waste	043470	
Storage tank (20 L) for chemicals	043469	
Storage tank (20 L) for waste	043471	
Storage tank (10 L) with level sensor for chemicals	043472	
Storage tank (10 L) with level sensor for waste	043474	

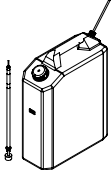
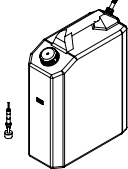
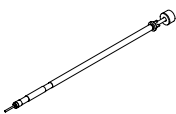
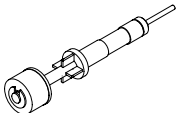
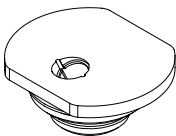

	Order no.	Image
Storage tank (20 L) with level sensor for chemicals	043473	
Storage tank (20 L) with level sensor for waste	043475	
Level sensor for chemical tank	043403	
Level sensor for waste tank	043404	
Rubber stopper for level sensor	043409	

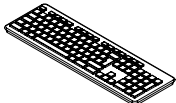
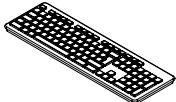
## Other accessories

	Order no.	Image
External PC keyboard (US)	031456	
External PC keyboard (CH)	031457	
Glass splash protector Devarda	043335	

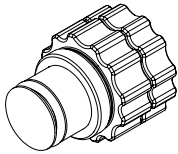
	Order no.	Image
Glass set for SO <sub>2</sub> determination	048680	
Cyanide caps Caps for hermetical closing of all types of Kjeldahl sample tubes during sample preparation for cyanide in food	11067871	

## Documentation

	Order no.
Kjeldahl Knowledge Base (EN) Comprehensive guide covering all aspects of the theoretical and practical know-how.	11595478
Kjeldahl Practice Guide (EN) Provides theoretical background information, useful hints and calculation tables for daily routine work	11592548
Kjeldahl Practice Guide (DE)	11592547
Kjeldahl Practice Guide (CN)	11592549
IQ/OQ set (EN) Complete set for Installation and Operational Qualification of the instrument	093189
IQ/OQ set (DE)	045541
Repeating OQ (EN)	11055493
Repeating OQ (DE)	11055494

## Titration accessories

	Order no.
Dispenser unit Titronic 300	11062956
Connection cable set for Titronic 300	11062927
Cable to external dosing device	043621
Cable to Mettler titrator (DL- and G-series)	043616
Cable to Metrohm (7-series)/Mettler (T-series) titrator	043617
Adapter for Metrohm 702/719 titrator	047803
Cable to Metrohm 916 Ti-Touch titrator	11064157
Cable to Metrohm Titrino Plus 877/848 titrator	11055333
Cable to SI-Analytics TitroLine Easy and TitroLine 5000 titrator	043618
Cable to Radiometer titrator	043619
Titration set (receiving vessel, holder, stirrer, valve)	043698
Sher indicator 100 mL	003512
Ammonium phosphate monobasic, 25 g	045527
2% boric acid pH 4.65 +/- 0.15 with Sher indicator, 5 L	11064972
4% boric acid pH 4.65 +/- 0.15 with Sher indicator, 5 L	11064973
4% boric acid pH 4.65 +/- 0.15 with bromocresol green / methly red mixed indicator, 5 L	11064976