

arteche



INSTANTANEOUS
AUXILIARY RELAYS

This document may be subject to changes. Contact ARTECHE to confirm the characteristics and availability of the products described here.



Moving together

INDEX

- 4. › Answers for any tripping application
- 5. › General characteristics
- 6. › Technical standards
- 7. › Range of products
- 10. › General purpose instantaneous relays
- 11. › Tripping relays
- 13. › Instantaneous relays with seismic characteristics
- 14. › Instantaneous relays with coil overvoltage protection
- 15. › Instantaneous relays with seismic characteristics and with coil overvoltage protection
- 16. › Breaking capacity
- 22. › Pick-up voltage/release voltage-temperature charts
- 24. › Model selection
- 26. › Dimensions and panel mounting cut-off

ANSWERS FOR ANY APPLICATION

ARTECHE instantaneous auxiliary relays are monoestable relays, whose output contacts change instantaneously from non-working position to working position when its coil is energized, coming back these contacts to the initial non-working position when the coil is no more fed.

ARTECHE instantaneous auxiliary relays range are designed to guarantee the best features and complete security even in the hardest working environment.

The design, durability and quality of the different alternatives that ARTECHE instantaneous relays can offer (FF range and standard range), make them suitable for high responsibility controls in different areas, highlighting:

ELECTRICAL UTILITIES:

Power plants, electrical substations.

- › Direct operation on MV / HV (circuit breaker, sectionalizer).
- › Galvanic isolation between the control system and the primary equipment.
- › Applications where high speed operation is a must.
- › Applications where high breaking capacity is required.
- › Tripping functions.
- › Contact multiplication in control systems of HV / MV installations and power plants.
- › Low duty loads control, activate digital inputs. FF range. Specific relays for Nuclear Power Plants.



RAILWAY SECTOR:

Electrification, signalling, interlocking and rolling stock.

- › Boarding doors locking.
- › Brake circuit command.
- › Security loop.
- › Pantograph control.
- › Lighting and air conditioned systems operation.
- › Traction system.
- › Low duty loads control, activate digital inputs. FF range.



INDUSTRIAL SECTOR:

Continuous process industries (Concrete, iron industries), water treatment, ...

- › Critical process surveillance.
- › Alarms for signalling and telecontrol.
- › Galvanic isolation between the control and the power systems.
- › Low duty loads control, activate digital inputs. FF range.

The great power of the output contacts makes possible direct action on HV and MV switchgear, because their making/breaking capacities, continuous through-current and overvoltage capacity guarantee perfect insulation.

GENERAL CHARACTERISTICS

The main features of ARTECHE's instantaneous auxiliary relays are the followings:

- › Designed to allow continuous operation even in high temperature ambient, within the whole voltage range.
- › Self-cleaning contacts.
- › High level of electrical insulation between input and output circuits.
- › Security contacts (EN 50205 Standard).
- › Availability of extended voltage range (+25/-30%) for high security applications.
- › Capable to operate under low duty loads, activate digital inputs, and operate without any load. **FF Range.**
- › High speed operation (up to 3 ms).
- › Capable to withstand vibrations and seismic conditions (EN 61373; IEEE 344; IEEE 323; IEEE C37.98 Standards).
- › Sturdy design.
- › Including an internal diode to avoid damaging the relay when connecting with inverse polarity.
- › High protection degree (IP40), with transparent cover, making them suitable for use in salty and tropical atmospheres.
- › In compliance with the most demanding test standards: IEC, EN, IEEE and bearing the CE mark.
- › Wide range of auxiliary voltage levels (Vdc and Vac).
- › Simplicity of installation (plug-in relays in a wide range of sockets with different installation configurations).
- › Capable to work under ambients with relative humidity around 100%.
- › No need of maintenance after installation.



In addition, the different number of alternatives that are offered when the equipment is selected, both technically (increase of the breaking capacity by serial contacts, high speed operation of the output contacts, possibility of adding different options to the relay) and in the assembly method (front, rear or flush mounted sockets, with screws or fastons) must be considered.

TECHNICAL STANDARDS

GENERAL STANDARDS

In addition to the specific applicable standards, ARTECHE auxiliary relays are designed based on the fulfilment of the following standards:

- › **IEC 61810:** Electromechanical all-or-nothing relays.
- › **IEC 60255:** Electrical relays. Measuring relays and protection equipment.
- › **IEC 61812:** Specified time relays for industrial use.
- › **IEC 60947:** Low-voltage switchgear and controlgear.
- › **IEC 61000:** Electromagnetic compatibility.

RAILWAY APPLICABLE STANDARDS

- › **EN 60077 Series.** Rolling stock equipment.
 - Part 1: General conditions in service and general terms.
 - Part 2: Electrotechnical components.
- › **EN 50155** (IEC 60571 equivalent). Railway applications - Electronic equipment used on rolling stock.
- › **IEC 61373.** Railway applications - Shock and vibration tests.
- › **NF F 16-101 y NF F 16-102.** Rolling stock fire behaviour.
- › **RIA 12.** General specification for protection of traction and rolling stock electronic equipment from transients and surges in DC control systems.
- › **EN 50121-3-2:2006.** Electromagnetic compatibility.
- › **EN 50205.** Relays with forcibly mechanically guided contacts. WELD NO TRANSFER.
- › **NF F 70-031.** Contact weld resistance tests. NO WELD CONTACTS.



UL Recognized Component Marks for USA and Canada: The combined UL signs for the USA and Canada are recognized by the authorities of both countries. All auxiliary relays identified with this mark meet the requirements of both countries.

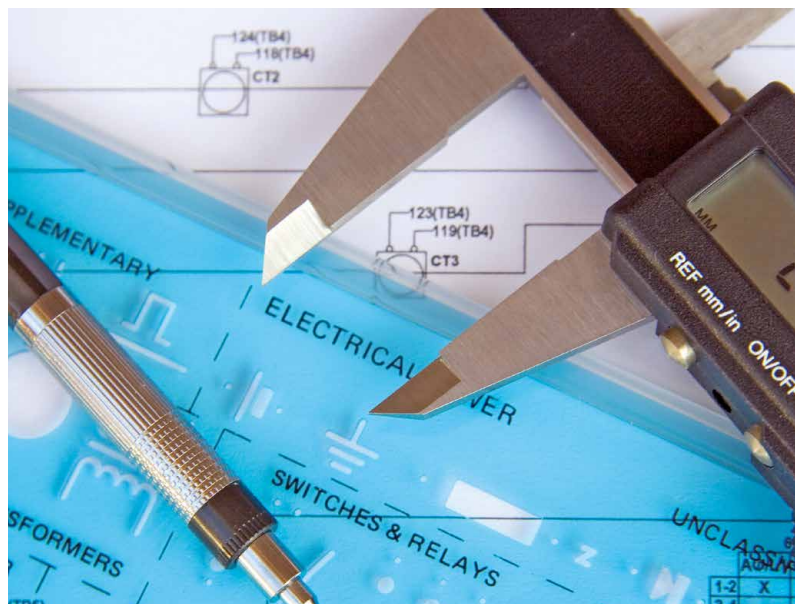

RANGE OF PRODUCTS

GENERAL PURPOSE INSTANTANEOUS AUXILIARY RELAYS

ARTECHE's general purpose instantaneous auxiliary relays are designed to directly operate to the tripping and control circuit.

Their pick-up time lower than 20 ms and the high breaking capacity of their contacts make them appropriate to be used as an interface between the protection system and the breaker. Furthermore, its multiple output contacts permit to use these relays in control and signalling applications as well as per direct operation on HV and MV primary equipments.



AUXILIARY TRIPPING INSTANTANEOUS RELAYS

ARTECHE offers specific relays intended to be used in tripping applications, where the requirements of pick-up time (with models that assure the trip even in less than 3 ms) and the breaking capacity are demanding, as the trip of HV and MV breakers.

These relays include a standard front LED that indicates when the relay is fed.

Relay trip flag is available, which indicates when the relay has operated, as a memory state.

All the relays include a diode in parallel with the coil (see auxiliary relays with overvoltage protection characteristic) and comply with the shock and vibration standards, related to the relays with seismic characteristics.



AUXILIARY INSTANTANEOUS RELAYS WITH SEISMIC CHARACTERISTICS

They are designed in order to properly perform under frequent vibration and shock applications, as railway sector, or because of safety requirements as nuclear power plants.

They comply with the extended voltage range (+25 / -30 %).

The sturdy design of our equipment, with a higher appropriate pressure between contacts, permits to withstand vibrations without penalizing the good performance of the relays.



INSTANTANEOUS AUXILIARY RELAYS WITH COIL OVERVOLTAGE PROTECTION

ARTECHE's auxiliary relays, either Vdc or Vac, have the possibility of including an element in parallel with the coil (diode or varistance).

In applications with overvoltage, where drop-out time is not important, it is recommended to use diode. Otherwise, varistance is more suitable.

These elements aimed to discharge the energy of the coil when the relay is not longer energized.

These relays are indicated when the customer wishes to protect the contact of the equipment that commands the operation of our relay, providing a longer durability of the whole protection and control system.



INSTANTANEOUS RELAYS



› Our relays are tested under extreme operating conditions, ensuring the highest level of safety and quality to operate your electrical assets.

GENERAL PURPOSE INSTANTANEOUS RELAYS

Model	RD-2	RF-4	RJ-8	RI-16
-------	------	------	------	-------



Applications

Contact multiplication directly to the tripping and control circuit.

Construction characteristics

Contacts no.	2 Changeover	4 Changeover	8 Changeover	16 Changeover
Connections				
Options	With OP options	With OP options - Push-to-test button included		Options are not available
Weight (g)	125	250	500	1250
Dimensions (mm)	22,5 x 50,4 x 72 (D short Type)	42,5 x 50,4 x 72 (F short Type)	82,5 x 50,4 x 72 (J short Type)	120 x 110 x 105
Coil characteristics				
Standard voltages ⁽¹⁾	24, 48, 72, 110, 125, 220 Vdc 24, 48, 63,5, 110, 127, 230, 400 ⁽⁴⁾ Vac (50-60 Hz)			24, 48, 72, 110, 125, 220 Vdc/Vca; 50/60 Hz
Voltage range	+10% -20% U _N			
Pick-up voltage				
Release voltage	See pick-up/release voltage-temperature curves			
Average consumptions in permanence (U _N)	2,6 W	3,9 W	6 W	10 W 12 VA
Operating time				
Pick-up time	<20 ms			<25 ms
Drop-out time	Vdc: <10 ms Vac or with LED: <50ms		Vdc: <15 ms Vac or with LED: <50ms	< 20 ms/Vdc < 45 ms/DI Vdc < 80 ms/Vac
Contacts				
Contact material	AgNi			
Contacts resistance ⁽²⁾	≤30 mΩ / ≤15 mΩ (FF Range)			
Distance between contacts	1,8 mm			
Permanent current	10 A			
Instantaneous current	30 A during 1 s / 80 A during 200 ms / 200 A during 10 ms			80 A during 200 ms / 150 A during 10 ms
Max. making capacity	40 A / 0,5 s / 110 Vdc			
Breaking capacity	See breaking capacity curves (Contact configuration type A)			
Max. breaking capacity	See value for 50.000 operations			
U _{max} opened contact	250 Vdc / 400 Vac			
General data				
Mechanical endurance	10 ⁷ operations			
Operating temperature	-65°C +70°C			-10°C +55°C
Storage temperature	-65°C +85°C			
Max. operating humidity	93% / +40°C			
Operating altitude ⁽³⁾	<2000 m			





⁽¹⁾ Other voltage upon request

⁽²⁾ Guarantee data for relays just manufactured

⁽³⁾ Ask for higher altitudes

⁽⁴⁾ Voltage not recognized by UL

TRIP RELAYS (I)

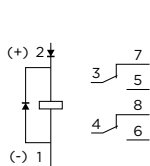
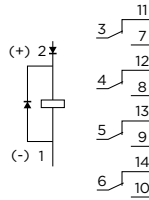
Model	RD-2R	RD-2XR	RF-4R	RF-4XR
				
Applications	Intended for tripping applications where high demanding requirements in operating time (with tripping time from 8ms to 3 ms) and breaking capacity are needed, that is the case of tripping HV and MV circuit breakers.			
Construction characteristics				
Contacts no.	2 Changeover		4 Changeover	
Connections				
Options	With OP options • LED included • Diode in parallel with the coil included			
Weight (g)	125		250	
Dimensions (mm)	22,5 x 50,4 x 72 (D short Type)		42,5 x 50,4 x 72 (F short Type)	
Coil characteristics				
Standard voltages ⁽¹⁾	24, 48, 110, 125, 220, 250 Vdc /110, 127, 230 Vac (50-60Hz)	48, 110, 125, 220, 250 Vdc	24, 48, 110, 125, 220, 250 Vdc / 110, 127, 230 Vac (50-60 Hz)	48, 110, 125, 220, 250 Vdc
Voltage range	+10% -20% U _N			
Pick-up voltage	See pick-up/release voltage-temperature curves			
Release voltage	See pick-up/release voltage-temperature curves			
Average consumptions	In permanence (U _N)	0,95 W		1 W
	Peak • ≤96 Vdc	0,8 A / 20 ms	2,5 A / 20 ms	0,8 A / 20 ms
	Peak • >96 Vdc	0,3 A / 20 ms	0,8 A / 20 ms	0,3 A / 20 ms
Operating time				
Pick-up time	<8 ms (<10 ms Vac)	<5,5 ms	<8 ms (<10 ms Vac)	<5,5 ms
Drop-out time	Vdc: <40 ms Vac: <50 ms	Vdc: <40 ms	Vdc: <40 ms Vac: <50 ms	Vdc: <40 ms
Contacts				
Contact material	AgNi			
Contacts resistance ⁽²⁾	≤30 mΩ			
Distance between contacts	1,2 mm			
Permanent current	10 A			
Instantaneous current	30 A during 1 s / 80 A during 200 ms / 200 A during 10 ms			
Max. making capacity	40 A / 0,5 s / 110 Vdc			
Breaking capacity	See breaking capacity curves (Contact configuration type B)			
Max. breaking capacity	See value for 50.000 operations			
U _{max} opened contact	250 Vdc / 400 Vac			
General data				
Mechanical endurance	10 ⁷ operations			
Operating temperature	-25°C +70°C			
Storage temperature	-40°C +85°C			
Max. operating humidity	93% / +40°C			
Operating altitude ⁽³⁾	<2000 m			

⁽¹⁾ Other voltage upon request

⁽²⁾ Guarantee data for relays just manufactured

⁽³⁾ Ask for higher altitudes

TRIP RELAYS (II)

Model	RJ-8R	RJ-8XR	RI-16R	RJ-4XR4*
-------	-------	--------	--------	----------



Applications Intended for tripping applications where high quality requirements in operating time (with models even tripping in less than 3 ms) and breaking capacity are needed, that is the case of tripping HV and MV circuit breakers.

Construction characteristics

Contacts no.	8 Changeover	16 Changeover	4 Changeover + 4 Fast Singles-Inversors without break power
--------------	--------------	---------------	---

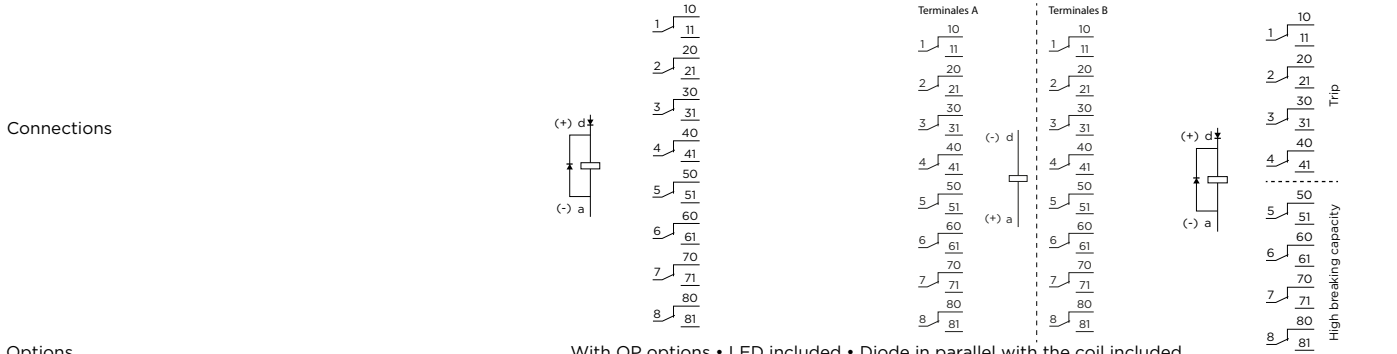

Options With OP options • LED included • Diode in parallel with the coil included

Weight (g)	500	1250	335
Dimensions (mm)	82,5 x 50,4 x 72 (J short Type)		82,5 x 50,4 x 72 (J short Type)

Coil characteristics

Standard voltages ⁽¹⁾	24, 48, 110, 125, 220, 250 Vdc/110, 127, 230 Vac (50-60 Hz)	48, 110, 125, 220, 250 Vdc	110, 125 220 Vdc	110, 125, 220, 250 Vdc
Voltage range	+10% -20% U _N		+15% -20% U _N	
Pick-up voltage	See pick-up/release voltage-temperature curves			
Release voltage	See pick-up/release voltage-temperature curves			
Average consumptions In permanence (U _N)	1,4 W	12 W	6,5 W	
Peak • ≤96 Vdc	0,8 A / 20 ms	2,5 A / 20 ms	25 W / 5 ms	
Peak • >96 Vdc	0,3 A / 20 ms	0,8 A / 20 ms		

Operating time

Pick-up time	<8 ms Vdc (<10 ms Vac) (Range 24 Vdc <10 ms)	<6,5 ms	< 10 ms	Contacts 1-4: <3 ms Contacts 5-8: <20 ms
Drop-out time	Vdc: <40 ms Vac: <50 ms	Vdc: <40 ms	< 10 ms Vcc / < 45 ms DI Vcc / < 80 ms Vca	Contacts 1-4: <25 ms Contacts 5-8: <50 ms

Contacts

Contact material	AgNi			
Contacts resistance ⁽²⁾	≤30 mΩ			
Distance between contacts	1,2 mm			Contacts 5-8: 1,2 mm
Permanent current	10 A			Contacts 1-4: 8 A Contacts 5-8: 15 A
Instantaneous current	30 A during 1 s / 80 A during 200 ms / 200 A during 10 ms	80 A during 200 ms / 150 A during 10 ms	Contacts 5-8: 30 A during 1 s / 80 A during 200 ms / 200 A during 10 ms	
Max. making capacity	40 A / 0,5 s / 110 Vdc		Contactos 5-8: 40 A / 0,5 s / 110 Vdc	
Breaking capacity	See breaking capacity curves (Contact configuration type B)			Contacts 5-8: See breaking capacity curves (Contact configuration type B)
Max. breaking capacity	See value for 50.000 operations			Contacts 5-8: See value for 50.000 operations
U _{max} opened contact	250 Vdc / 400 Vac			

General data

Mechanical endurance	10 ⁷ operations			
Operating temperature	-25°C +70°C	-10°C +55°C	-25°C +70°C	
Storage temperature	-40°C +85°C			
Max. operating humidity	93% / +40°C			
Operating altitude ⁽³⁾	<2000 m			

⁽¹⁾ Other voltage upon request
⁽²⁾ Guarantee data for relays just manufactured

⁽³⁾ Ask for higher altitudes * Not recognized by UL



INSTANTANEOUS RELAYS WITH SEISMIC CHARACTERISTICS

Model	RD-2SY	RF-4SY	RJ-8SY
-------	--------	--------	--------



Applications

Frequent vibration and shock applications, as railway sector, or because of safety requirements as nuclear power plants.

Construction characteristics

Contacts no.	2 Changeover	4 Changeover	8 Changeover
--------------	--------------	--------------	--------------

Connections

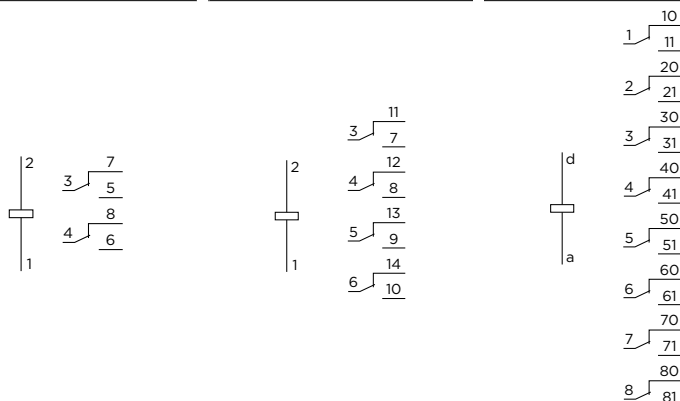

Options	With OP options	With OP options - Push-to-test button included	
---------	-----------------	--	--

Weight (g)	125	250	500
------------	-----	-----	-----

Dimensions (mm)	22,5 x 50,4 x 72 (D short Type)	42,5 x 50,4 x 72 (F short Type)	82,5 x 50,4 x 72 (J short Type)
-----------------	---------------------------------	---------------------------------	---------------------------------

Coil characteristics

Standard voltages ⁽¹⁾	24, 48, 72, 110, 125, 220 Vdc 24, 48, 63,5, 110, 127, 230, 400 ⁽⁴⁾ Vac (50-60 Hz)		
----------------------------------	--	--	--

Voltage range	+25% -30% U _N		
---------------	--------------------------	--	--

Pick-up voltage	See pick-up/release voltage-temperature curves		
-----------------	--	--	--

Release voltage	See pick-up/release voltage-temperature curves		
-----------------	--	--	--

Average consumptions in permanence (U _N)	2,6 W	3,9 W	6 W
--	-------	-------	-----

Operating time

Pick-up time	< 20 ms		
--------------	---------	--	--

Drop-out time	Vdc: <10 ms Vac or with LED: <50 ms	Vdc: <15 ms Vac or with LED: <50 ms	
---------------	--	--	--

Contacts

Contact material	AgNi		
------------------	------	--	--

Contacts resistance ⁽²⁾	≤30 mΩ / ≤15 mΩ (FF Range)		
------------------------------------	----------------------------	--	--

Distance between contacts	1,2 mm		
---------------------------	--------	--	--

Permanent current	10 A		
-------------------	------	--	--

Instantaneous current	30 A during 1 s / 80 A during 200 ms / 200 A during 10 ms		
-----------------------	---	--	--

Max. making capacity	40 A / 0,5 s / 110 Vdc		
----------------------	------------------------	--	--

Breaking capacity	See breaking capacity curves (Contact configuration type B)		
-------------------	---	--	--

Max. breaking capacity	See value for 50.000 operations		
------------------------	---------------------------------	--	--

U _{max} opened contact	250 Vdc / 400 Vac		
---------------------------------	-------------------	--	--

General data

Mechanical endurance	10 ⁷ operations		
----------------------	----------------------------	--	--

Operating temperature	-65°C +70°C		
-----------------------	-------------	--	--

Storage temperature	-65°C +85°C		
---------------------	-------------	--	--

Max. operating humidity	93% / +40°C		
-------------------------	-------------	--	--

Operating altitude ⁽³⁾	<2000 m		
-----------------------------------	---------	--	--

⁽¹⁾ Other voltage upon request

⁽²⁾ Guarantee data for relays just manufactured

⁽³⁾ Ask for higher altitudes

⁽⁴⁾ Voltage not recognized by UL

INSTANTANEOUS RELAYS WITH COIL OVERVOLTAGE PROTECTION

Model	RD-2DI / RD-2V	RF-4DI / RF-4V	RJ-8DI / RJ-8V	RI-16DI
-------	----------------	----------------	----------------	---------



Applications

Intended to protect the contact of the equipment that feeds the coil in our relay.

Construction characteristics

Contacts no.	2 Changeover	4 Changeover	8 Changeover	16 Changeover
--------------	--------------	--------------	--------------	---------------

Connections

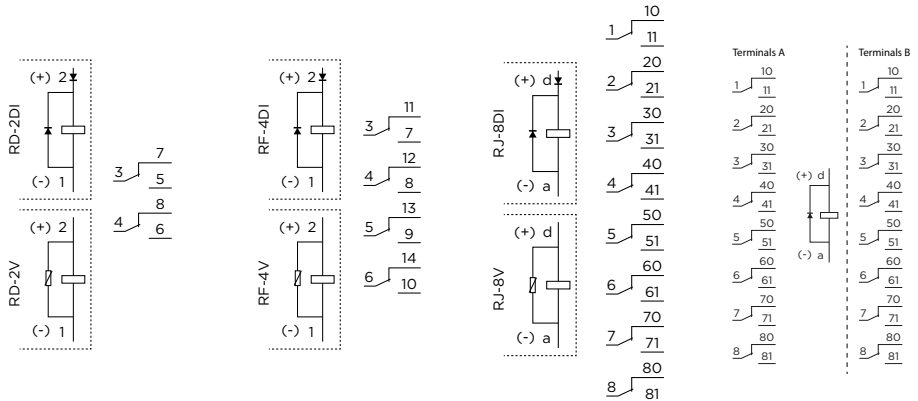

Options	With OP options	With OP options - Push-to-test button included	Options are not available
---------	-----------------	--	---------------------------

Weight (g)	125	250	500	1250
------------	-----	-----	-----	------

Dimensions (mm)	22,5 x 50,4 x 72 (D short Type)	42,5 x 50,4 x 72 (F short Type)	82,5 x 50,4 x 72 (J short Type)	120 x 110 x 105
-----------------	---------------------------------	---------------------------------	---------------------------------	-----------------

Coil characteristics

Standard voltages ⁽¹⁾	24, 48, 72, 110, 125, 220 Vdc	24, 48, 63,5, 110, 127, 230, 400 ⁽⁴⁾ Vac (50-60 Hz)	24, 48, 72, 110, 125, 220 Vcc/Vca; 50/60 Hz
----------------------------------	-------------------------------	--	---

Voltage range	+10% -20% U _N		
---------------	--------------------------	--	--

Pick-up voltage	See pick-up/release voltage-temperature curves		
-----------------	--	--	--

Release voltage	See pick-up/release voltage-temperature curves		
-----------------	--	--	--

Average consumptions in permanence (U _N)	2,6 W	3,9 W	6 W	10 W 12 VA
--	-------	-------	-----	------------

Operating time

Pick-up time	< 20 ms	< 25 ms
--------------	---------	---------

Drop-out time	V Series: <25ms DI Series: <50 ms	< 10 ms Vcc / < 45 ms DI Vdc / < 80 ms Vca
---------------	--------------------------------------	--

Contacts

Contact material	AgNi
------------------	------

Contacts resistance ⁽²⁾	≤30 mΩ / ≤15 mΩ (FF Range)
------------------------------------	----------------------------

Distance between contacts	1,8 mm
---------------------------	--------

Permanent current	10 A
-------------------	------

Instantaneous current	30 A during 1 s / 80 A during 200 ms / 200 A during 10 ms	80 A during 200 ms / 150 A during 10 ms
-----------------------	---	---

Max. making capacity	40 A / 0,5 s / 110 Vdc
----------------------	------------------------

Breaking capacity	See breaking capacity curves (Contact configuration type A)
-------------------	---

Max. breaking capacity	See value for 50.000 operations
------------------------	---------------------------------

U _{max} opened contact	250 Vdc / 400 Vac
---------------------------------	-------------------

General data

Mechanical endurance	10 ⁷ operations
----------------------	----------------------------

Operating temperature	-65°C +70°C	-10°C +55°C
-----------------------	-------------	-------------

Storage temperature	-65°C +85°C
---------------------	-------------

Max. operating humidity	93% / +40°C
-------------------------	-------------

Operating altitude ⁽³⁾	<2000 m
-----------------------------------	---------

⁽¹⁾ Other voltage upon request
⁽²⁾ Guarantee data for relays just manufactured

⁽³⁾ Ask for higher altitudes
⁽⁴⁾ Voltage not recognized by UL



INSTANTANEOUS RELAYS WITH SEISMIC CHARACTERISTICS AND WITH COIL OVERVOLTAGE PROTECTION

Model	RD-2SYDI RD-2SYV	RF-4SYDI RF-4SYV	RJ-8SYDI RJ-8SYV
-------	---------------------	---------------------	---------------------



Applications

Frequent Vibration and Shock applications, as railway sector, or because of safety requirements as nuclear power plants. Intended to protect the contact of the equipment that feeds the coil in our relay.

Construction characteristics

Contacts no.	2 Changeover	4 Changeover	8 Changeover
--------------	--------------	--------------	--------------

Connections

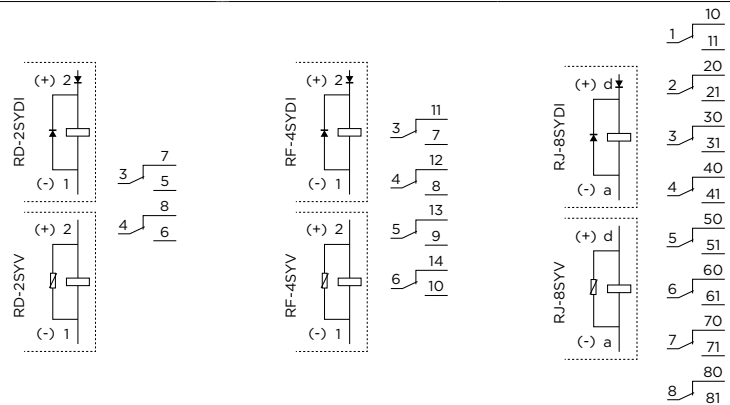

Options

With OP options

With OP options - Push-to-test button included

Weight (g)	125	250	500
Dimensions (mm)	22,5 x 50,4 x 72 (D short Type)	42,5 x 50,4 x 72 (F short Type)	82,5 x 50,4 x 72 (J short Type)

Coil characteristics

Standard voltages ⁽¹⁾	24, 48, 72, 110, 125, 220 Vdc 24, 48, 63,5, 110, 127, 230, 400 ⁽⁴⁾ Vac (50-60 Hz)
Voltage range	+25% -30% U _N
Pick-up voltage	See pick-up/release voltage-temperature curves
Release voltage	
Average consumptions in permanence (U _N)	2,6 W 3,9 W 6 W

Operating time

Pick-up time	< 20 ms
Drop-out time	V Series: <25ms DI Series: <50 ms

Contacts

Contact material	AgNi
Contacts resistance ⁽²⁾	≤30 mΩ / ≤15 mΩ (FF Range)
Distance between contacts	1,2 mm
Permanent current	10 A
Instantaneous current	30 A during 1 s / 80 A during 200 ms / 200 A during 10 ms
Max. making capacity	40 A / 0,5 s / 110 Vdc
Breaking capacity	See breaking capacity curves (Contact configuration type B)
Max. breaking capacity	See value for 50.000 operations
U _{max} opened contact	250 Vdc / 400 Vac

General data

Mechanical endurance	10 ⁷ operations
Operating temperature	-65°C +70°C
Storage temperature	-65°C +85°C
Max. operating humidity	93% / +40°C
Operating altitude ⁽³⁾	<2000 m

⁽¹⁾ Other voltage upon request

⁽²⁾ Guarantee data for relays just manufactured

⁽³⁾ Ask for higher altitudes

⁽⁴⁾ Voltage not recognized by UL

BREAKING CAPACITY



› With devices operating worldwide, also heavy industries like oil & gas sector trust in our relays.

BREAKING CAPACITY

The breaking capacity is a critical parameter on the design and the applications of the relays. Its mechanical life could be considerably reduced, depending on the value of the load (especially with heavy duty loads), the number of operations and the environmental conditions in which the relay is operating.

In any configuration, ARTECHE's auxiliary relays have a high breaking capacity values. These limits are showed in the table below, in terms of power and current values. In all the cases, these relays guarantee a right performance during 50,000 operations.

Likewise, the values showed in the following charts have been obtained in standard conditions in the laboratory, and they could be different in real conditions. In any case, the possibility of connecting serial contacts or a bigger distance between contacts makes these values to be considerably increased.

24 Vdc voltage Different loads configurations.

Resistive load:

› L/R= 0 ms.

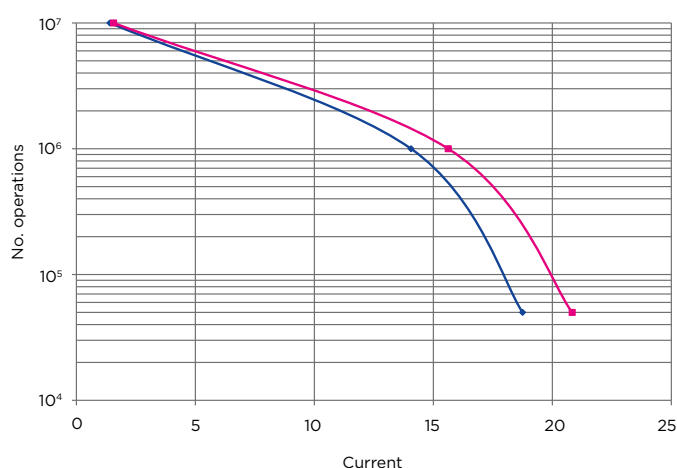

Highly inductive load:

› L/R= 40 ms.

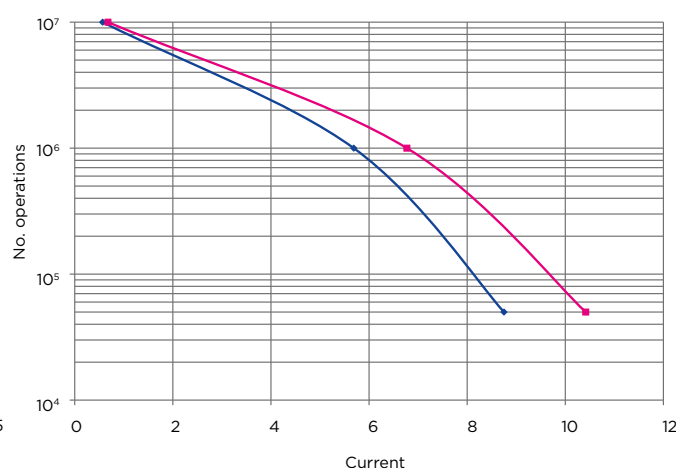

— Type A (Distance between contacts = 1,8 mm)
— Type B (Distance between contacts = 1,2 mm)

Vdc	Contact configuration	0 ms		20 ms		40 ms	
		P(W)	I(A)	P(W)	I(A)	P(W)	I(A)
24	Type A	500	20,83	370	15,42	250	10,42
	Type B	450	18,75	300	12,50	210	8,75

110 Vdc voltage
Different loads configurations.

Resistive load:

› L/R= 0 ms.

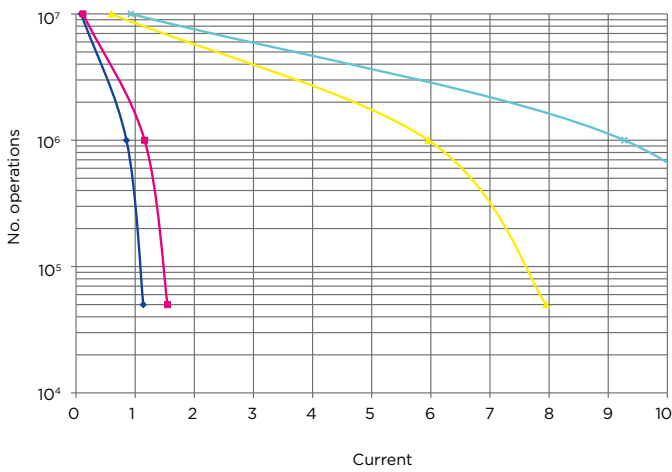

Highly inductive load:

› L/R= 40 ms.

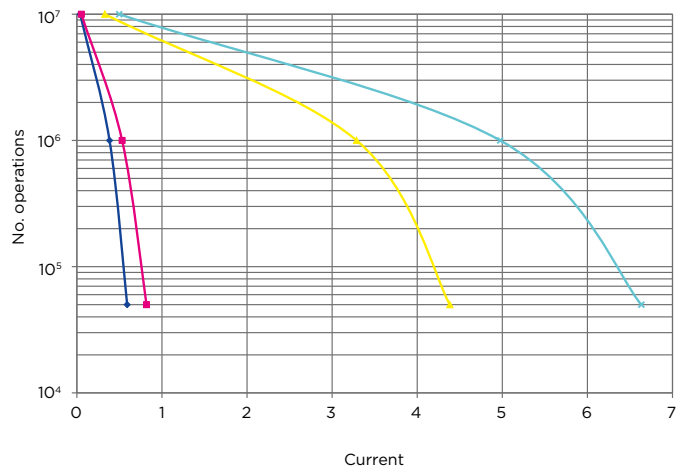

- Type A (Distance between contacts = 1,8 mm)
- Type B (Distance between contacts = 1,2 mm)
- 2 Contacts Type A
- 2 Contacts Type B

Vdc	Contact configuration	0 ms		20 ms		40 ms	
		P(W)	I(A)	P(W)	I(A)	P(W)	I(A)
110	Type A	170	1,55	140	1,27	90	0,82
	Type B	125	1,14	100	0,91	65	0,59
	2 Contacts Type A	1.360	12,36	1.106	10,05	730	6,63
	2 Contacts Type B	874	7,95	742	6,74	482	4,38

220 Vdc voltage Different loads configurations.

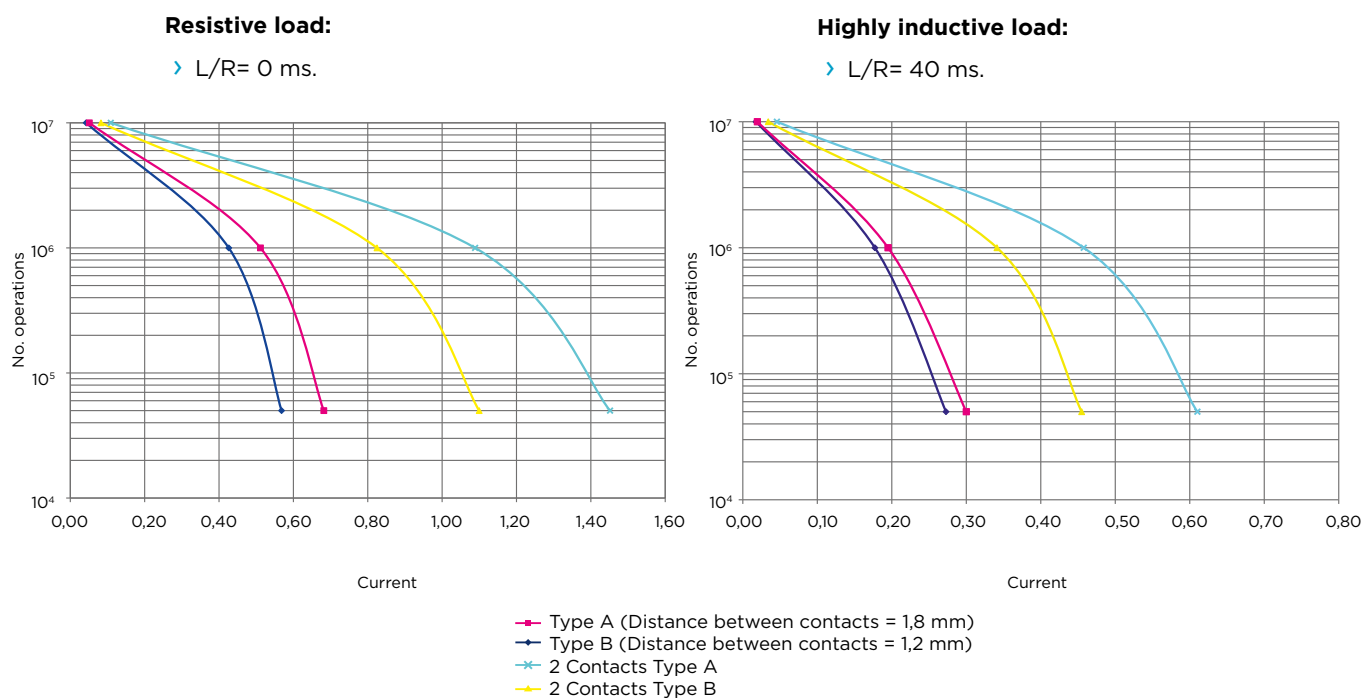

Vdc	Contact configuration	0 ms		20 ms		40 ms	
		P(W)	I(A)	P(W)	I(A)	P(W)	I(A)
220	Type A	150	0,68	115	0,52	66	0,30
	Type B	125	0,57	104	0,47	60	0,27
	2 Contacts Type A	319	1,45	234	1,06	134	0,61
	2 Contacts Type B	242	1,10	177	0,81	100	0,45

HOW TO SELECT THE CURVE OF MY RELAY

These charts show the breaking capacity values, either for resistive and highly inductive loads, in three voltage values of reference (ask for other voltage values). The charts show four different curves:

- › Type A: Breaking capacity of the relays with distance between contacts = 1.8 mm.
- › Type B: Breaking capacity of the relays with distance between contacts = 1.2 mm.
- › 2 contacts type A: Breaking capacity for relays with serial contacts, and distance between contacts=1.8 mm.
- › 2 contacts type B: Breaking capacity for relays with serial contacts, and distance between contacts=1.2 mm.

The distance between contacts is shown in the tables of technical data.

HOW THE BREAKING CAPACITY CAN BE INCREASED

ARTECHE's auxiliary relays are power relays, designed specially to have a high breaking capacity. Thus, there are applications where the loads are so high that it is necessary to even increase the breaking capacity, keeping the reliability of the contacts of the auxiliary relays.

Recommendations to increase breaking capacity:

- › Connect contacts in series. The breaking capacity is increased considerably, guaranteeing the right performance during a high number of operations. See curves for two contacts.
- › Use ARTECHE range of contactors. See ARTECHE contactors catalogue for more detailed information.

PICK-UP VOLTAGE/RELEASE VOLTAGE-TEMPERATURE CHARTS



GENERAL PURPOSE RELAYS AND RELAYS WITH COIL OVERTVOLTAGE PROTECTION

Operative range against ambient temperature.

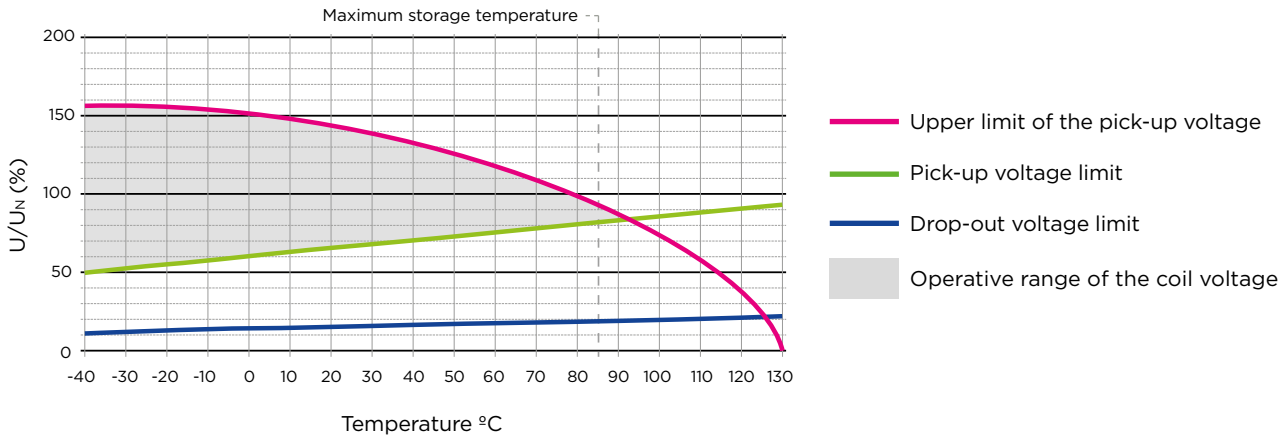

TRIPPING RELAYS

Operative range against ambient temperature.

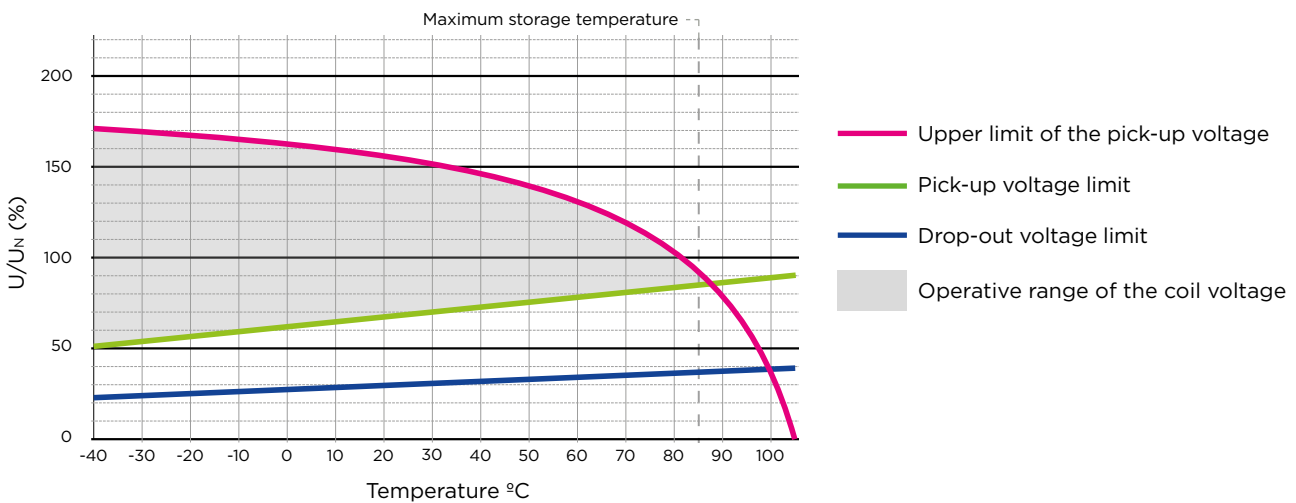

INSTANTANEOUS RELAYS WITH SEISMIC CHARACTERISTICS

Operative range against ambient temperature.

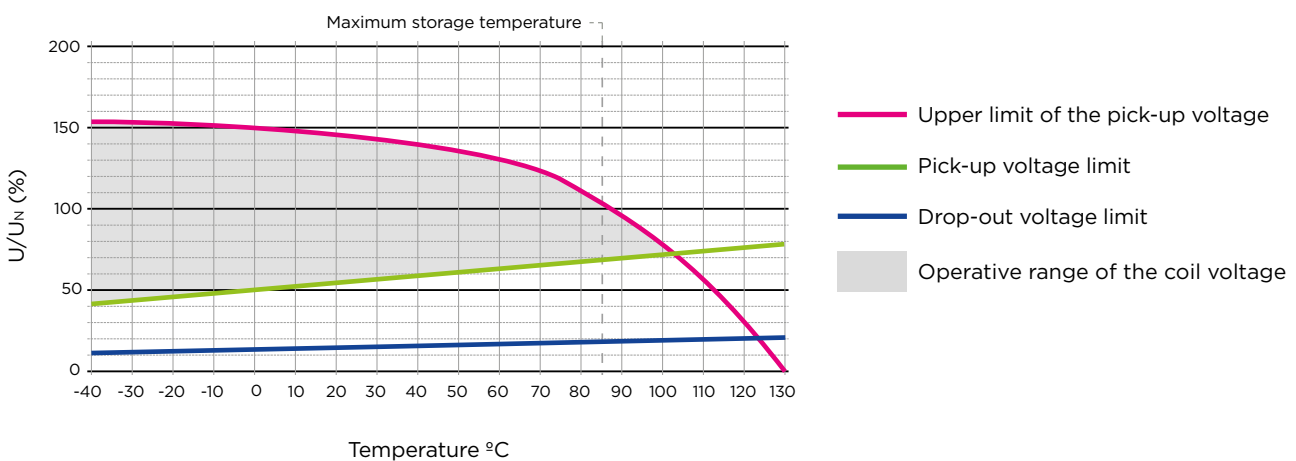

MODELS SELECTION

Instantaneous 2 contacts	Type	Range	Range FF*	Aux. Supply Vdc or Vac.	Options					
Model Selection ▶▶	RD-2				OP	0				
General purpose range	RD-2									
2 contacts relay	RD-2					0**	0	0	0	0
Tripping relays range										
Fast		R				0**	1	0	0	0
Extra-fast (Vdc only)		XR				0**	1	0	0	0
Seismic characteristics range										
Seismic		SY				0**	0	0	0	0
With coil overvoltage protection range										
Diode in parallel with the coil (only Vdc)		DI				0**	0	0	0	0
Varistance in parallel with the coil		V				0**	0	0	0	0
With seismic characteristics and coil overvoltage protection range										
Seismic with diode in parallel with the coil (only Vdc)		SYDI				0**	0	0	0	0
Seismic with varistance in parallel with the coil		SYV				0**	0	0	0	0
Range										
Rolling stock applications or low duty loads or guided contacts***	No		-							
	Yes		FF							
Aux. Supply Vdc or Vac										
Indicate voltage level and if it is VDC or VAC (ex: 24 VDC)										
Options										
Front LED	No						0			
	Yes						1			
Mechanical contact position indicator	No							0		
	Yes							1		
Trip flag	No								0	
	Yes								1	
Push to test button	No									0
	To push the contacts									1

Standard model

*Indicate just if FF range is required.

** Mandatory option.

*** For more information refer to railway application brochure.

Instantaneous 4-8-16 contacts		Type	Range	Range FF*	Aux. Supply Vdc or Vac.	Options					
Model Selection ▶▶						OP	0				
General purpose range											
4 contacts relay	RF-4					0**	0	0	0	1	
8 contacts relay	RJ-8					0**	0	0	0	1	
16 contacts relay	RI-16										
Tripping relays range											
Fast****		R				0**	1	0	0	0	
Extra-fast (Vdc only)****		XR				0**	1	0	0	0	
Ultra-fast (only Vdc)	RJ-4XR4					0**	1**	0**	0**	0**	
Seismic characteristics range											
Seismic****		SY				0**	0	0	0	1	
With coil overvoltage protection range											
Diode in parallel with the coil (only Vdc)		DI				0**	0	0	0	1	
Varistance in parallel with the coil		V				0**	0	0	0	1	
With seismic characteristics and coil overvoltage protection range											
Seismic with diode in parallel with the coil (only Vdc)****		SYDI				0**	0	0	0	1	
Seismic with varistance in parallel with the coil****		SYV				0**	0	0	0	1	
Range											
Rolling stock applications or low duty loads or guided contacts***	No			-							
	Yes			FF							
Aux. Supply Vdc or Vac											
Indicate voltage level and if it is VDC or VAC (ex: 24 VDC)											
Options											
Front LED	No								0		
	Yes								1		
Mechanical contact position indicator	No									0	
	Yes									1	
	Inverse*****									2	
Trip flag	No										0
	Yes										1
Push to test button	No										0
	To push the contacts										1

Standard model

* Indicate just if FF range is required.

** Mandatory option.

*** For more information refer to railway application brochure.

****Not an available option for the RJ-8.

*****Option only available for the RJ-8.

DIMENSIONS OF THE RELAYS

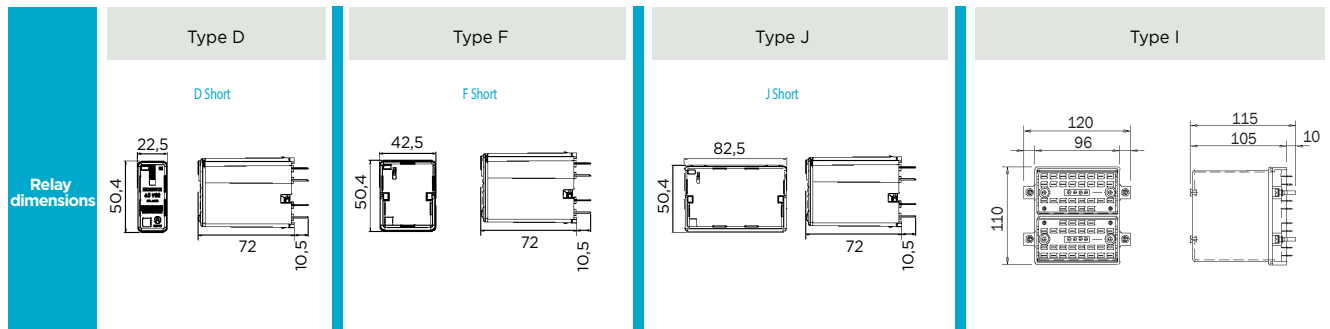

RETAINING CLIPS

RETAINING SPRING	OP SOCKET	RELATED PLUGGED RELAY
E0	Universal (D and F sized sockets require 2 units ; J sized sockets require 4 units)	RD; RF; RJ; TDF; TDJ; VDF OP; VDJ OP Universal (Bag of 20 units) Universal (Bag of 100 units)
E41	DN-DE IP, DN-DE 2C IP	RD OP
E50	DN-TR OP, DN-TR 2C OP	RD OP
E40	FN-DE IP, FN-DE 2C IP	RF OP
E43	FN-DE IP, FN-DE 2C IP	TDF OP; VDF OP
E42	FN-TR OP, FN-TR 2C OP	RF OP
E44	FN-TR OP, FN-TR 2C OP	TDF OP; VDF OP
E31	FN-DE IP, FN-DE 2C IP	BF
E21	FN-TR OP, FN-TR 2C OP	BF
E45	JN-DE IP, JN-DE 2C IP	RJ OP
E47	JN-DE IP, JN-DE 2C IP	TDJ OP; VDJ OP
E46	JN-TR OP, JN-TR 2C OP	RJ OP
E48	JN-TR OP, JN-TR 2C OP	TDJ OP; VDJ OP
E29	JN-DE IP, JN-DE 2C IP	BJ; UJ
E27	JN-TR OP, JN-TR 2C OP	BJ; UJ
OTHER ACCESSORIES		
Security pins for RD; RF; RJ; TDF; TDJ; VDF; VDJ relays (bag of 100 units)		



› E0 retaining clips

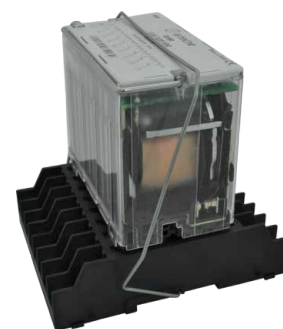

› E** retaining clips

SOCKETS: DIMENSIONS AND CUT-OUT

Sockets		Options			Weight (g)
Relay	Type	Screw	Faston	Double faston	
RD	IP10 Front connection	DN-DE IP10		DN-DE2C IP10	60
	IP20 Front connection	DN-DE IP20		DN-DE2C IP20	60
	IP10 Rear connection	DN-TR OP		DN-TR2C OP	50
RF	IP10 Front connection	FN-DE IP10		FN-DE2C IP10	110
	IP20 Front connection	FN-DE IP20		FN-DE2C IP20	110
	IP10 Rear connection	FN-TR OP		FN-TR2C OP	90
	IP10 Flush mounting (short)	F-EMP CORTA OP			300
RJ	IP10 Front connection	JN-DE IP10		JN-DE2C IP10	225
	IP20 Front connection	JN-DE IP20		JN-DE2C IP20	225
	IP10 Rear connection	JN-TR OP		JN-TR2C OP	180
	IP10 Flush mounting (short)	J-EMP CORTA OP			400
RI	IP10 Front connection	I-DE			1000
	IP10 Rear connection	I-TR		I-TR2C	500
	IP10 Flush mounting	I-EMP			500

Accessories
Retaining clips
Function signs on the extraction ring
Security pins

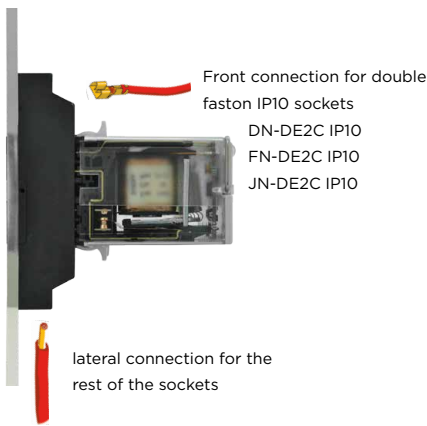

> Front connection socket

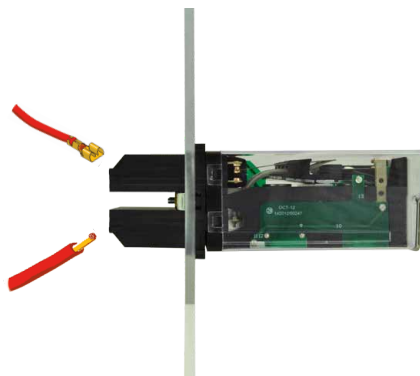

> Rear connection socket

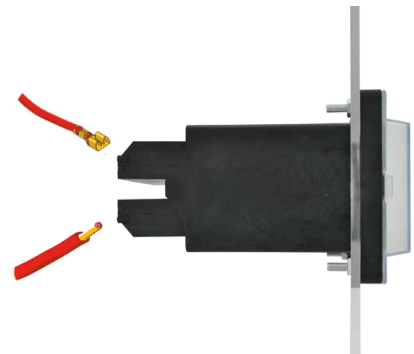

> Flush mounting socket

	Relays type D	Relays type F	Relays type J	Relays type I
Sockets for DIN rail (1), (2)	<p>DN-DE IP10 • DN-DE2C IP10</p>	<p>FN-DE IP10 • FN-DE2C IP10</p>	<p>JN-DE IP10 • JN-DE2C IP10</p>	<p>I-DE IP10</p>
	<p>DN-DE IP20 • DN-DE2C IP20</p> <p>Fix Drilling</p>	<p>FN-DE IP20 • FN-DE2C IP20</p> <p>Fix Drilling</p>	<p>JN-DE IP20 • JN-DE2C IP20</p> <p>Fix Drilling</p>	<p>Fix Drilling</p>
Sockets for rear connection	<p>DN-TR OP IP10 • DN-TR2C OP IP10</p>	<p>FN-TR OP IP10 • FN-TR2C OP IP10</p>	<p>JN-TR OP IP10 • JN-TR2C OP IP10</p>	<p>I-TR, I-TR2C IP10</p>
Sockets for flush mounting		<p>F-EMP IP10 SHORT OP</p>	<p>J-EMP IP10 SHORT OP</p>	<p>I-EMP IP10</p>
Cut-out				

⁽¹⁾ DIN rail according to EN50022 ⁽²⁾ Minimum distance between sockets will depend on type of relay and sockets. Please request sockets user manual for more detailed information.



arteche
Moving together



Updates: ARTECHE_CT_Instantaneous-Auxiliary-Relays_EN
Versión: 1.12