

Special Spark Plugs  
Ignition Ele

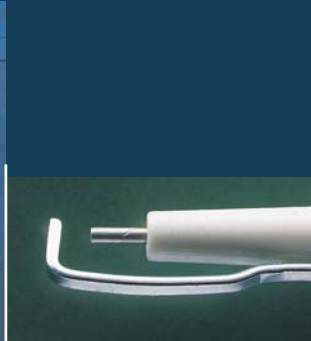
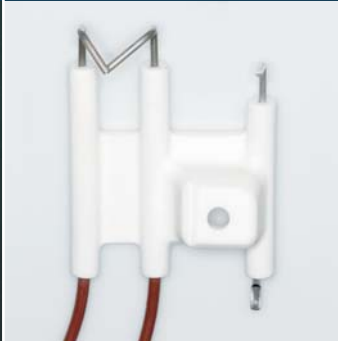

# Ignition Electrodes and Special Spark Plugs

Ignition Electrode  
Special Spark Plugs

Perfection  
built in



# Beru Ignition Electrodes – Quality Under One Roof

Due to decades of experience in vehicle and heating ignition systems, Beru has become the leader in the industry and is continually improving ignition electrodes. One example of this continuing improvement is the ceramic body, specially developed to provide fracture stability and dielectric strength. Other examples are the gas-sealed electrode and the 2-part center electrode, which is reinforced through glass sealing and has a particularly high mechanical strength. Another improvement is the elongation and distortion resistance of the center electrodes in the ceramic body. The examples could go on and on.

We will be happy to give you a presentation of a cross-sectional sample of our development expertise including spark plugs for gas-powered engines. To produce special and small series, we use our sample workshops, which are modernly equipped and flexible. If you are interested in individual ignition electrode components, discuss it with us; we'll make you an attractive offer.

## ◀ The Beru individual ignition electrode range

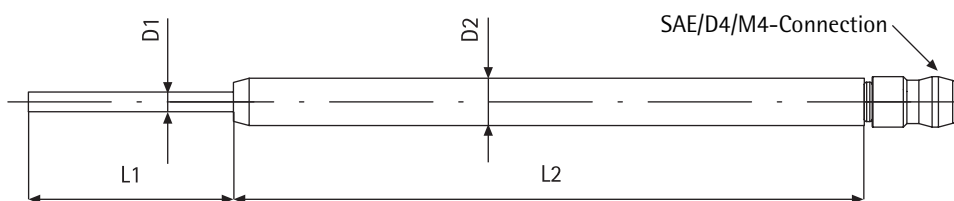

Length, diameter, wiring material and insulator material on demand.

We will be pleased to provide you with an offer for bent electrodes in accordance with your specifications.

## ◀ The basis of our double ignition electrode program

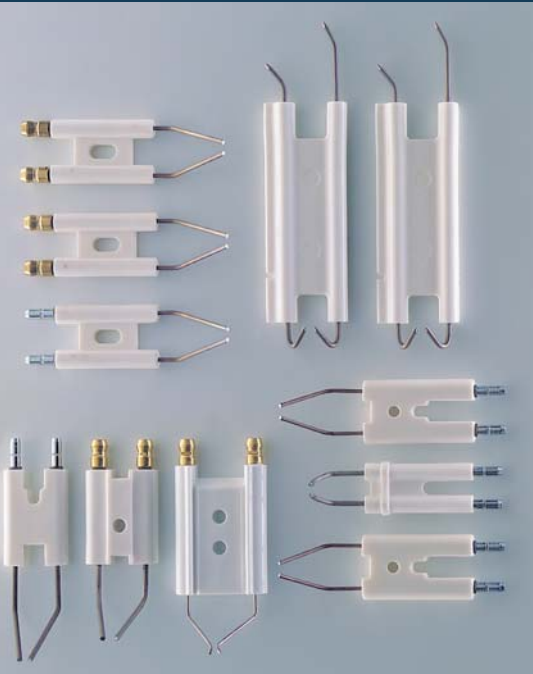

### Sheet electrodes

Some examples of our sheet electrode production program



# Beru Special Ignition Electrodes – also suitable for special applications such as level and temperature monitoring

## The ZE special spark plugs with single electrodes

Description	Thread (mm)	Thread length LG (mm)	Length L (mm)	Material Center Electrode	∅ Center Electrode (mm)	Order No.
ZE 14-8-70 A1	M 14x1.25	8	70	Kanthal A1	2.5	0 009 350 028
ZE 14-8-250 A1	"	8	250	"	2.5	0 009 350 025
ZE 14-8-400 A1	"	8	400	"	2.5	0 009 350 026
* ZE 14-12-35 A1	"	12	35	"	3.5	0 009 340 040
* ZE 14-12-66 A1	"	12	66	"	"	0 009 340 094
ZE 14-12-100 A1	"	12	100	"	"	0 009 340 041
ZE 14-12-150 A1	"	12	150	"	"	0 009 340 045
* ZE 14-12-200 A1	"	12	200	"	"	0 009 340 028
* ZE 14-12-300 A1	"	12	300	"	"	0 009 340 038
ZE 14-12-400 A1	"	12	400	"	"	0 009 340 042
ZE 14-12-600 A1	"	12	600	"	"	0 009 340 024
ZE 14-12-1000 A1	"	12	1000	"	"	0 009 340 083
* ZE 14-12-1200 A1	"	12	1200	"	"	0 009 340 035
ZE 14-12-66	"	12	66	NiCr 8020	"	0 009 340 021
ZE 14-12-200	"	12	200	"	"	0 009 340 012
ZE 14-12-200X	"	12	200	X10CrNi 188	3.5	0 009 340 095
ZE 18-12-50 A1	M 18x1.5	12	50	Kanthal A1	"	0 009 380 032
ZE 18-12-150 A1	"	12	150	"	"	0 009 380 047
ZE 18-12-300 A1	"	12	300	"	"	0 009 380 016
ZE 18-12-400 A1	"	12	400	"	"	0 009 380 017
ZE 18-12-600 A1	"	12	600	"	"	0 009 380 019
* ZE 18-12-1200 A1	"	12	1200	"	"	0 009 380 045
ZE 18-12-1550 A1	"	12	1550	"	"	0 009 380 055
FLE G1/2-12-10	G 1/2*	15	10	X12CrNi 188	M4	0 009 390 001

Connection: M4 thread \* - short delivery  
\* DIN ISO

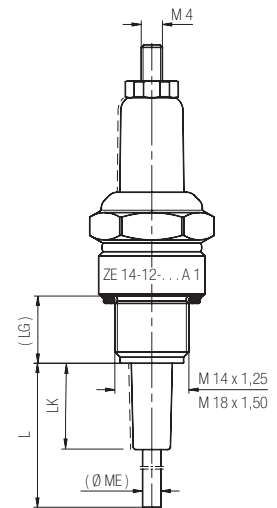



## The ZK special spark plugs with earth electrodes

Description	Thread (mm)	Thread length LG (mm)	Length L (mm)	Ceramic length LK (mm)	Order No.
ZK 14-8-15 A1	M14	8	15	11	0 004 500 401
ZK 14-8-22 A1	M14	8	22	11	0 004 500 419
ZK 14-8-37 A1	M14	8	37	11	0 004 500 601
ZK 14-8-75 A1	M14	8	75	11	0 004 500 421
ZK 14-12-28 A1	M14	12	28	16.3	0 004 400 404
ZK 14-12-35 A1	M14	12	35	16.3	0 004 400 405
ZK 14-12-35 2 LA1	M14	12	35	23.3	0 004 400 400
ZK 14-12-50 A1	M14	12	50	16.3	0 004 400 406
ZK 14-12-75 2 LA1	M14	12	75	23.3	0 004 400 402
ZK 14-12-100 LA1	M14	12	100	23.3	0 004 400 401
ZK 18-12-38 2 LA1	M18	12	38	23.3	0 004 800 400

Center electrode  
Kanthal A1  
Connection M4 thread



## The ZK 18-12 special spark plugs with safety tubes ▶

	Length L (mm)	Order No.	
ZK 18-12-145 URA 1	145	0 004 800 614	
ZK 18-12-236 URA 1	236	0 004 800 615	
ZK 18-12-245 URA 1	245	0 004 800 612	
ZK 18-12-750 URA 1	750	0 004 800 601	
ZK 18-12-900 URA 1	900	0 004 800 604	
ZK 18-12-1050 URA 1	1050	0 004 800 613	
ZK 18-12-1104 URA 1	1104	0 004 800 610	
ZK 18-12-236 ZRA 1	236	0 004 800 607	
ZK 18-12-386 ZRA 1	386	0 004 800 618	
ZK 18-12-245 RA 1	245	0 004 800 401	
ZK 18-12-450 RA 1	450	0 004 800 409	
ZK 18-12-900 RA 1	900	0 004 800 403	

Connection: M4 thread  
 Length of thread LG 12 mm  
 Inconel safety tube, diam. 15 mm  
 Center and ground electrode made of Kanthal A1

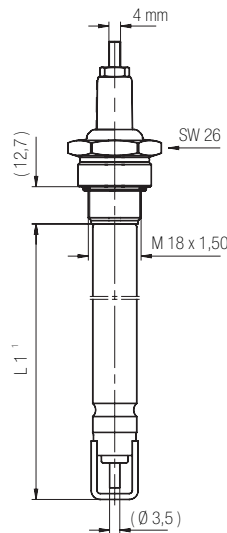

Beru spark plugs are specially manufactured to customer specifications: In any length desired – and, if planned for periodic use, also with the corresponding humidity insulation. We will be happy to provide you with a detailed offer.

## Other things you should know ...

Insulators made of aluminium oxide AL2 O3 > 95 % C 795  
 Steatit C 221

### Accessories:

SAE cable connecting nut 6.3 mm,  
 capable of being screwed on M4 thread.  
 100 units per pack

Design ZnAl order no. 2 004 652 001  
 Design silver steel order no. 2 004 634 001  
 Design brass order no. 2 004 650 013

M14 x 1.25 flat-ended nut, order no. 2 903 021 011  
 BEN 2014 H DIN 439 Stvz

Electrode material Kanthal A1, APM, D, N80, alu chrome (J,Y,O)  
 or Krupp VDM on request. Supply of different  
 electrode wire materials in  $\varnothing$  1.2-3.5 mm (length 3 m)  
 Insulators on request, various support insulators e.g. Isol. 1013,  
 65 mm with 13.4 mm  $\varnothing$  appropriate for ZE 14-12

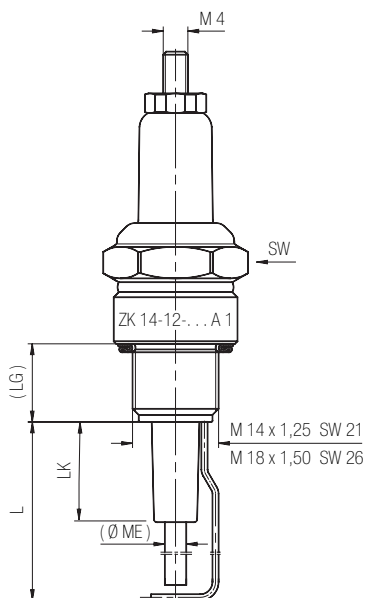

# Distinguishing factors between a Beru ignition Electrode and other ignition electrodes.

Unlike other manufacturers, we not only assemble products, we also manufacture them completely ourselves. Each individual component of a Beru ignition electrode is manufactured at the Beru factory - starting with the preparation of the ceramic material. The advanced ceramic production process at our Neuhaus-Schierschnitz plant enables us to manufacture our own insulators using high-quality aluminium oxide (>95 %). The production is geared towards the design and application requirements of the ignition electrode. The product is either molded isostatically and then sanded or the ceramic is molded by injection. This technology, which is still very new and only offered by a few manufacturers, enables geometrically extremely sophisticated and complex components to be manufactured to ultimate precision.

The Beru plant at Neuhaus-Schierschnitz - like all Beru's German plants - meets the internationally recognized requirements of DIN ISO 9001, ISO/TS 16949 as well as the Environmental Standard DIN ISO 14001.

These certificates are only awarded following an extensive testing process and testify to the company's competence to meet the highest standard of quality in development, manufacture, sales and management.



*The Beru plant at Neuhaus-Schierschnitz: the industrial ceramic production factory belongs to Beru since 1991 and has been continually expanding ever since then.*

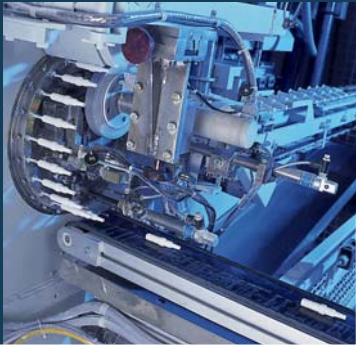

*Rotation-symmetrical insulators are isostatically molded and then sanded exactly to comply with the strict production tolerance levels.*



*Latest technology at work: the injection molding plant at Beru's Neuhaus-Schierschnitz factory also enables complex ceramic body geometries to be created. Undercuts can also be produced.*

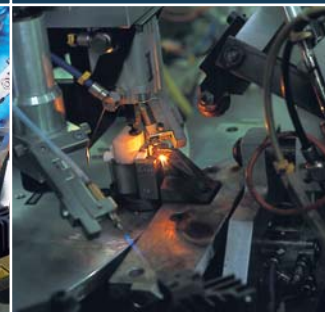
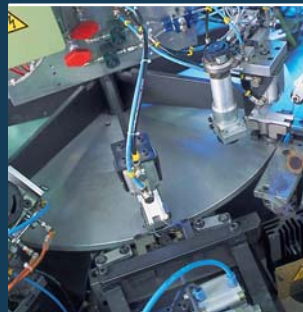

*Maximum precision also in electrode bending: the computerized automatic hot bending unit with built-in dimension controls. The bending points are annealed in order to prevent spring-back.*



*Production of sheet electrodes: the insulators are pressed into the mounting plate.*



*The baking of the ceramic components takes place 24 hours a day at a temperature of 1,650 °C.*

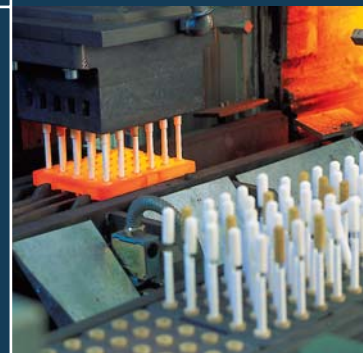

*The glass seal connects the electrode wires with the ceramic housing.*

# Ignition Electrodes Special Spark Plugs

IGNITION ELECTRODES AND SPECIAL SPARK PLUGS



BERU Aktiengesellschaft  
Abteilung VIG  
Mörkestrasse 155 · D-71636 Ludwigsburg  
Postfach 229 · D-71602 Ludwigsburg  
Telefon: ++49-71 41-132-2 63  
Telefax: ++49-71 41-132-3 89  
E-Mail: [info@beru.de](mailto:info@beru.de)  
[www.beru.com](http://www.beru.com)