



# ***CONTACTORS, RELAYS, SEMICONDUCTOR RELAYS***

## ***Contactors***



## ***Relays***



## ***Semiconductor relays***



**GEV Großküchen-Ersatzteil-Vertrieb GmbH**  
Robert-Koch-Straße 3a  
82152 Planegg/Munich  
Germany

Phone: +49 (0)89 745572-0  
Fax: +49 (0)89 745572-83  
order@gev-online.com  
www.gev-online.com

**Member of the GEV GROUP**

# TABLE OF CONTENT

©GEV 2008

## Contactors ABB



page 4

## Contactors GE/AEG



page 6

## Contactors LOVATO



page 8

## Contactors ISKRA (FANAL)



page 10

## Contactors SIEMENS



page 12

## Contactors TELEMECANIQUE



page 14

Contactors, relays, semiconductor relays ©

## Contactors *BENEDIKT & JÄGER*



page 16

## Contactors various



page 17

## Installation contactors



page 17

## Motor protective circuit breaker



page 18

## Relays



page 18

## Semiconductor relays



page 24

## contactors ABB motor contactors



item	order no.	supply	resistive load AC1	motor performance AC3	main contacts	auxiliary contacts	connection	producer-type
1	381011	230VAC	16A	9A/4KW	2NO/2NC		screw connection	B6-22-00
1	380102	24VAC	20A	12A/5,5KW	3NO	1NO	screw connection	B7-30-10
1	380103	24VAC	20A	12A/5,5KW	3NO	1NC	screw connection	B7-30-01
1	380100	230VAC	20A	12A/5,5KW	3NO	1NO	screw connection	B7-30-10
1	380101	230VAC	20A	12A/5,5KW	3NO	1NC	screw connection	B7-30-01
1	380092	230VAC	20A	12A/5,5KW	4NO		screw connection	B7-40-00
1	380110	400VAC	20A	12A/5,5KW	3NO	1NO	screw connection	B7-30-10
1	380111	400VAC	20A	12A/5,5KW	3NO	1NC	screw connection	B7-30-01
2	380095	230VAC	20A	12A/5,5KW	3NO	1NO	faston 6,3mm	B7-30-10-F
2	380096	230VAC	20A	12A/5,5KW	3NO	1NC	faston 6,3mm	B7-30-01-F
3	380097	24VAC	20A	12A/5,5KW	3NO	1NO	soldering pins	B7-30-10-P
3	380098	24VAC	20A	12A/5,5KW	3NO	1NC	soldering pins	B7-30-01-P
4	380099	230VAC	20A	12A/5,5KW	2x3NO	2xNO	screw connection	VB7-30-10
4	380125	230VAC	20A	12A/5,5KW	2x3NO	2xNC	screw connection	VB7-30-01
5	381012	24VAC	20A	12A/5,5KW	2x3NO	2xNO	soldering pins	VB7-30-10-P
5	381013	24VAC	20A	12A/5,5KW	2x3NO	2xNC	soldering pins	VB7-30-01-P

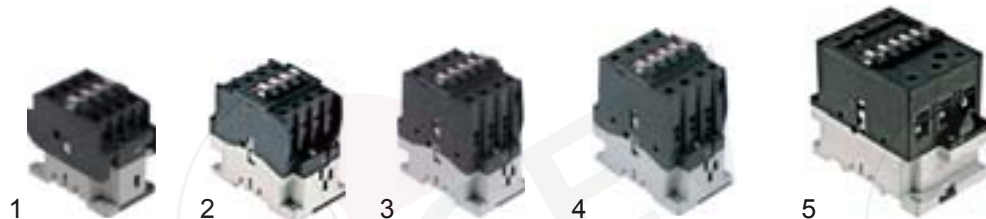

item	order no.	supply	resistive load AC1	motor performance AC3	main contacts	auxiliary contacts	connection	producer-type
1	380106	24VAC	25A	9A/4KW	3NO	1NO	screw connection	A9-30-10
1	380107	24VAC	25A	9A/4KW	3NO	1NC	screw connection	A9-30-01
1	380104	230VAC	25A	9A/4KW	3NO	1NO	screw connection	A9-30-10
1	380105	230VAC	25A	9A/4KW	3NO	1NC	screw connection	A9-30-01
1	380117	230VAC	25A	9A/4KW	4NO	-	screw connection	A9-40-00
1	380115	400VAC	25A	9A/4KW	3NO	1NO	screw connection	A9-30-10
1	380116	400VAC	25A	9A/4KW	3NO	1NC	screw connection	A9-30-01
1	381015	230VAC	27A	12A/5,5KW	3NO	1NO	screw connection	A12-30-10
1	381016	230VAC	27A	12A/5,5KW	3NO	1NC	screw connection	A12-30-01
1	380108	230VAC	30A	17A/7,5KW	3NO	1NO	screw connection	A16-30-10
1	380109	230VAC	30A	17A/7,5KW	3NO	1NC	screw connection	A16-30-01
1	381017	230VAC	30A	17A/7,5KW	4NO	-	screw connection	A16-40-00
2	381022	24VAC	45A	26A/11KW	3NO	1NO	screw connection	A26-30-10
2	381023	24VAC	45A	26A/11KW	3NO	1NC	screw connection	A26-30-01
2	380112	230VAC	45A	26A/11KW	3NO	1NO	screw connection	A26-30-10
2	380113	230VAC	45A	26A/11KW	3NO	1NC	screw connection	A26-30-01
2	381018	230VAC	45A	26A/11KW	4NO	-	screw connection	A26-40-00
2	381019	400VAC	45A	26A/11KW	3NO	1NO	screw connection	A26-30-10
2	381020	400VAC	45A	26A/11KW	3NO	1NC	screw connection	A26-30-01
3	380114	230VAC	55A	32A/15KW	3NO	1NO	screw connection	A30-30-10
3	381021	230VAC	55A	32A/15KW	3NO	1NC	screw connection	A30-30-01
4	381024	230VAC	60A	37A/18,5KW	3NO	1NO	screw connection	A40-30-10
4	381025	230VAC	60A	37A/18,5KW	3NO	1NC	screw connection	A40-30-01
5	381026	23VAC	100A	50A/22KW	3NO	-	screw connection	A50-30-00

## auxiliary contactors



pos.	order no.	supply	resistive load AC1	electromagnetic power AC15	contacts	connection	producer-type
1	380122	230VAC	10A	3A	2NO/2NC	screw connection	N22E
2	380123	230VAC	10A	3A	3NO/1NC	screw connection	N31E
3	380124	230VAC	10A	3A	4NO	screw connection	N40E

## auxiliary contacts



item	order no.	contacts	resistive load AC1	electromagnetic power AC15	connection	for contactors	producer-type
1	381027	1NO/1NC	6A	3A	screw connection		CA6-11E
2	381028	1NO/1NC	6A	3A	screw connection	B6	CAF6-11E
2	381029	2NO	6A	3A	screw connection	B7	CAF6-20E
2	381030	2NC	6A	3A	screw connection	VB7	CAF6-02E
3	380127	1NO	16A	3A	screw connection		CA5-10
3	380126	1NC	16A	3A	screw connection		CA5-01
4	380128	2NO/2NC	16A	3A	screw connection		CA5-22E
4	381037	4NO	16A	3A	screw connection	A9 up to A50	CA5-40E
4	381038	3NO/1NC	16A	3A	screw connection		CA5-31E
5	381031	1NO/1NC	16A	3A	screw connection		CAL5-11

## RC circuits



pos.	order no.	operating voltage range	for contactors	producer-type	pos.	order no.	operating voltage range	for contactors	producer-type
1	381032	24–50VAC		RC5-1/50	4	381035	110–250VAC	A50	RC5-2/250
2	381033	110–250VAC	A9 up to A40	RC5-1/250					
3	381034	250–440VAC		RC5-1/440					

## overload switches



pos.	order no.	setting range	for contactors	producer-type	pos.	order no.	setting range	for contactors	producer-type
1	380140	0,16–0,25A		TA25DU 0,25	8	380149	2,2–3,1A		TA25DU 3,1
2	380141	0,25–0,4A		TA25DU 0,4	9	380150	2,8–4A		TA25DU 4,0
3	380142	0,4–0,63A		TA25DU 0,63	10	380152	3,5–5A		TA25DU 5,0
4	380144	0,63–1A	A9 up to A40	TA25DU 1,0	11	380153	4,5–6,5A	A9 up to A40	TA25DU 6,5
5	380145	1–1,4A		TA25DU 1,4	12	380156	6–8,5A		TA25DU 8,5
6	380146	1,3–1,8A		TA25DU 1,8	13	380158	7,5–11A		TA25DU 11
7	380148	1,7–2,4A		TA25DU 2,4	14	381036	10–14A		TA25DU 14

## contactors GE/AEG

### motor contactors

©GEV 2008

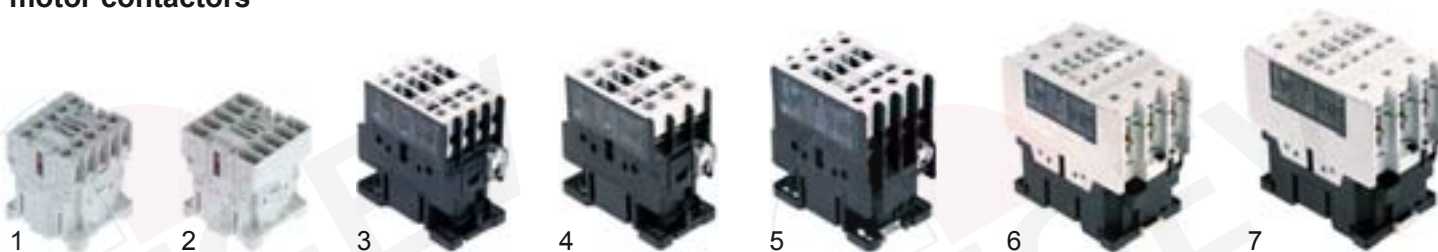

item	order no.	supply	resistive load AC1	motor performance AC3	main contacts	auxiliary contacts	connection	producer-type (GE)	producer-type (AEG)
1	380839	24VAC	20A	9A/4kW	3NO	1NO	screw connection	MC1A310AT1	LS05.10A
1	380840	24VAC	20A	9A/4kW	3NO	1NC	screw connection	MC1A310AT1	LS05.01A
1	380238	230VAC	20A	9A/4kW	3NO	1NO	screw connection	MC1A310AT6	LS05.10A
1	380239	230VAC	20A	9A/4kW	3NO	1NC	screw connection	MC1A301AT6	LS05.01A
1	380337	230VAC	20A	9A/4kW	4NO		screw connection	MC1A400AT6	LS05.4.00A
1	380837	400VAC	20A	9A/4kW	3NO	1NO	screw connection	MC1A310ATU	LS05.10A
1	380838	400VAC	20A	9A/4kW	3NO	1NC	screw connection	MC1A301ATU	LS05.01A
2	380845	230VAC	16A	9A/4kW	3NO	1NO	faston 6,3mm	MC1A310AFN	LS05.10FA
2	380846	230VAC	16A	9A/4kW	3NO	1NC	faston 6,3mm	MC1A301AFN	LS05.01FA
2	380498	230VAC	16A	9A/4kW	4NO		faston 6,3mm	MC1A400AFN	LS05.4.00FA
3	380248	24VAC	25A	9A/4kW	3NO	1NO	screw connection	CL00A310T1	LS4K.10A
3	380249	24VAC	25A	9A/4kW	3NO	1NC	screw connection	CL00A301T1	LS4K.01A
3	380244	230VAC	25A	9A/4kW	3NO	1NO	screw connection	CL00A310T6	LS4K.10A
3	380245	230VAC	25A	9A/4kW	3NO	1NC	screw connection	CL00A301T6	LS4K.01A
3	381095	230VAC	25A	9A/4kW	4NO		screw connection	CL0114005	
3	380246	400VAC	25A	9A/4kW	3NO	1NO	screw connection	CL00A310TU	LS4K.10A
3	380247	400VAC	25A	9A/4kW	3NO	1NC	screw connection	CL00A301TU	LS4K.01A
3	380261	230VAC	32A	18A/7,5kW	3NO	1NO	screw connection	CL02A310T6	LS7K.10A
3	380262	230VAC	32A	18A/7,5kW	3NO	1NC	screw connection	CL02A301T6	LS7K.01A
3	380263	230VAC	32A	18A/7,5kW	4NO		screw connection	CL02A400T6	LS7K.4.00A
4	380671	24VAC	45A	25A/12kW	3NO		screw connection	CL25A300T1	LS11K.00A
4	380264	230VAC	45A	25A/12kW	3NO		screw connection	CL25A300T6	LS11K.00A
5	380265	230VAC	60A	32A/16kW	3NO	1NO	screw connection	CL04A310M6	LS15K.10A
5	380385	230VAC	60A	32A/16kW	3NO	1NC	screw connection	CL04A301M6	LS15K.01A
6	380695	230VAC	90A	50A/22kW	3NO		screw connection	CL06A300M6	LS22K.00A
7	380267	230VAC	110A	65A/30kW	3NO		screw connection	CL07A300M6	LS30K.00A

### auxiliary contactors



pos.	order no.	supply	resistive load AC1)	electromagnetic power AC15	contacts	connection	producer-type (GE)	producer-type (AEG)
1	380843	230VAC	16A	4A	2NO/2NC	screw connection	MCRA022ATN	SH05.22A
2	380842	230VAC	16A	4A	3NO/1NC	screw connection	MCRA031ATN	SH05.31A

## accessories/auxiliary contacts



item	order no.	contacts	electromagnetic power AC15	connection	for contactors	producer-type (GE)	producer-type (AEG)
1	380683	2NO/2NC	6A	screw connection	series M series LS05	MARN422AT	HS05K.22
1	380387	3NO/1NC	6A	screw connection		MARN431AT	HS05K.31
1	380685	1NO/3NC	6A	screw connection		MARN413AT	HS05K.13
1	380242	1NO/1NC	6A	screw connection		MARN211AT	HS05K.11
2	380240	1NO	6A	screw connection		MACL110AT	HS05.10
2	380241	1NC	6A	screw connection		MACL101AT	HS05.01
3	380268	1NO	6A	screw connection	series CL series LS_K	BCLF10	HS7K.10
3	380269	1NC	6A	screw connection		BCLF01	HS7K.01
4	380270	1NO/1NC	6A	screw connection		BCLL11	HS8K.11
4	380271	2NO	6A	screw connection		BCLL20	HS8K.20

## RC circuits



item	order no.	operating voltage range	for contactors	producer-type (GE)	item	order no.	operating voltage range	for contactors	producer-type (GE)
1	381040	12–60VAC	series M	EB05A60	2	380274	12–48VAC	CL00-CL04	BSLR3G
1	380278	72–250VAC		EB05A240	2	380272	130–250VAC	CL25	BSLR2R
					2	380273	130–250VAC	CL06/CL07	BSLR3R

## overload switches



item	order no.	setting range	for contactors	producer-type (GE)	item	order no.	setting range	for contactors	producer-type (GE)	
1	380823	0,17–0,26A	series M	MT03B	3	381105	connecting block	CL00-CL04 CL25 LS4K-LS15K	MVE0T	
1	380824	0,26–0,43A		MT03C	4	381043	0,16–0,26A		RT1B	
1	380825	0,43–0,65A		MT03D	4	381044	0,25–0,41A		RT1C	
1	380826	0,65–1,0A		MT03E	4	381045	0,4–0,65A		RT1D	
1	380827	0,85–1,3A		MT03F	4	381046	0,65–1,1A		RT1F	
1	380828	1,1–1,6A		MT03G	4	381047	1,0–1,5A		RT1G	
1	380829	1,35–2,0A		MT03H	4	381048	1,3–1,9A		RT1H	
1	380830	1,7–2,4A		MT03I	4	381049	1,8–2,7A		RT1J	
1	380831	2,2–3,2A		MT03J	4	381050	2,5–4A		RT1K	
1	380832	3,0–4,7A		MT03K	4	381051	4,0–6,3A		RT1L	
1	380833	4,0–6,3A		MT03L	4	381052	5,5–8,5A		RT1M	
1	380834	5,5–8,0A		MT03M	4	381053	8,0–12A		RT1N	
1	380835	7,5–10,5A		MT03R	4	381054	10,0–16,0A		RT1P	
1	380836	10,0–14,0A		MT03P	5	381042	holder DIN rail		RTXP	
2	381041	holder DIN rail		MVB0T						

## contactors LOVATO

### motor contactors

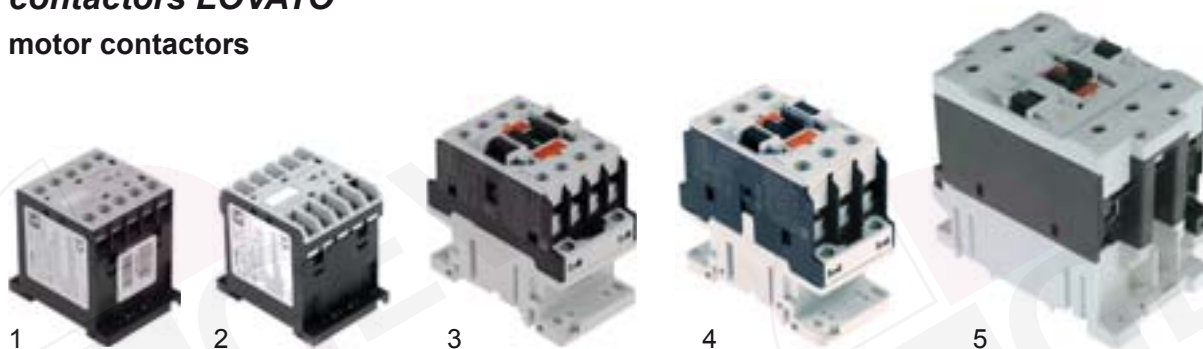

item	order no.	supply	resistive load AC1	motor performance AC3	main contacts	auxiliary contacts	connection	producer type
1	380086	230VAC	16A	5A/2,2kW	3NO	1NC	screw connection	11BG0601A230
1	380087	230VAC	16A	5A/2,2kW	3NO	1NO	screw connection	11BG0610A230
1	380704	230VAC	20A	9A/4kW	3NO	1NC	screw connection	11BG0901A230
1	380705	230VAC	20A	9A/4kW	3NO	1NO	screw connection	11BG0910A230
1	381102	24VAC	20A	9A/4kW	4NO	-	screw connection	11BG09T4A824
1	380964	230VAC	20A	9A/4kW	4NO	-	screw connection	11BG09T4A230
1	380706	230VAC	20A	9A/4kW	2NO	2NC	screw connection	11BG09T2A230
1	380707	24VAC	20A	9A/4kW	3NO	1NC	screw connection	11BG0901A024
1	380708	24VAC	20A	9A/4kW	3NO	1NO	screw connection	11BG0910A024
1	380478	24VAC	20A	9A/4kW	2NO	2NC	screw connection	11BG09T2A024
1	380709	400VAC	20A	9A/4kW	3NO	1NC	screw connection	11BG0901A400
1	380710	400VAC	20A	9A/4kW	3NO	1NO	screw connection	11BG0910A400
2	380711	230VAC	20A	9A/4kW	3NO	1NC	faston 6,3mm	11BGF0901A230
2	380712	230VAC	20A	9A/4kW	3NO	1NO	faston 6,3mm	11BGF0910A230
2	380713	230VAC	20A	9A/4kW	4NO	-	faston 6,3mm	11BGF09T4A230
2	380690	230VAC	20A	9A/4kW	2NO	2NC	faston 6,3mm	11BGF09T2A230
3	381103	24VAC	25A	9A/4,2kW	4NO	-	screw connection	11BF09T4A024
3	380083	230VAC	25A	9A/4,2kW	3NO	1NC	screw connection	11BF0901A230
3	380714	230VAC	25A	9A/4,2kW	3NO	1NO	screw connection	11BF0910A230
3	380525	230VAC	25A	9A/4,2kW	4NO	-	screw connection	11BF09T4A230
3	380715	230VAC	28A	12A/5,7kW	3NO	1NC	screw connection	11BF1201A230
3	380716	230VAC	28A	12A/5,7kW	3NO	1NO	screw connection	11BF1210A230
3	380717	230VAC	32A	18A/7,5kW	3NO	1NC	screw connection	11BF1801A230
3	380718	230VAC	32A	18A/7,5kW	3NO	1NO	screw connection	11BF1810A230
3	380788	230VAC	32A	18A/7,5kW	4NO	-	screw connection	11BF18T4A230
3	380719	230VAC	32A	25A/12,5kW	3NO	1NC	screw connection	11BF2501A230
3	380720	230VAC	32A	25A/12,5kW	3NO	1NO	screw connection	11BF2510A230
4	380721	230VAC	45A	26A/13kW	3NO	-	screw connection	11BF2600A230
4	380787	230VAC	45A	26A/13kW	4NO	-	screw connection	11BF26T4A230
4	381104	24VAC	56A	32A/16kW	3NO	-	screw connection	11BF3200A024
4	380722	230VAC	56A	32A/16kW	3NO	-	screw connection	11BF3200A230
5	380723	230VAC	90A	50A/25kW	3NO	-	screw connection	11BF5000A230

### RC circuits



item	order no.	operating voltage range	for contactors	producer-type	item	order no.	operating voltage range	for contactors	producer-type
1	380737	up to 48VAC		11BGX79048	2	380740	125-240VAC	series BF09-32	BFX79240
1	380738	125-240VAC	series BG	11BGX79240	3	380741	125-240VAC	series BF50	11G318240
1	380739	240-415VAC		11BGX79415					



## auxiliary contacts



item	order no.	contacts	resistive load AC1	connection	for contactors	producer-type
1	380724	4NO	10A	screw connection	series BG	11BGX1040
1	380725	3NO/1NC	10A	screw connection		11BGX1031
1	380726	2NO/2NC	10A	screw connection		11BGX1022
1	380727	3NC/1NO	10A	screw connection		11BGX1013
1	380728	4NC	10A	screw connection		11BGX1004
2	380729	4NO	10A	screw connection	series BF	BFX1040
2	380730	3NO/1NC	10A	screw connection		BFX1031
2	380731	2NO/2NC	10A	screw connection		BFX1022
2	380732	3NC/1NO	10A	screw connection		BFX1013
2	380733	4NC	10A	screw connection		BFX1004
3	380734	1NO	10A	screw connection		11G41810
3	380735	1NC	10A	screw connection		11G41801
4	380736	lateral mounted adapter				11G419

## overload switches

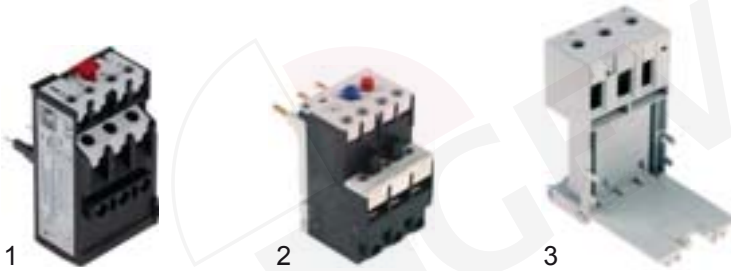

item	order no.	setting range	for contactors	producer type	item	order no.	setting range	for contactors	producer type
1	380080	0,2–0,33A	series BG	11RF9033	2	380747	0,16–0,25A	series BF	RF380025
1	380089	0,3–0,5A		11RF905	2	380748	0,25–0,4A		RF380040
1	380742	0,45–0,75A		11RF9075	2	380749	0,4–0,63A		RF380063
1	380081	0,6–1A		11RF91	2	380750	0,63–1A		RF380100
1	380743	0,9–1,5A		11RF91V5	2	380751	1–1,6A		RF380160
1	380744	1,4–2,3A		11RF92V3	2	380752	1,6–2,5A		RF380250
1	380745	2–3,3A		11RF93	2	380753	2,5–4A		RF380400
1	380670	3–5A		11RF95	2	380754	4–6,5A		RF380650
1	380746	4,5–7,5A	11RF975	2	381097	6,3–10A	RF381000		
				2	381098	9–14A	RF381400		
				2	381099	13–18A	RF381800		
				2	381100	17–23A	RF382300		
				2	381101	24–32A	RF383200		
				3	380755	holder	RFX3804		

## contactors ISKRA (FANAL)

### motor contactors



item	order no.	supply	resistive load AC1	motor performance AC3	main contacts	auxiliary contacts	connection	producer-type (Iskra)	producer-type (Fanal)
1	380546	230VAC	20A	5A/2,2KW	3NO	1NO	screw connection	K03M-10	DSL3-10
1	380547	230VAC	20A	5A/2,2KW	3NO	1NC	screw connection	K03M-10	DSL3-01
2	380213	230VAC	20A	8,5A/5,5KW	3NO	1NO	screw connection	K07M-10	DSL7-10
2	380212	230VAC	20A	8,5A/5,5KW	3NO	1NC	screw connection	K07M-01	DSL7-01
2	380214	230VAC	20A	8,5A/5,5KW	4NO		screw connection	K07M-00	DSL7-00
2	380414	400VAC	20A	8,5A/5,5KW	3NO	1NO	screw connection	K07M-10	DSL7-10
2	380413	400VAC	20A	8,5A/5,5KW	3NO	1NC	screw connection	K07M-01	DSL7-01
2	380412	24VAC	20A	8,5A/5,5KW	3NO	1NO	screw connection	K07M-10	DSL7-10
2	380411	24VAC	20A	8,5A/5,5KW	3NO	1NC	screw connection	K07M-01	DSL7-01
2	380405	12VAC	20A	8,5A/5,5KW	3NO	1NO	screw connection	K07M-10	DSL7-10
2	380406	12VAC	20A	8,5A/5,5KW	3NO	1NC	screw connection	K07M-01	DSL7-01
2	380401	12VDC	20A	8,5A/5,5KW	3NO	1NO	screw connection	K07MG-10	DGSL7-10
2	380402	12VDC	20A	8,5A/5,5KW	3NO	1NC	screw connection	K07MG-01	DGSL7-01
2	380418	24VDC	20A	8,5A/5,5KW	3NO	1NO	screw connection	K07MG-10	DGSL7-10
2	380417	24VDC	20A	8,5A/5,5KW	3NO	1NC	screw connection	K07MG-01	DGSL7-01
3	380416	230VAC	20A	8,5A/5,5KW	3NO	1NO	faston 6,3mm	K07MF-10	DSL7-10/F6
3	380415	230VAC	20A	8,5A/5,5KW	3NO	1NC	faston 6,3mm	K07MF-01	DSL7-01/F6
4	380204	230VAC	25A	8,5A/4KW	3NO	1NO	screw connection	KNL9-10	DSL9-10
4	380203	230VAC	25A	8,5A/4KW	3NO	1NC	screw connection	KNL9-01	DSL9-01
4	380422	400VAC	25A	8,5A/4KW	3NO	1NO	screw connection	KNL9-10	DSL9-10
4	380421	400VAC	25A	8,5A/4KW	3NO	1NC	screw connection	KNL9-01	DSL9-01
4	380420	24VAC	25A	8,5A/4KW	3NO	1NO	screw connection	KNL9-10	DSL9-10
4	380419	24VAC	25A	8,5A/4KW	3NO	1NC	screw connection	KNL9-01	DSL9-01
5	380224	230VAC	25A	17A/7,5KW	3NO	1NO	screw connection	KNL16-10	DSL16-10
5	380219	230VAC	25A	17A/7,5KW	3NO	1NC	screw connection	KNL16-01	DSL16-01
6	380423	230VAC	35A	25A/11KW	3NO		screw connection	KNL22	DSL22
6	380424	230VAC	35A	32A/15KW	3NO		screw connection	KNL30	DSL30
7	380697	230VAC	75A	40A/18,5KW	3NO	1NO/1NC	screw connection	KNL40	DSL43-11
7	380693	230VAC	85A	65A/30KW	3NO	1NO/1NC	screw connection	KNL65	DSL63-11

### auxiliary contactors



item	order no.	supply	resistive load AC1	electromagnetic power AC15	contacts	connection	producer-type (Iskra)	producer-type (Fanal)
1	380253	230VAC	20A	4A	2NO/2NC	screw connection	K03C-22	DSL3-22
1	380205	230VAC	20A	4A	4NO	screw connection	K03C-40	DSL3-40
2	380206	230VAC	20A	4A	3NO/1NC	screw connection	K07C-31	DSL7-31
2	380207	230VAC	20A	4A	2NO/2NC	screw connection	K07C-22	DSL7-22
3	380208	230VAC	16A	4A	2NO/2NC	faston 6,3mm	K07CF-22	DSL7-22/F6
4	380200	230VAC	20A	4A	3NO/1NC	screw connection	KNL6-22	DSL6-22
4	380201	230VAC	20A	4A	4NO	screw connection	KNL6-40	DSL6-40

## auxiliary contacts



item	order no.	contacts	electromagnetic power AC15	connection	for contactors	producer-type (Iskra)	producer-type (Fanal)
1	380228	2NO/2NC	4A	screw connection		ND4M-22	SM4-22
1	380229	3NO/1NC	4A	screw connection	K03M/K07M	ND4M-31	SM4-31
1	380227	1NO/3NC	4A	screw connection		ND4M-13	SM4-13
2	380225	3NO/1NC	4A	screw connection		ND4C-31	SC4-31
2	380226	2NO/2NC	4A	screw connection	K03C/K07C	ND4C-22	SC4-22
2	380429	4NO	4A	screw connection		ND4C-40	SC4-40
3	380199	3NO/1NC	4A	screw connection	KNL9/KN16	NDL2-31	SF2-31
3	380426	2NO/2NC	4A	screw connection		NDL2-22	SF2-22
4	380427	3NO/1NC	4A	screw connection		NDL3-31	
4	380428	2NO/2NC	4A	screw connection	KNL22/KNL30	NDL3-22	
5	381055	3NO/1NC	4A	screw connection		NDL5-31	
5	381056	2NO/2NC	4A	screw connection	KNL40/KNL65	NDL5-22	
6	381057	1NO	4A	screw connection	KNL9/KN16	NPL1-10	
6	381058	1NC	4A	screw connection		NPL1-01	
6	381059	1NO	4A	screw connection		NPL2-10	
6	381060	1NC	4A	screw connection	KNL22/KNL30	NPL2-01	

## RC circuits



item	order no.	operating voltage range	for contactors	producer-type (Iskra)	item	order no.	operating voltage range	for contactors	producer-type (Iskra)
1	380431	24–48VAC	KNL6-30	RC1	3	380433	380–500VAC	KNL6-30	RC4
2	380432	48–250VAC		RC2	4	380434	110–250VAC	KNL40-65	W-RC240

## overload switches

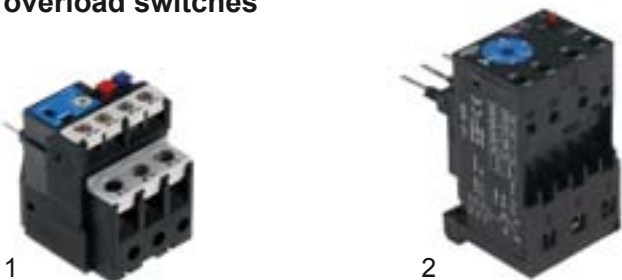

item	order no.	setting range	for contactors	producer-type (Iskra)	item	order no.	setting range	for contactors	producer-type (Iskra)
1	380436	1–1,5A		BR6 1-1,5A	2	380462	1,5–2,5A		TRB14 1,5-2,5A
1	380437	1,4–2,1A		BR6 1,4-2,1A	2	380451	2,5–4A		TRB14 2,5-4A
1	380438	1,8–2,7A	K03C	BR6 1,8-2,7A	2	380463	3,8–6,3A	KNL6-30	TRB14 3,8-6,3A
1	380439	2,4–3,6A	K03M	BR6 2,4-3,6A	2	380453	6–10A		TRB14 6-10A
1	380440	3,5–5A	K07C	BR6 3,5-5A	2	380454	9,6–16A		TRB14 9,6-16A
1	380442	5,5–8,5A	K07M	BR6 5,5-8,5A	2	380455	15–25A		TRB14 15-25A
1	380443	8,5A–11A		BR6 8,5A-11A					

## contactors SIEMENS

### motor contactors



item	order no.	supply	resistive load AC1	motor performance AC3	main contacts	auxiliary contacts	connection	producer-type
1	381061	230VAC	16A	9A/4kW	3NO	1NO	screw connection	3TF2010-0AL2
1	381062	230VAC	16A	9A/4kW	3NO	1NC	screw connection	3TF2001-0AL2
2	381063	230VAC	16A	9A/4kW	3NO	1NO	faston 6,3mm	3TF2010-3AL2
2	380696	230VAC	16A	9A/4kW	3NO	1NC	faston 6,3mm	3TF2001-3AL2
3	380526	230VAC	20A	8,4A/4kW	4NO		screw connection	3TG1010-0AL2
3	380527	230VAC	20A	8,4A/4kW	3NO	1NC	screw connection	3TG1001-0AL2
4	380528	230VAC	16A	8,4A/4kW	4NO		faston 6,3mm	3TG1010-1AL2
4	380529	230VAC	16A	8,4A/4kW	3NO	1NC	faston 6,3mm	3TG1001-1AL2
5	380389	230VAC	22A	9A/4kW	3NO	1NO	screw connection	3RT1016-1AL21
5	380652	230VAC	22A	9A/4kW	3NO	1NC	screw connection	3RT1016-1AL22
6	380614	230VAC	2A	9A/4kW	3NO	1NO	spring terminals	3RT1016-2AL21
7	380383	230VAC	40A	9A/4kW	3NO		screw connection	3RT1023-1AL20
7	380390	230VAC	40A	12A/5,5kW	3NO		screw connection	3RT1024-1AL20
7	380646	230VAC	40A	17A/7,5kW	3NO		screw connection	3RT1025-1AL20
7	380509	230VAC	40A	25A/11kW	3NO		screw connection	3RT1026-1AL20
8	380524	230VAC	50A	32A/15kW	3NO		screw connection	3RT1034-1AL20
8	380530	230VAC	60A	40A/18,5kW	3NO		screw connection	3RT1035-1AL20

### auxiliary contacts



item	order no.	contacts	resistive load AC1	electromagnetic power AC15	connection	for contactors	producer-type
1	381064	2NO/2NC	10A	3A	screw connection		3TX4422-2A
1	381065	3NO/1NC	10A	3A	screw connection	3TF	3TX4431-2A
1	381066	4NO	10A	3A	screw connection		3TX4440-2A
2	380531	2NO/2NC	10A	3A	screw connection		3RH1911-1FA22
2	380533	3NO/1NC	10A	3A	screw connection	3RT101	3RH1911-1FA31
2	380532	4NO	10A	3A	screw connection		3RH1911-1FA40
3	380535	2NO/2NC	10A	3A	screw connection		3RH1921-1FA22
3	380537	3NO/1NC	10A	3A	screw connection		3RH1921-1FA31
3	380536	4NO	10A	3A	screw connection		3RH1921-1FA40
3	380538	4NC	10A	3A	screw connection	3RT102 3RT103	3RH1921-1FA04
4	380539	1NO	10A	3A	screw connection		3RH1921-1CA10
4	380540	1NC	10A	3A	screw connection		3RH1921-1CA01
5	380647	1NO/1NC	10A	3A	screw connection		3RH1921-1EA11

## overload switches



item	order no.	setting range	for contactors	producer-type	item	order no.	setting range	for contactors	producer-type
1	381067	0,18–0,25A	3RT101	3RU1116-0CB0	2	381072	1,8–2,5A	3RT102	3RU1126-1CB0
1	380655	0,28–0,4A		3RU1116-0EB0	2	381073	2,8–4,0A		3RU1126-1EB0
1	381068	0,45–0,63A		3RU1116-0GB0	2	381074	3,5–5,0A		3RU1126-1FB0
1	380659	0,7–1,0A		3RU1116-0JB0	2	381075	4,5–6,3A		3RU1126-1GB0
1	381069	1,1–1,6A		3RU1116-1AB0	2	381076	5,5–8,0A		3RU1126-1HB0
1	380661	1,4–2,0A		3RU1116-1BB0	2	381077	7,0–10,0A		3RU1126-1JB0
1	380657	1,8–2,5A		3RU1116-1CB0	2	381078	9,0–12,5A		3RU1126-1KB0
1	381070	2,8–4,0A		3RU1116-1EB0					
1	381071	3,5–5,0A		3RU1116-1FB0					

### motor contactors



item	order no.	supply	resistive load AC1	motor performance AC3	main contacts	auxiliary contacts	connection	producer-type
1	380983	230VAC	20A	5A/2,2kW	2NO		screw connection	LC1SKGC200P7
2	380965	230VAC	20A	6A/2,2kW	3NO	1NO	screw connection	LC1K0610P7
2	380966	230VAC	20A	6A/2,2kW	3NO	1NC	screw connection	LC1K0601P7
2	380967	230VAC	20A	9A/4kW	3NO	1NO	screw connection	LC1K0910P7
2	380968	230VAC	20A	9A/4kW	3NO	1NC	screw connection	LC1K0901P7
2	380969	230VAC	20A	9A/4kW	2NO/2NC		screw connection	LC1K09008P7
2	380970	230VAC	20A	12A/5,5kW	3NO	1NO	screw connection	LC1K1210P7
2	380971	230VAC	20A	12A/5,5kW	3NO	1NC	screw connection	LC1K1201P7
2	380972	230VAC	20A	12A/5,5kW	4NO		screw connection	LC1K12004P7
2	380973	230VAC	20A	16A/7,5kW	3NO		screw connection	LC1K1610P7
3	381010	230VAC	20A	6A/2,2kW	2x3NO	2x1NO	screw connection	LC2K0610P7
3	380984	230VAC	20A	12A/5,5kW	2x3NO	2x1NO	screw connection	LC2K1210P7
3	380985	230VAC	20A	12A/5,5kW	2x3NO	2x1NC	screw connection	LC2K1201P7
4	380974	230VAC	20A	9A/4kW	3NO	1NO	faston 6,3mm	LC1K09107P7
4	380975	230VAC	20A	9A/4kW	3NO	1NC	faston 6,3mm	LC1K09017P7
5	380479	230VAC	25A	9A/4kW	3NO	1NO/1NC	screw connection	LC1D09P7
5	380617	24VAC	25A	9A/4kW	3NO	1NO/1NC	screw connection	LC1D09B7
5	380976	230VAC	32A	18A/7,5kW	3NO	1NO/1NC	screw connection	LC1D18P7
6	380698	230VAC	20A	12A/5,5kW	3NO	1NO/1NC	spring terminals	LC1D123P7
7	380977	230VAC	20A	9A/4kW	4NO	1NO/1NC	screw connection	LC1DT20P7
7	380978	230VAC	20A	9A/4kW	2NO/2NC	1NO/1NC	screw connection	LC1D098P7
7	380979	230VAC	40A	25A/11kW	3NO	1NO/1NC	screw connection	LC1D25P7
7	380090	230VAC	40A	25A/11kW	4NO	1NO/1NC	screw connection	LC1DT25P7
7	380980	230VAC	50A	32A/15kW	3NO	1NO/1NC	screw connection	LC1D32P7
8	380981	230VAC	60A	40A/18,5kW	3NO	1NO/1NC	screw connection	LC1D40P7
8	380982	230VAC	80A	50A/22kW	3NO	1NO/1NC	screw connection	LC1D50P7

### auxiliary contactors



pos.	order no.	supply	resistive load AC1	electromagnetic power AC15	contacts	connection	producer-type
1	380367	230VAC	10A		1NO/1NC	screw connection	CA2SK11P7

## auxiliary contacts



item	order no.	contacts	resistive load AC1	connection	for contactors	producer-type
1	380986	4NO	10A	screw connection	series LC1K	LA1KN40
1	380987	3NO/1NC	10A	screw connection		LA1KN31
1	380988	2NO/2NC	10A	screw connection		LA1KN22
1	380989	3NC/1NO	10A	screw connection		LA1KN13
1	380990	4NC	10A	screw connection		LA1KN04
2	380991	4NO	10A	screw connection	series LC1D	LADN40
2	380992	3NO/1NC	10A	screw connection		LADN31
2	380993	2NO/2NC	10A	screw connection		LADN22
2	380994	3NC/1NO	10A	screw connection		LADN13
2	380995	4NC	10A	screw connection		LADN04
3	380996	1NO/1NC	10A	screw connection		LAD8N11
3	380997	2NO	10A	screw connection		LAD8N20

## overload switches

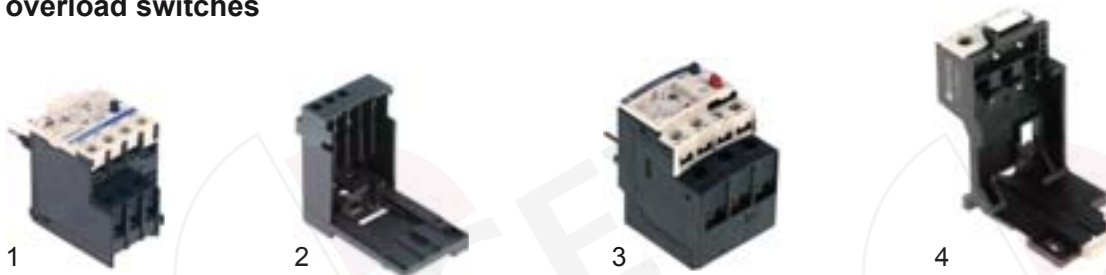

item	order no.	setting range	for contactors	producer type	item	order no.	setting range	for contactors	producer type
1	380756	0,36–0,54A	LC1K	LR2K0304	3	380762	0,25–0,40A	LC1D	LRD03
1	380757	0,54–0,8A		LR2K0305	3	380763	0,40–0,63A		LRD04
1	380758	0,8–1,2A		LR2K0306	3	380764	0,63–1A		LRD05
1	380759	1,2–1,8A		LR2K0307	3	380765	1–1,7A		LRD06
1	380450	1,8–2,6A		LR2K0308	3	380766	1,6–2,5A		LRD07
1	380760	2,6–3,7A		LR2K0310	3	380619	2,5–4A		LRD08
1	380452	3,7–5,5A		LR2K0312	3	380620	4–6A		LRD10
1	380761	5,5–8A		LR2K0314	3	380621	5,5–8A		LRD12
2	380768	holder		LA7K0064	3	380767	7–10A		LRD14
					4	380769	holder		LA7D1064

## contactors **BENEDIKT & JÄGER** motor contactors

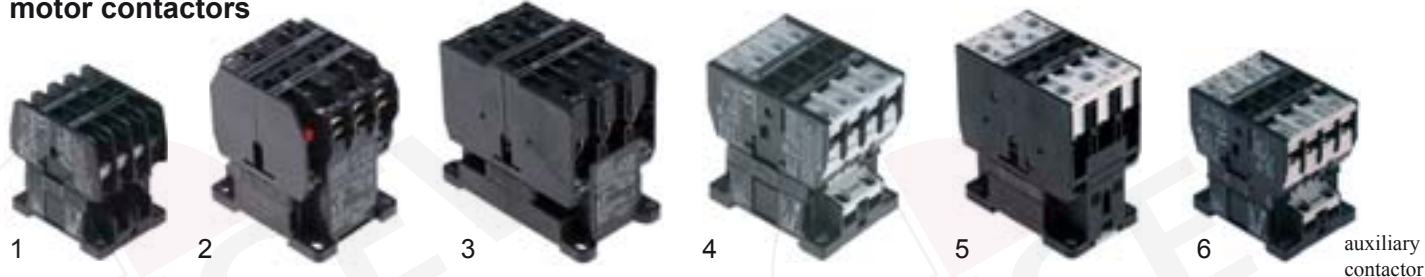

item	order no.	supply	resistive load AC1	motor performance AC3	main contacts	auxiliary contacts	connection	producer-type
1	380665	230VAC	25A	10A/4kW	3NO	1NO	screw connection	K2-09A10230
1	380672	230VAC	25A	10A/4kW	3NO	1NC	screw connection	K2-09A01230
1	380679	230VAC	25A	12A/5,5kW	3NO	1NO	screw connection	K2-12A10230
1	380675	230VAC	25A	12A/5,5kW	3NO	1NC	screw connection	K2-12A01230
1	380778	24VAC	25A	12A/5,5kW	3NO	1NO	screw connection	K2-12A1024
1	380674	230VAC	25A	12A/5,5kW	4NO		screw connection	K2-12A00-40230
1	381079	230VAC	25A	16A/7,5kW	3NO	1NO	screw connection	K2-16A10230
1	381080	230VAC	25A	16A/7,5kW	3NO	1NC	screw connection	K2-16A01230
2	380637	230VAC	45A	23A/11kW	3NO	1NO	screw connection	K2-23A10230
2	380673	230VAC	45A	23A/11kW	3NO	1NC	screw connection	K2-23A01230
2	380780	24VAC	45A	23A/11kW	3NO	1NO	screw connection	K2-23A1024
2	380521	230VAC	45A	23A/11kW	4NO		screw connection	K2-23A00-40230
2	380771	230VAC	50A	30A/15kW	3NO	1NO	screw connection	K2-30A10230
2	381081	230VAC	50A	30A/15kW	3NO	1NC	screw connection	K2-30A01230
3	380676	230VAC	80A	45A/22kW	3NO		screw connection	K2-45A00230
4	380772	230VAC	25A	10A/4kW	3NO	1NO	screw connection	K3-10A10230
4	380395	230VAC	25A	10A/4kW	3NO	1NC	screw connection	K3-10A01230
4	381082	230VAC	25A	14A/5,5kW	3NO	1NO	screw connection	K3-14A10230
4	381083	230VAC	25A	14A/5,5kW	3NO	1NC	screw connection	K3-14A01230
4	380779	24VAC	25A	14A/5,5kW	3NO	1NO	screw connection	K3-14A1024
4	381084	230VAC	25A	14A/5,5kW	4NO		screw connection	K3-14A00-40230
4	380774	230VAC	32A	18A/7,5kW	3NO	1NO	screw connection	K3-18A10230
4	380790	230VAC	32A	18A/7,5kW	3NO	1NC	screw connection	K3-18A01230
5	381085	230VAC	50A	24A/11kW	3NO		screw connection	K3-24A00230
5	380775	230VAC	65A	32A/15kW	3NO		screw connection	K3-32A00230
5	380776	230VAC	80A	40A/18,5kW	3NO		screw connection	K3-40A00230
6	380777	230VAC	20A		4NO		screw connection	K2-07A40230

### auxiliary contacts



item	order no.	contacts	AC1	connection	for contactors	producer-type
1	380678	1NO	10A	screw connection	K2/K3	HN10
1	380677	1NC	10A	screw connection		HN01
2	380781	1NO	25A	screw connection	K2/K5	HA10
2	381086	1NC	25A	screw connection		HA01



## contactors diverse

### motor contactors



item	order no.	supply	resistive load AC1	motor performance AC3	main contacts	auxiliary contacts	connection	producer	producer-type
1	380852	230VAC	20A	9A/4KW	3NO	1NO	screw connection	Ghisalba	GHMC.3.10
2	380360	230VAC	20A	9A/4KW	3NO	1NO	screw connection	Allen-Bradley	100-M09N*3
2	380522	230VAC	20A	12A/5,5KW	3NO	1NC	screw connection	Allen-Bradley	100-M12N*3
2	380571	230VAC	20A	12A/5,5KW	3NO	1NC	screw connection	Allen-Bradley	100-M12N*31
3	380548	230VAC	25A	9A/4KW	3NO	1NC	screw connection	Fantini	HR0901NU
4	380352	230VAC	32A	9A/4KW	4NO		screw connection	Allen-Bradley	100C09*400
5	380391	230VAC	110A	55A/30KW	3NO		screw connection	Fantini	HR055NU

### small relay switches Tripus (Eichhoff)



item	order no.	supply	resistive load AC1	contacts	connection	producer-type
1	380397	24VDC	16A	1NO/1NC	faston 6,3mm	E3250
2	380119	230VAC	16A	2NO/2NC	faston 6,3mm	E3250
2	380120	230VAC	16A	4NO	faston 6,3mm	E3250
2	380121	230VAC	16A	3NO/1NC	faston 6,3mm	E3250

### installation contactors



item	order no.	supply	resistive load AC1	motor performance AC3	contacts
1	380250	230VAC	20A	1,5kW	3NO/1NO
1	380251	230VAC	20A	1,5kW	3NO/1NC
2	380255	230VAC	20A	1,3kW	2NO
2	380256	230VAC	20A	1,3kW	1NO/1NC
3	380254	230VAC	25A	2,2kW	2NO/2NC
3	380257	230VAC	25A	2,2kW	4NO
3	380258	230VAC	25A	2,2kW	3NO/1NC
4	380259	230VAC	40A	5,5kW	4NO
4	380252	230VAC	40A	5,5kW	3NO/1NC
4	380260	230VAC	63A	8,5kW	4NO
4	380275	230VAC	63A	8,5kW	3NO/1NC
5	380198	auxiliary contact			1NO/1NC

## motor protective circuit breaker

©GEV 2008



item	order no.	setting range	motor performance AC3 (400V)	contacts	item	order no.	setting range	motor performance AC3 (400V)	contacts
1	380359	0,63–1,0A	0,25KW	-	2	380305	-	-	1NO/1NC
1	380300	1,0–1,6A	0,55KW	-	2	380369	-	-	1NO
1	380301	1,6–2,5A	1,1KW	-	2	380370	-	-	2NO
1	380302	2,5–4,0A	1,5KW	-	2	380371	-	-	1NC
1	380303	4,0–6,3A	3KW	-	2	380372	-	-	2NC
1	380304	6,3–10,0A	4KW	-	3	380541	0,07–1,0A	0,25KW	-
1	380338	10,0–16,0A	9KW	-	3	380542	1,8–2,5A	0,75KW	-
1	380339	16,0–20,0A	11KW	-	3	380543	2,8–4A	1,5KW	-
1	380344	20,0–25,0A	12,5KW	-	3	380544	4,5–6,3A	2,2KW	-
					4	380545	-	-	1NO/1NC

## relays

### print relays

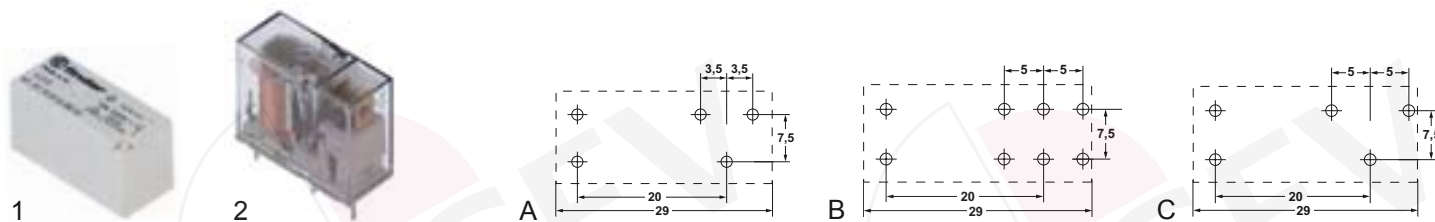

item	order no.	supply	contacts	switch power	comparison-type Finder	comparison-type Italiana Rele
1A	380634	12VDC	1CO	12A/250V	41.31.9.012	F15-12DC-S
1A	381111	24VDC	1CO	12A/250V	41.31.9.024	
1A	380791	230VAC	1CO	12A/250V	41.31.8.230	F15-230AC-S
1B	380792	12VDC	1CO	16A/250V	41.61.9.012	
1B	380793	230VAC	1CO	16A/250V	41.61.8.230	
1B	380500	12VDC	2CO	8A/250V	41.52.9.012	
1B	380488	230VAC	2CO	8A/250V	41.52.8.230	
2A	380795	12VDC	1CO	10A/250V	40.31.9.012	E31-12DC-S
2A	380796	24VDC	1CO	10A/250V	40.31.9.024	E31-24DC-S
2A	380797	230VAC	1CO	10A/250V	40.31.8.230	E31-230AC-S
2C	380798	12VDC	1CO	10A/250V	40.51.9.012	E51-12DC-S
2C	380331	24VAC	1CO	10A/250V	40.51.8.024	E51-24AC-S
2C	380334	230VAC	1CO	10A/250V	40.51.8.230	E51-230AC-S
2B	380348	12VDC	1CO	16A/250V	40.61.9.012	E61-12DC-S
2B	380633	24VDC	1CO	16A/250V	40.61.9.024	E61-24DC-S
2B	380853	24VAC	1CO	16A/250V	40.61.8.024	
2B	380335	230VAC	1CO	16A/250V	40.61.8.230	E61-230AC-S
2B	380794	12VDC	2CO	8A/250V	40.52.9.012	E52-12DC-S
2B	380349	24VDC	2CO	8A/250V	40.52.9.024	E52-24DC-S
2B	380333	230VAC	2CO	8A/250V	40.52.8.230	E52-230AC-S

Contactor, relays, semiconductor relays C

## accessories print relays

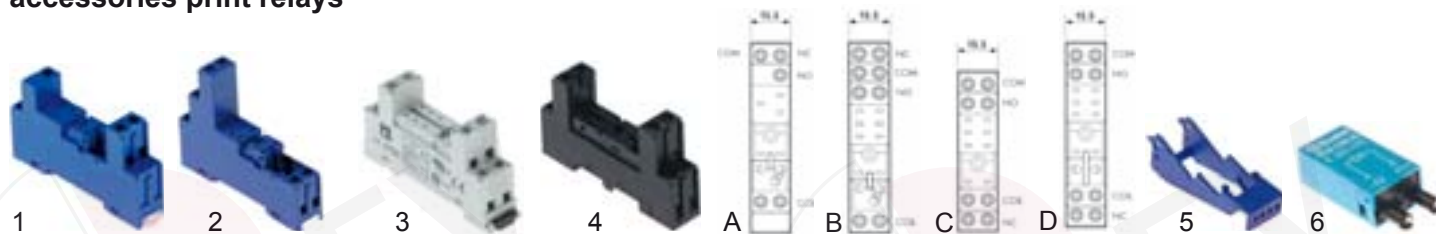

item	order no.	description	raster	item	order no.	description	voltage
1A	380663	socket	3,5	5	380506	support bracket	
2B	380505	socket	5,0	6	380507	suppressor diode	6-220VDC
3C	380340	socket	5,0	6	380799	remote control module	6-24VDC/AC
4D	380487	socket	5,0	6	380800	remote control module	110-240VDC/AC

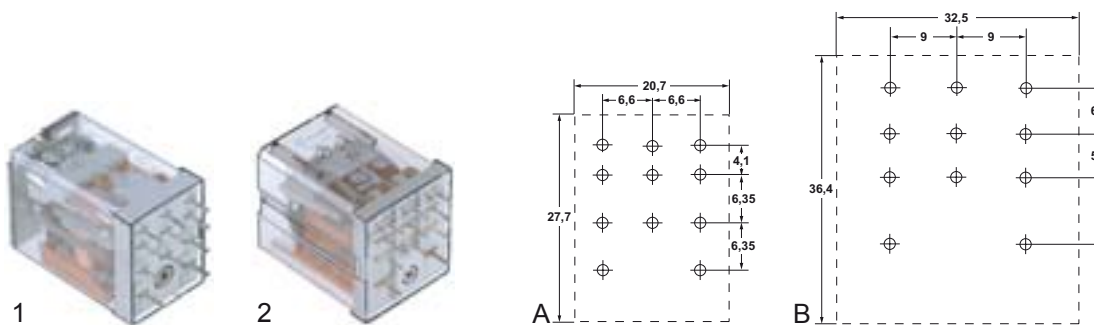

item	order no.	supply	contacts	switch power	comparison-type Finder
1A	381107	24VAC	3CO	10A/250V	55.13.8.024.0000
2B	381108	24VAC	3CO	10A/250V	60.43.8.024.0000

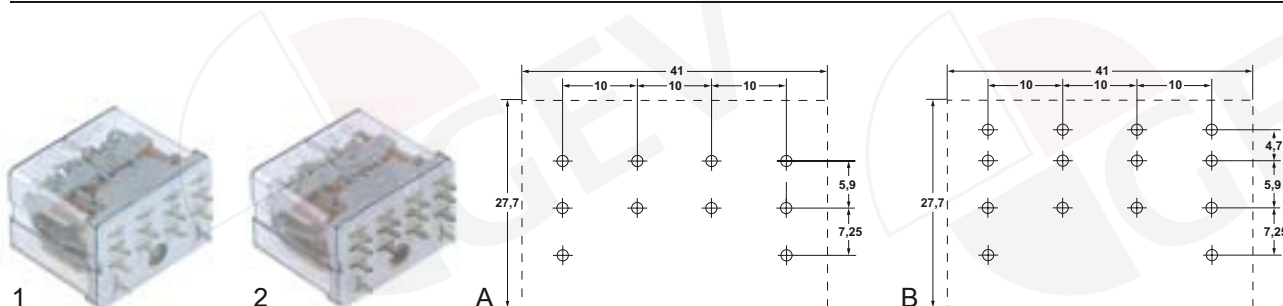

item	order no.	supply	contacts	switch power	comparison-type Finder
1A	381109	24VAC	4NO	12A/250V	56.44.8.230
2B	381110	230VAC	4CO	12A/250V	56.44.8.230.0000

## plug-in relays

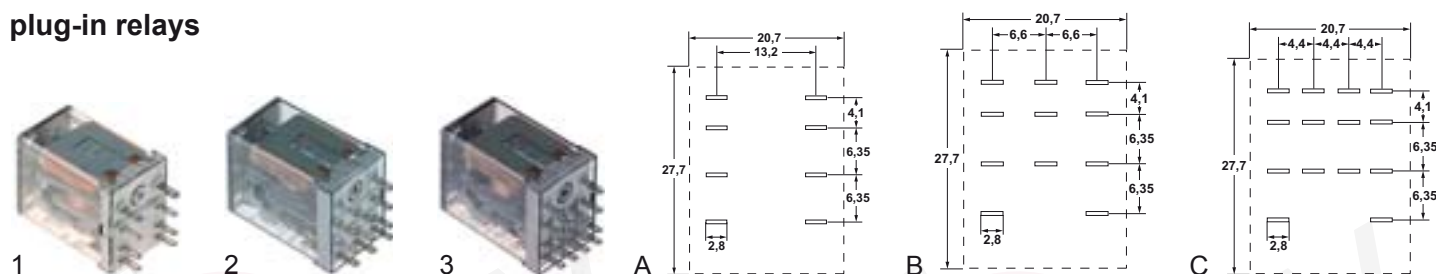

item	order no.	supply	contacts	switch power	faston (mm)	comparison-type Finder	comparison-type Italiana Rele
1A	380382	230VAC	1CO	16A/250V	2,8	55.31.8.230.0000	D1N-230AC
1A	380129	24VAC	2CO	12A/250V	2,8	55.32.8.024.0040	D2N-024AC
1A	380377	230VAC	2CO	10A/250V	2,8	55.32.8.230.0054	D2N-230AC
2B	380362	230VAC	3CO	10A/250V	2,8	55.33.8.230.0010	D3N-230AC
3C	380504	230VAC	4CO	7A/250V	2,8	55.34.8.230.0000	D4N-230AC
3C	380494	230VAC	4CO	7A/250V	2,8	55.34.8.230.0054	D4N-230AC

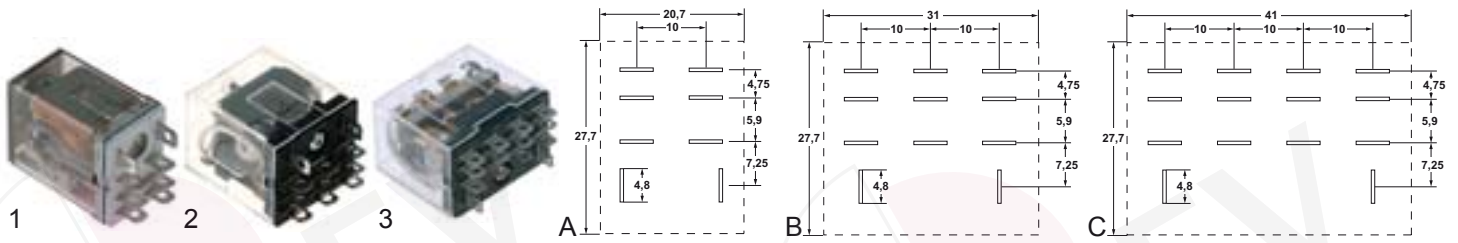

item	order no.	supply	contacts	switch power	faston (mm)	comparison-type
1A	380475	230VAC	2CO	12A/250V	4,8	Finder Italiana Rele 56.32.8.230.0040 D6N-230AC
2B	380355	230VAC	3CO	10A/250V	4,8	Omron LY3
3C	381106	24VAC	4CO	10A/250V	4,8	Omron LY4 56.34.8.024.0000

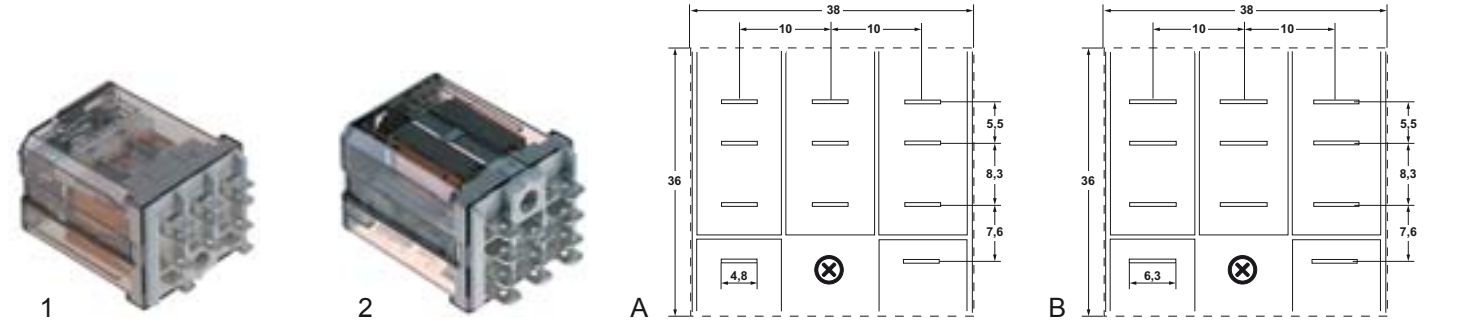

item	order no.	supply	contacts	switch power	faston (mm)	comparison-type
1A	380854	24VAC	3CO	16A/250V	4,8	Finder 62.33.8.024.0000
1A	380143	230VAC	3CO	16A/250V	4,8	Finder 62.33.8.230.0040
2B	381004	230VAC	3CO	16A/250V	6,3	Finder 62.83.8.230.4009

## accessories plug-in relay

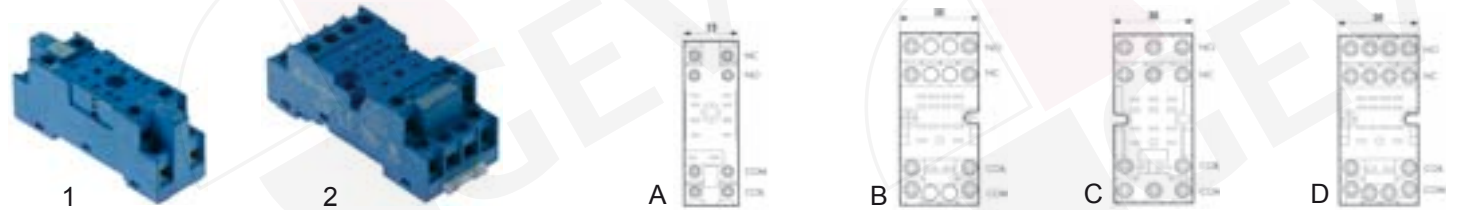

item	order no.	description	overall width (mm)	faston (mm)	series	item	order no.	description	overall width (mm)	faston (mm)	series
1A	380384	socket	23	2,8	55.31 55.32	2C	380801	socket	30	2,8	55.33
2B	380378	socket	30	2,8	55.31 55.32	2D	380802	socket	30	2,8	55.31 55.32 55.34

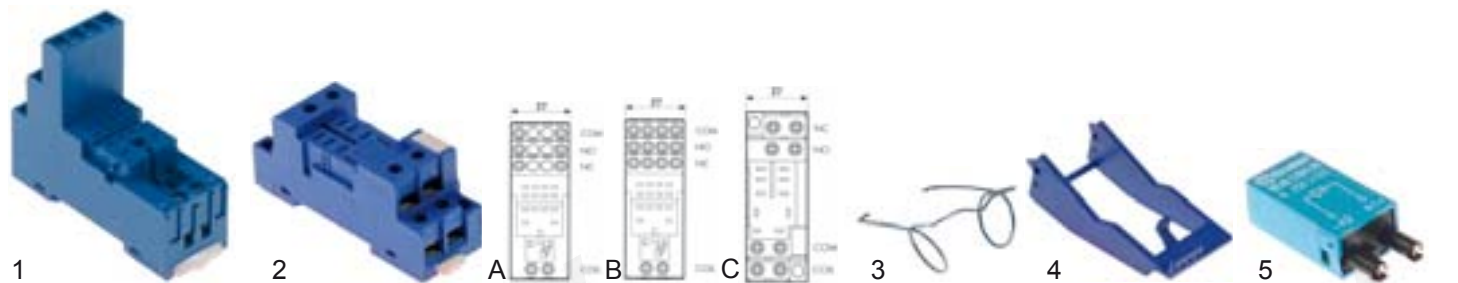

item	order no.	description	overall width (mm)	faston (mm)	series	item	order no.	description	voltage
1A	380803	socket	27	2,8	55.31 55.32	5	380507	suppressor diode	6-220VDC
1B	380399	socket	27	2,8	55.31 55.32 55.34	5	380799	remote control module	6-24VDC/AC
2C	380476	socket	27	4,8	56.32	5	380800	remote control module	110-240VDC/AC
3	380804	support bracket	23-30						
4	380503	support bracket	27-30						

## plug-in relays (pins)



item	order no.	supply	contacts	switch power	base	comparison-type Finder	comparison-type Italiana Rele
1	380135	24VAC	2CO	10A/250V	8-pole	60.12.8.024.0040	C42-024AC
1	380134	230VAC	2CO	10A/250V	8-pole	60.12.8.230.0040	C42-230AC
2	380133	24VAC	3CO	10A/250V	11-pole	60.13.8.024.0040	C43-024AC
2	380132	230VAC	3CO	10A/250V	11-pole	60.13.8.230.0040	C43-230AC
3	380137	base			8-pole		
4	380136	base			11-pole		
5	380638	base			8-pole		
6	380667	base			11-pole		
7	380805	support bracket					

## relays with bracket mounting



item	order no.	supply	contacts	switch power	faston (mm)	hole distance (mm)	comparison-type Finder	comparison-type Italiana Rele
1	380365	230VAC	2CO	12A/250V	4,8	42	56.32.8.230.0006	D6N-230AC
2	380471	230VAC	2CO	12A/250V	4,8	39	56.32.8.230.0005	D6N-230AC
3	380626	230VAC	2CO	10A/250V	4,8	52	60.62.8.230.0000	C12-230AC
4	380636	24VAC	3CO	10A/250V	4,8	52	60.63.8.024.0000	C13-024AC
4	380312	230VAC	3CO	10A/250V	4,8	52	60.63.8.230.0000	C13-230AC



item	order no.	supply	contacts	switch power	faston (mm)	hole distance (mm)	comparison-type	
1	380815	230VAC	2NO	16A/250V	6,3	63	Finder	62.82.8.230.0300
2	380138	24VAC	2CO	16A/250V	6,3	63	Finder	62.82.8.024.0040
2	380861	24VDC	2CO	16A/250V	6,3	63	Finder Magnecraft	62.82.9.024.0000 389CX-179
2	380139	230VAC	2CO	16A/250V	6,3	63	Finder	62.82.8.230.0000
3	380702	230VAC	3NO	16A/250V	6,3	63	Finder	62.83.8.230.0300
4	380400	12VDC	3CO	16A/250V	6,3	63	Finder	62.83.9.012.0500
4	380404	24VAC	3CO	16A/250V	6,3	63	Finder	62.83.8.024.0500
4	380860	24VDC	3CO	16A/250V	7,3	63	Finder Magnecraft	62.83.9.024.0000 389CX-178
4	380808	230VAC	3CO	16A/250V	6,3	63	Finder	62.83.8.230.0000
5	380627	230VAC	3CO	16A/250V	6,3	52	Finder	62.82.8.230.0005
6	380185	230VAC	1NO	30A/250V	6,3	52	Finder Italiana Rele	65.31.8.230.0300 A10.230AC-FA
7	380311	230VAC	1NO/1NC	20A/250V	6,3	52	Finder Italiana Rele	65.31.8.230.0000 A1B-230AC-FA



item	order no.	supply	contacts	switch power	faston (mm)	hole distance (mm)	comparison-type
1	380687	230VAC	2NO	30A/250V	6,3	59,5	Finder 66.82.8.230.1300
2	380812	230VAC	2CO	30A/250V	6,3	59,5	Finder 66.82.8.230.0000
3	380307	230VAC	1CO	30A/250V	coil 4,8 contacts 6,3	45	Zettler AZ2280-1C--240AF
4	380368	230VAC	1NO	30A/250V	coil 4,8 contacts 6,3	45	Zettler AZ2280-1A--240AF
5	380316	230VAC	1NO	30A/250V	6,3	40	Matsushita HE1aN-AC240V
6	381014	230VAC	1NO	25A/250V	6,3	40	Matsushita JQX-116F-2
7	380375	230VAC	2NO	16A/250V	6,3		Schrack 0415 04 004 000
8	380222	230VAC	2NO	16A/250V	6,3		Schrack 0415 04 004 000

## relays with DIN rail mounting



item	order no.	supply	contacts	switch power	faston (mm)	comparison-type
1	380183	230VAC	2CO	12A/250V	4,8	Finder Italiana Rele 56.32.8.230.0007 D6N-230AC
2	380196	230VAC	4CO	12A/250V	4,8	Finder Italiana Rele 56.34.8.230.0007 D8N-230AC
3	380809	230VAC	2CO	16A/250V	6,3	Finder 62.83.8.230.0307
4	380182	12VDC	3CO	16A/250V	6,3	Finder 62.83.9.012.0007
4	380181	24VAC	3CO	16A/250V	6,3	Finder 62.83.8.024.0007
4	380180	230VAC	3CO	16A/250V	6,3	Finder 62.83.8.230.0007
5	380314	230VAC	1NO/1NC	20A/250V	6,3	Finder Italiana Rele 65.31.8.230.0007 A1B-230AC-AD
6	380330	230VAC	2CO	16A/250V	6,3	Italiana Rele A2S-230AC-AD
7	380814	230VAC	2CO	30A/250V	6,3	Finder 66.82.8.230.0007



item	order no.	supply	contacts	switch power	faston (mm)	comparison-type
1	380701	230VAC	2CO	16A/250V	4,8	Finder 62.32.8.230.0008
2	380629	24VAC	3CO	16A/250V	4,8	Finder 62.33.8.024.0008
2	380807	230VAC	3CO	16A/250V	4,8	Finder 62.33.8.230.0008
3	380336	230VAC	2NO	16A/250V	6,3	Finder 62.82.8.230.0308
4	380379	230VAC	2CO	25A/250V	6,3	Schrack RM809730
5	380313	230VAC	3CO	16A/250V	6,3	Finder 62.83.8.230.0008
6	380376	230 VAC	1NO	30A/250V	6,3	Finder Italiana Rele 65.31.8.230.0308 A10-230AC

## relays with flange mounting



item	order no.	supply	contacts	switch power	faston (mm)	comparison-type
1	380357	230VAC	3NO	16A/250V	6,3	Finder 65.13.8.230.0304
2	380474	230VAC	3NC	16A/250V	6,3	Finder 65.13.8.230.0004
3	380315	230VAC	2NO	16A/250V	6,3	Feme REP200
4	380310	230VAC	2NC	16A/250V	6,3	Feme REP002
5	380817	230VAC	2NO	16A/250V	6,3	Finder Italiana Rele 65.12.8.230.0304 B1-2 230AC
6	380189	230VAC	2CO	16A/250V	6,3	Finder Italiana Rele 65.12.8.230.0004 B2-2-230AC
7	380130	230VAC	3NO	16A/250V	6,3	Finder Italiana Rele 65.13.8.230.0304 B1-3-230AC
8	380131	230VAC	3CO	16A/250V	6,3	Finder Italiana Rele 65.13.8.230.0004 B2-3-230AC

## relays various

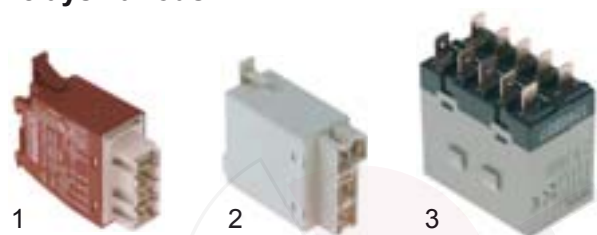

item	order no.	supply	contacts	switch power	faston (mm)	comparison-type
1	380332	24VDC	2NO	16A/250V	6,3	Schrack 0419 01 2901 00
1	380309	230VAC	2NO	16A/250V	6,3	Schrack 0419 01 0701 06 0419 01 1001 00
2	380318	230VAC	2NO	16A/250V	6,3	Schrack 0419 12 0301 00
3	380398	230VAC	3NO / 1NC	25A/250V	6,3	Omron G7J 3A1B T

## relay accessories

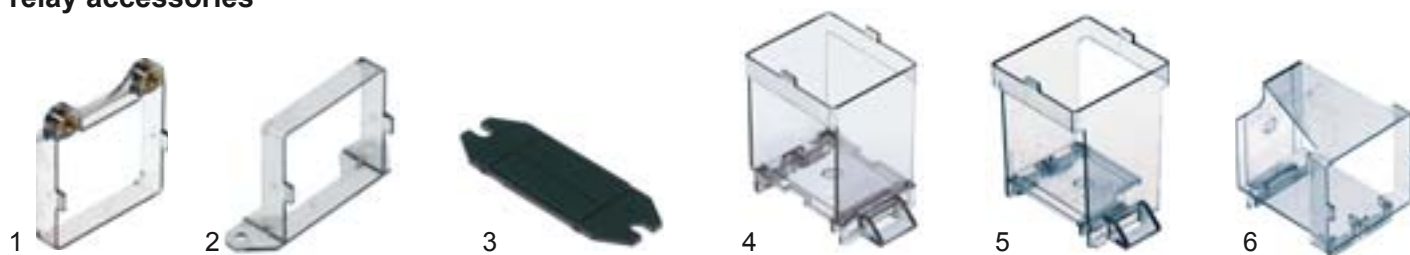

item	order no.	description	for relay type	comparison-type	item	order no.	description	for relay type	comparison-type
1	380703	adapter flange mounting	Finder 62.	062.10	4	380320	adapter DIN rail mounting	Finder 65.	065.07
2	380811	adapter strap fixing	Finder 62.	062.60	5	381003	adapter DIN rail mounting	Finder 62.	062.07
3	380321	adapter strap fixing	Universal	065.780	6	381039	adapter DIN rail mounting	Finder 62.	062.08

# Semiconductor relays

©GEV 2008

## semiconductor relays single phase



Celduc



Crouzet



Crydom

Pos	order no.	supply	output voltage	max. power	comparison-type Celduc	comparison-type Crouzet	comparison-type Crydom
1	401674	90–280VAC/DC	24–280VAC	10A	SO842974	84137001	
2	402062	4–32VDC	24–280VAC	25A	SO942460	84137010	
3	400781	3–32VDC	24–280VAC	50A	SO965406	84137020	D2450
4	402073	4–32VDC	48–660VAC	25A	SO965460	84137110	
5	401671	3–32VDC	48–530VAC	50A	SO965460		HD4850
6	402049	4–32VDC	48–660VAC	50A	SO965460	81437120	H12WD4850PG
7	402074	4–32VDC	48–660VAC	75A	SO967460	84137130	
8	402052	4–32VDC	48–660VAC	90A	SO868070		H12WD4890PG
9	401675	4–32VDC	48–660VAC	100A	SO868070		
10	402075	4–32VDC	48–660VAC	125A	SO869070	84134180	

## two phase



1



2



3



4



5

item	order no.	supply	output voltage	max. power	comparison-type Celduc	comparison-type Crydom
1	400559	24VDC	120/240VAC	2x40A	SCB564310	D2440DE-6816
2	401459	8–30VDC	24–600VAC	2x50A	SCB965600	-
3	401488	4–15VDC	48–530VAC	2x60A	-	H12D4840D
4	400105	4–15VDC	48–530VAC	2x60A	-	CY6152
5	401672	4–15VDC	48–530VAC	2x60A	SOB66530	-

## single phase DIN rail mounting



pos.	order no.	supply	output voltage	max. power	comparison-type
1	401462	5–30VDC	24–600VAC	4A	Celduc SKA 20460

## accessories semiconductor relay



1

item	order no.	description
1	401676	heat-conducting foil



2

item	order no.	description
2	890121	heat-conducting paste tube 100g

order no.: P020600801



Contactors, relay, semiconductor relay ©