

Lubricant distributors of product series 310



Version 03
951-170-235-EN



Masthead

Manufacturer

SKF Lubrication Systems Germany GmbH
Address of manufacturer plants

Headquarters

Walldorf Plant

Heinrich-Hertz-Str. 2-8
69190 Walldorf
Germany

Tel: +49 (0) 6227 33-0

Fax: +49 (0) 6227 33-259

Berlin Plant

Motzener Straße 35/37
12277 Berlin

Germany

Tel. +49 (0)30 72002-0

Fax +49 (0)30 72002-111

Hockenheim Plant

2. Industriestraße 4
68766 Hockenheim
Germany

Tel. +49 (0)62 05 27-0

Fax +49 (0)62 05 27-101

E-mail: Lubrication-germany@skf.com

www.skf.com/lubrication

Training

SKF conducts detailed training in order to enable the maximum safety and efficiency. SKF recommends taking advantage of this training. For information, contact the relevant SKF service address.

Copyright

© Copyright SKF

All rights reserved.

Warranty

The instructions do not contain any information on the warranty. This can be found in our General Terms and Conditions.

Disclaimer of liability

The manufacturer shall not be held liable for damage resulting from:

- Improper usage, assembly, operation, configuration, maintenance, repair, or accidents
- Improper reaction to malfunctions
- Unauthorized modifications to the product
- Intentional or gross negligence
- Use of non-original SKF spare parts















The maximum liability for loss or damage resulting from the use of our products is limited to the purchase price. Liability for indirect damage of any kind is excluded.

Table of contents

Masthead.....	3		
Explanation of symbols and signs	6		
1. Safety instructions.....	8	2. Lubricants.....	15
1.1 General safety instructions.....	8	2.1 General information	15
1.2 General behavior when handling the product.....	8	2.2 Selection of lubricants.....	15
1.3 Intended use.....	9	2.3 Material compatibility.....	16
1.4 Foreseeable misuse.....	9	2.4 Aging of lubricants.....	16
1.5 Painting plastic components	10	3. Overview, functional description	17
1.6 Modifications to the product.....	10	3.1 Components of product series 310.....	17
1.7 Prohibition of certain activities	10	3.2 General.....	18
1.8 Inspections prior to delivery.....	10	3.3 Operation of lubricant distributors of product series 310.....	18
1.9 Referenced documents.....	10	4. Technical data	20
1.10 Notes on the rating plate.....	11	4.1 General technical data.....	20
1.11 Note on Pressure Equipment Directive 2014/68/EU	11	4.2 Product code.....	21
1.12 Persons authorized to use the product.....	11	5. Delivery, returns, storage	22
1.12.1 Operator.....	11	5.1 Delivery	22
1.12.2 Qualified mechanic	12	5.2 Return shipment	22
1.12.3 Instruction of outside fitters.....	12	5.3 Storage.....	22
1.13 Provision of personal protective gear.....	12		
1.14 Operation.....	12		
1.15 Emergency shutdown	12		
1.16 Transport, assembly, maintenance, malfunction, repair, shutdown, disposal.....	12		
1.17 Initial commissioning, daily startup.....	14		
1.18 Cleaning	14		
1.19 Residual risks	14		

6.	Assembly	23	10.	Maintenance	35
6.1	General information	23	11.	Malfunctions, causes, and remedies	36
6.2	Assembly location	23	12.	Repairs	36
6.3	Mechanical connection.....	23	13.	Shutdown, disposal	37
6.3.1	Minimum mounting dimensions	23	13.1	Temporary shutdown	37
6.3.2	Assembly holes	23	13.2	Permanent shutdown, disassembly	37
6.4	Assembly of a 2-port lubricant distributor.....	24	13.3	Disposal.....	37
6.5	Assembly of a 3- or 5- port lubricant distributor.....	25	14.	Accessories	38
6.6	Connect the lubricant line.....	27	14.1	Plugs/clamp connections	38
6.6.1	Assembly process	28	14.2	Plastic tubing.....	38
6.7	Venting the lubricant distributors.....	31			
6.7.1	Venting procedure for main lubricant lines.....	31			
6.7.2	Venting procedure for lubricant distributor and lubrication point lines.....	32			
7.	Initial commissioning	33			
7.1	Inspections before initial commissioning.....	33			
7.2	Inspections during initial commissioning.....	33			
8.	Operation	34			
9.	Cleaning	34			
9.1	Cleaning agents.....	34			
9.2	Exterior cleaning	34			
9.3	Interior cleaning.....	34			

Explanation of symbols and signs

	General warning		Risk of slipping		Pressure injection		
	Wear personal protective gear (gloves)		Disposal, recycling		Unauthorized persons must be kept away.		Wear personal protective gear (protective clothing)
	Wear personal protective gear (goggles)		Wear personal protective gear (face mask)		General notes		Wear personal protective gear (protective footwear)
	Warning level	Consequence	Probability	Symbol	Meaning		
	DANGER	Death, serious injury	Immediate	●	Chronological instructions		
	WARNING	Serious injury	Possible	○	Bullet list items		
	CAUTION	Minor injury	Possible	➡	Indicates requirements for the action		
	IMPORTANT NOTE	Property damage	Possible	☞	Refers to other facts, causes, or consequences		

Abbreviations and conversion factors

re	regarding	°C	degrees Celsius	°F	degrees Fahrenheit
approx.	approximately	K	Kelvin	Oz.	ounce
i.e.	that is	N	Newton	fl. oz.	Fluid ounce
etc.	et cetera	h	hour	in.	inch
poss.	possibly	s	second	psi	pound per square inch
incl.	including	d	day	sq.in.	square inch
min.	minimum	Nm	Newton meter	cu. in.	cubic inch
max.	maximum	ml	milliliter	mph	miles per hour
min	minute	ml/d	milliliters per day	RPM	revolutions per minute
etc.	et cetera	ccm	cubic centimeter	gal.	Gallon
e.g.	for example	mm	millimeter	lb.	pound
kW	kilowatt	l	liter	hp	horsepower
U	voltage	db (A)	sound pressure level	kp	kilopound
R	Resistance	>	greater than	fpsec	feet per second
I	current intensity	<	less than	Conversion factors	
V	volt	±	plus minus	Length	1 mm = 0.03937 in.
W	watt	∅	diameter	Area	1 cm ² = 0.155 sq.in
AC	alternating current	kg	kilogram	Volume	1 ml = 0.0352 fl.oz.
DC	direct current	RH	relative humidity		1 l = 2.11416 pints (US)
A	ampere	≈	approximately	Mass	1 kg = 2.205 lbs
Ah	ampere hour	=	equal to		1 g = 0.03527 oz.
Hz	Frequency (Hertz)	%	percent	Density	1 kg/cm ³ = 8.3454 lb./gal(US)
NC	normally closed contact	‰	per mil (thousandth)		1 kg/cm ³ = 0.03613 lb./cu.in.
NO	normally open contact	≥	greater or equal	Force	1 N = 0.10197 kp
		≤	less or equal	Pressure	1 bar = 14.5 psi
		mm ²	square millimeter	Temperature	°C = (°F-32) x 5/9
		RPM	revolutions per minute	Power	1 kW = 1.34109 hp
				Acceleration	1 m/s ² = 3.28084 ft./s ²
				Speed	1 m/s = 3.28084 fpsec.
					1 m/s = 2.23694 mph

1. Safety instructions

1.1 General safety instructions

- The operator must ensure that the instructions are read by all persons tasked with working on the product or who supervise or instruct such persons. The operator must also ensure that the staff fully understands the content of the instructions. Putting the products into operation or operating them without having read the instructions is prohibited.
- Retain the instructions for further use.
- The products described here were manufactured according to the state of the art. Risks may, however, arise from non-compliant usage and may result in personal injury or damage to material assets.
- Any malfunctions which may affect safety must be remedied immediately. In addition to these instructions, the statutory regulations for accident prevention and environmental protection must be observed.

1.2 General behavior when handling the product

- The product may only be used in awareness of the potential dangers, in proper technical condition, and according to the information in this manual.
- Familiarize yourself with the functions and operation of the product. The specified assembly and operating steps and their sequences must be observed.
- Any unclear points regarding proper condition or correct assembly/operation must be clarified. Operation is prohibited until issues have been clarified.
- Unauthorized persons must be kept away.
- Wear personal protective equipment.
- All safety regulations and in-house instructions relevant to the particular activity must be observed.
- Responsibilities for different activities must be clearly defined and observed. Uncertainty seriously endangers safety.
- Protective and safety mechanisms must not be removed, modified, nor disabled during operation and must be checked for proper function and completeness at regular intervals.
- If protective and safety mechanisms must be removed, they must be reinstalled immediately following conclusion of work and then inspected for proper function.
- Any malfunctions that occur must be resolved according to responsibility. The supervisor must be notified immediately in case of malfunctions outside one's individual scope of responsibility.

1.3 Intended use

Feed lubricants only in compliance with the specifications, technical data, and limits presented in this manual.

The SKF lubricant distributor of product series 310 is designed for the metering of fluid greases up to NLGI grade 000-00 and oils of 20 – 1500 mm²/s in a single-line centralized lubrication system. The permissible operating pressure of the 310 distributor is between 12 and 38 bar. The relief pressure is 3 bar. The lubricant used must be suitable for elastomers (FKM (FPM)).

The technical requirements for the installation of the 310 lubricant distributor are set out in Chapter 6, "Assembly." These requirements must be complied with. The same applies to the technical specifications in Chapter 4.

Usage is permitted exclusively in the context of commercial or business activity by professional users.

1.4 Foreseeable misuse

Any usage of the product other than as specified in this manual is strictly prohibited. Particularly prohibited are:

- Use outside the specified pressure range
- Use outside the specified operating temperature range
- Use of non-specified equipment
- Use in areas with aggressive, corrosive substances (e.g., high ozone loads)
- in areas with damaging radiation (e.g., ionizing radiation)
- Use to feed, forward, or store hazardous substances and mixtures as defined in Annex I Part 2-5 of the CLP Regulation (EC 1272/2008) that are marked with hazard pictograms GHS01-GHS 09
- Use to feed / forward / store gases, liquefied gases, dissolved gases, vapors, or fluids whose vapor pressure exceeds normal atmospheric pressure (1013 mbar) by more than 0.5 bar at their maximum permissible operating temperature
- Use in an explosion protection zone

1.5 Painting plastic components

The painting of all plastic components and seals of the products described here is prohibited.

1.6 Modifications to the product

Unauthorized modifications and changes can have an unpredictable effect on safety. Unauthorized modifications and changes are therefore prohibited.

1.7 Prohibition of certain activities

The following activities must be performed only by employees of the manufacturer or authorized persons due to possibly undetectable sources of error or due to statutory requirements:

- Operation of the distributor in an incompletely assembled condition (e.g., missing lid)

1.8 Inspections prior to delivery

The following tests were performed prior to delivery:

- Safety and functional tests

1.9 Referenced documents

In addition to this manual, the following documents must be observed by the respective target group:

- Operational instructions, approval rules
- The safety data sheet of the lubricant used

If necessary:

- Project planning documents

- Instructions for other components for setting up the centralized lubrication system
- Other relevant documents for integration of the product into the main machine, system

1.10 Notes on the rating plate



The rating plate is firmly connected to the distributor body and the lid. Removing the lid results in destruction of the rating plate.

The rating plate provides important data such as the product code and serial number.

To avoid loss of this data in case the rating plate becomes illegible, these characteristics should be entered in the manual.

SKF Lubrication Systems Germany GmbH
DE 12277 Berlin

SKF

Product code

Lubricant distributor

Serial number

Product code:

Serial number:

1.11 Note on Pressure Equipment Directive 2014/68/EU

Due to its performance characteristics, the product does not reach the limit values defined in Article 4, Paragraph 1, Subparagraph (a) item (i) and is, pursuant to Article 4, Paragraph 3, excluded from the scope of Pressure Equipment Directive 2014/68/EU.

1.12 Persons authorized to use the product

1.12.1 Operator

A person competent due to training, knowledge, and experience to execute the functions and activities associated with normal operation; this also includes the avoidance of possible hazards that may arise during operation.

1.12.2 Qualified mechanic

A person with appropriate technical training, knowledge, and experience who can recognize and avoid the hazards that may occur during transport, assembly, commissioning, operation, maintenance, repair, and dismantling

1.12.3 Instruction of outside fitters

Before commencing work, the operator must inform outside fitters of the operational safety regulations, applicable accident prevention regulations, and the functions of the main machine and its protective devices.

1.13 Provision of personal protective gear

The operator must provide personal protective gear appropriate for the location and intended application.

1.14 Operation

The following must be observed during commissioning and operation:

- All information within this manual and all information within the referenced documents
- All laws and regulations that the operator must observe

1.15 Emergency shutdown

Shut down the product in an emergency by:

- Switching off the main machine in which the product is integrated
- If necessary, pressing the on/off switch on the main machine

1.16 Transport, assembly, maintenance, malfunction, repair, shutdown, disposal

- All relevant persons must be informed of the activity prior to the start of this work. Precautionary operational measures, work instructions must be observed.
- Maintenance and repair work can be subject to restrictions at low or high temperatures (e.g., altered flow properties of the lubricant). Maintenance and repair

- work should therefore preferably be performed at room temperature.
- Prior to performing work, the product and the machine in which the product will be integrated must be de-energized, depressurized, and secured against unauthorized activation.
 - Take appropriate measures to ensure that moving, detached parts are immobilized during the work and that no limbs can be pinched by unintended movements.
 - Assemble the product only outside the operating range of moving parts, at an adequate distance from sources of heat or cold. Other units of the machine, the vehicle must not be damaged or impaired in their function by the installation.
 - Dry any wet, slippery surfaces or cover appropriately.
 - Cover hot or cold surfaces appropriately.
 - Drill required holes only on non-critical, non-load-bearing parts. Use existing boreholes. Do not damage lines or cables when drilling.
 - Observe any possible wearing spots. Protect components appropriately.
 - All components used must be designed for:
 - The maximum operating pressure
 - The maximum/minimum ambient temperature
 - The lubricant to be delivered.
 - No parts may be subjected to torsion, shear, or bending.
 - Check parts for contamination before use and clean if necessary.
 - Lubricant lines should be filled with lubricant prior to assembly. This simplifies subsequent venting of the system.
 - Adhere to the specified torques. Use a calibrated torque wrench when tightening.
 - Avoid mixing up/incorrectly assembling disassembled parts. Label parts.

1.17 Initial commissioning, daily startup

Ensure that:

All connections are properly connected or bolted.

All parts are correctly installed.

1.18 Cleaning

- There is a fire hazard from the use of flammable cleaning agents. Use only non-flammable cleaning agents that are suitable for the intended purpose.
- Do not use corrosive cleaning agents.
- Do not use stream-jet equipment or high-pressure cleaners.

1.19 Residual risks

Residual risk	Possible in lifecycle	Avoidance / Remedy
Risk of slipping due to contamination by leaked lubricant	B, F, G, H, K	Promptly apply suitable binding agents and remove the leaked or spilled lubricant. Follow statutory and company regulations for the handling of lubricants.
Tearing/damage to lubricant lines and lubrication point lines when installed on moving machine components.	B, C, D	If possible, do not install on moving machine components. If it is necessary to do so, use flexible lubricant lines and lubrication point lines
Lubricant spraying out due to faulty fitting of threaded connections on lubricant lines	B, F, G	Tighten all threaded connections to the appropriate torques (where specified). Use threaded connections and lubricant lines suitable for the indicated operating pressures. Check all threaded connections and lubricant lines for correct connection and damage before putting into operation
Lifecycles: A = Transport, B = Assembly, C = Initial commissioning, D = Operation, E = Cleaning, F = Maintenance, G = Malfunction, repair, H = Shutdown, K = Disposal		

2. Lubricants

2.1 General information

Lubricants are used specially for specific applications. To fulfill the task, lubricants must meet various requirements to varying degrees. The most important requirements for lubricants are:

- Reduction in friction and wear
- Corrosion protection
- Noise reduction
- Protection against contamination/ingress of foreign matter
- Cooling (primarily for oils)
- Durability (physical/chemical stability)
- Compatible with as many materials as possible
- Economic and environmental aspects

2.2 Selection of lubricants

SKF Lubrication Systems considers lubricants to be an element of system design. The selection of a suitable lubricant should reasonably be made during the design of the machine and forms the basis for planning the centralized lubrication system.

The manufacturer/operator of the machine should preferably make the selection with the supplier of the lubricant on the basis of the requirements profile of the specific task.

If you have no or little experience selecting lubricants for centralized lubrication systems, please contact SKF.

We gladly assist our customers in the selection of suitable components for feeding the selected lubricant and in the planning and design of a centralized lubrication system.

This will spare you potentially costly downtime due to damage to the machine/system and/or damage to the centralized lubrication system.



Only lubricants specified for the product may be used (see “Technical data” chapter). Unsuitable lubricants may lead to failure of the product.



Do not mix lubricants. This can have unpredictable effects on the usability and this function of the centralized lubrication system.



Due to the large number of possible additives, it is possible that individual lubricants that meet the required specifications according to the manufacturer's data sheet are not suitable for use in centralized lubrication systems (e.g., incompatibility between synthetic lubricants and materials). To avoid this, always use lubricants that have been tested by SKF.

2.3 Material compatibility

The lubricants must generally be compatible with the following materials:

- Steel, brass, copper
- FKM (FPM). PA

2.4 Aging of lubricants

In case of extended machine downtime, check before re-commissioning that the lubricant is still suitable for use in terms of chemical and physical signs of aging. We recommend performing this inspection after one week of machine downtime.

In case of doubt regarding the suitability of the lubricant, replace it before re-commissioning and, if necessary, perform an initial lubrication manually.

It is possible for lubricants to be tested in the company's laboratory for their suitability for pumping in centralized lubrication systems (e.g., "bleeding").

Please contact SKF if you have further questions regarding lubricants.

An overview of the lubricants we have tested is available on request.

3. Overview, functional description

3.1 Components of product series 310

1	2-port distributor	
2	3-port distributor	
3	5-port distributor	
Metering pieces with clipped connection for lubrication point line		
4	Color of metering pieces	<u>cm³/stroke</u>
	Light blue	0.03
	Gray white	0.06
	Light gray	0.10
	Black	0.16
	Anthracite gray (dummy piece)	<u>0.00</u>
5	Lubrication point line clamping screw	
6	Distributor housing with lid	
7	Distributor clipped connection for main line connection on left	
8	Distributor clipped connection for main line connection on right	
9	Plug	
10	Main line clamping screws	

Overview of 310 distributor series, Fig. 1

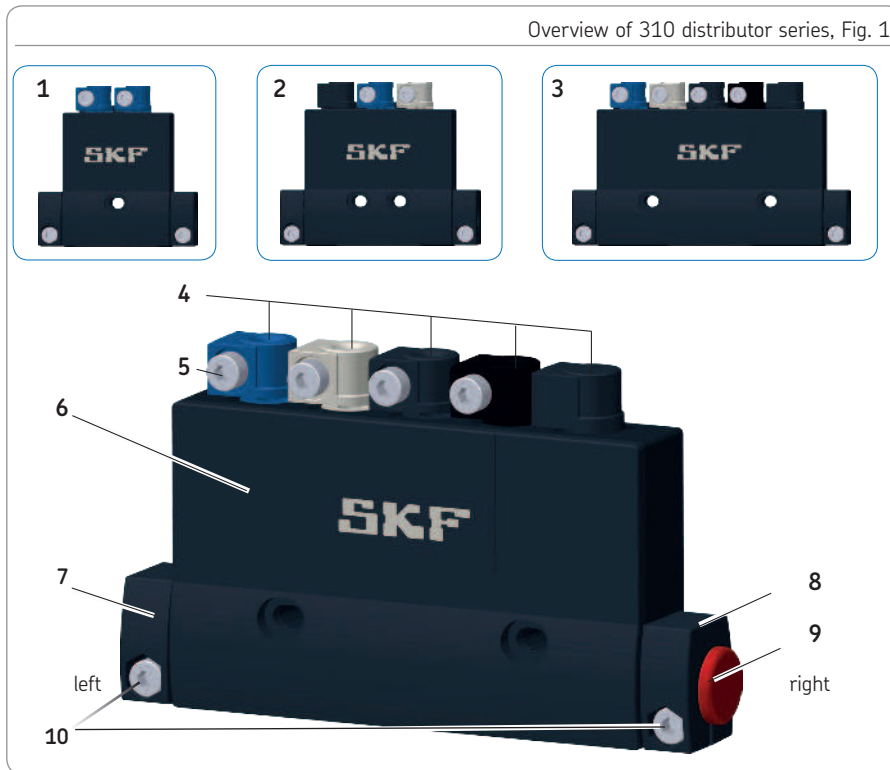

3.2 General

SKF lubricant distributors of product series 310 are available as two-, three- and five-port prelubrication distributors.

These are used in single-line centralized lubrication systems and feed fluid greases up to NLGI grade 000-00 and oils of 20 – 1500 mm²/s.

SKF lubricant distributors of product series 310 are intended primarily for use in machine tools and in automation.

SKF lubricant distributors of series 310 are made of plastic (exception: pressure springs, screws, nuts). The components made of elastomers inside the distributor are made of FKM (FPM). The lubricant distributors are therefore non-corroding.

They are available in a housing design with a maximum of two metering pieces and in housing designs with a maximum of three to five metering pieces. Unneeded lubricant outlets are closed with a blind plug.

The metering pieces are available with a non-adjustable delivery volume of 0.16; 0.10; 0.06, and 0.03 cm³ per stroke. The metering pieces are marked in different colors (see Overview, Chapter 3.1 and Product code, Chapter 4).

Visual monitoring of distributor function is not intended.

The lubrication point lines are connected to an SKF lubricant distributor of product series 310 by inserting the lubrication point line into the clipped connections of the metering pieces and securely tightening the associated clamping screws.

The main lubricant line is likewise connected to the main line connection using clipped connections; see Chapter 6.6.1.

3.3 Operation of lubricant distributors of product series 310

-See Figure 2

On SKF lubricant distributors of product series 310, the quantity of lubricant is fed to the lubrication point while pressure is being built up in the main lubricant line **(1)**, i.e., during the lubrication unit's run time.

To ensure that the lubricant distributor functions reliably, the pump pressure at the lubricant distributor must be between 12 and 38 bar.

After the lubrication unit is switched on, the lubricant is drawn out of the lubricant reservoir by the lubricant pump and fed to the lubricant distributor **(2)** through the main lubricant line **(1)**. The pressure built up in the centralized lubrication system opens the control sleeve **(3)** and the lubricant flows into the lower metering chamber **(4)**. The lubricant flowing into the lower metering chamber lifts the metering piston **(5)** with the lubricant **(6)** above it toward the outlet. The lubricant above the metering piston is pushed out of the upper metering

chamber (7) through the outlet (8), flowing through the secondary lubrication line to the lubrication point.

After the lubrication unit is turned off, pressure in the centralized lubrication system is relieved to below 3 bar, which relieves pressure in the main lubricant line. In this process, spring tension (9) causes the metering piston (5) to return to its normal position. At the same time, the lubricant is moved out of the lower metering chamber (4) and into the upper metering chamber (7). The SKF lubricant distributor of product series 310 is ready for the next lubrication cycle.

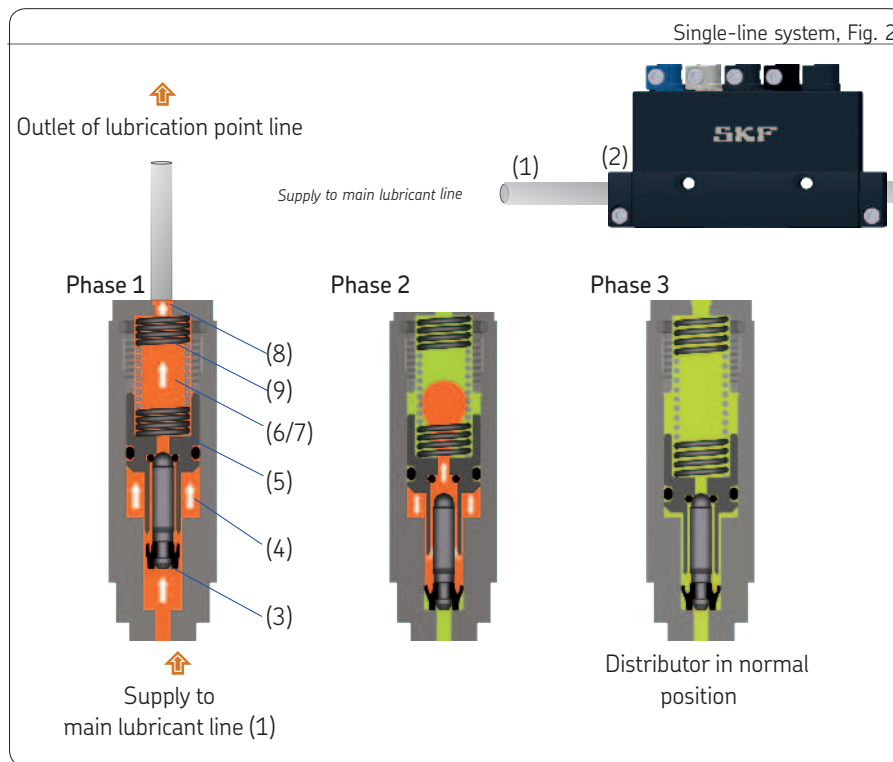

4. Technical data

4.1 General technical data

Designs	2-port; 3-port; 5-port		
Operating temperature range	5°C to 50°C		
Operating pressure	min. 12 bar to max. 38 bar		
Relief pressure	< 3 bar		
Material of lubricant line/lubrication point line	Preferably semi-rigid plastic tubing, optionally metal tubing without claw groove		
Line diameter	Lubrication point line Ø 4 mm, main line Ø 6 mm		
Actuation frequency	1 cycle per minute (depending on lubricant)		
Mounting position	Any, but not rotating		
Protection class according to DIN EN 60529 (VDE 0470-1)	IP 54		
Weight	2-port: Approx. 0.065 kg:	3-port: Approx. 0.085kg	5-port: Approx. 0.12kg
Metered quantity	Non-adjustable metering pieces with a metered quantity of: Dummy piece	0.16 cm ³ /stroke 0.10 cm ³ /stroke 0.06 cm ³ /stroke 0.03 cm ³ /stroke 0.00 cm ³ /stroke	
Feedable lubricants	Fluid greases of NLGI grade 000-00 Oils with an operating viscosity of 20 – 1500 mm ² /s		
Purity level of permissible oils	ISO 4066:1999 NAS 1638	<= class 19/17/14 <= class 8, recommended degree of filtration 5 to 10 µm	

4.2 Product code

31 X - 8 0 0 -

Product series 310	
Number of metering points	
2	2 metering points
3	3 metering points
5	5 metering points
Design key	
Elastomer material	∅ lubrication point line [mm]
800	4
Metered quantity	
Metered quantity [cm ³ /stroke]	Color coding
0	Not present
2	0.03
3	0.06
4	0.10
5	0.16
Y	blind plug

* Not available for 2-port distributor 312 =0
 ** Not available for 2- or 3-port distributor 313 =0 / 315 =0

∅ main line [mm]	
B	6
Y	closed with plugs

Metering point 1
 Metering point 2
 Metering point 3 *
 Metering point 4 **
 Metering point 5 **
 Main line connection on left
 Main line connection on right

Order example:

- Product code for an SKF lubricant distributor of product series 310 (31)
- with 5 metering points (5)
 - in FKM (FPM) design, with 4 mm lubrication point connection (800)
 - Metering for metering point 1 of 0.03 cm³/stroke (2),
 - Metering point 2 of 0.06 cm³/stroke (3),
 - Metering point 3 of 0.10 cm³/stroke (4),
 - Metering point 4 of 0.16 cm³/stroke (5),
 - Metering point 5 of 0.00cm³/stroke (closed, Y),
 - with 6 mm main line connection on left (B)
 - with 6 mm main line on right (B) is:

315-800-2345Y-BB**Note!**

The product code for the distributors is shown on the rating plate attached to the bottom.

5. Delivery, returns, storage

5.1 Delivery

After receipt of the shipment, it must be inspected for any shipping damage and for completeness according to the shipping documents. Immediately inform the transport carrier of any shipping damage.

The packaging material must be preserved until any discrepancies are resolved. Safe handling must be ensured during on-site transport.

The product must be protected from mechanical effects such as impacts. There are no restrictions for land, air, or sea transport.

The following must be marked on the packaging of return shipments:



- Protected from nearby sources of heat or cold
- In case of large temperature fluctuations or high humidity, take appropriate measures (e.g., heating) to prevent the formation of condensation water.
- The permissible storage temperature range corresponds to the operating temperature range (see “Technical data”).

5.2 Return shipment

A lubricant distributor should, if possible, be returned in the original product packaging. Before return shipment, all contaminated parts must be cleaned and properly packed (i.e., according to the requirements of the recipient country).

5.3 Storage

The following conditions apply to storage:

- Dry, low-dust, vibration-free, in closed rooms
- No corrosive, aggressive substances at the storage location (e.g., UV rays, ozone)



Before usage, check products for damage that may have occurred during storage. This applies in particular to parts made of plastic and rubber (due to embrittlements) as well as components prefilled with lubricant (due to aging).

6. Assembly

6.1 General information

Only qualified technical personnel may install the products specified in the instructions.

During assembly, pay attention to the following:

- Other units must not be damaged by assembly work.
- The product must not be installed within range of moving parts.
- The product must be installed at a sufficiently large distance from sources of heat or cold.
- Contact with machining chips must be ruled out due to the housing material used.

- Observe the IP protection class of the product
- Maintain safety clearances and comply with statutory regulations for assembly and accident prevention.
- Follow the mounting position requirements in “Technical data” (Chapter 4).

6.2 Assembly location

The product should, to the extent possible, be protected from humidity and vibration, and should be mounted so that it is easily accessible. This facilitates further installation, inspection, and maintenance work on the product.

6.3 Mechanical connection

6.3.1 Minimum mounting dimensions

To ensure enough space for maintenance work or clearance for possible disassembly of the product, ensure that the minimum mounting dimensions specified in the assembly drawings are maintained.

6.3.2 Assembly holes

The product is secured using one (two-port distributor) or two (three- and five-port distributors) assembly holes.

Recommended fastening hardware

- Hexagon socket screw acc. to EN ISO 4762, M4-8.8
- Washer acc. to ISO7092, nominal size 4

6.4 Assembly of a 2-port lubricant distributor

-See Chapter 3, Figure 1

-See Figure 3

- Check the parallelism of the surface on which the component is to be installed. Stress-free installation of the distributor must be ensured.
- Check for any fouling on the threaded hole (M4) for distributor installation and on the surface on which the component is to be installed, and clean if needed.
- Place the lubricant distributor on the mounting surface and fasten it finger-tight using a hexagon socket screw and washer.
- Align the lubricant distributor
- Tighten the hexagon socket screw with a torque of 1 Nm (+20%)

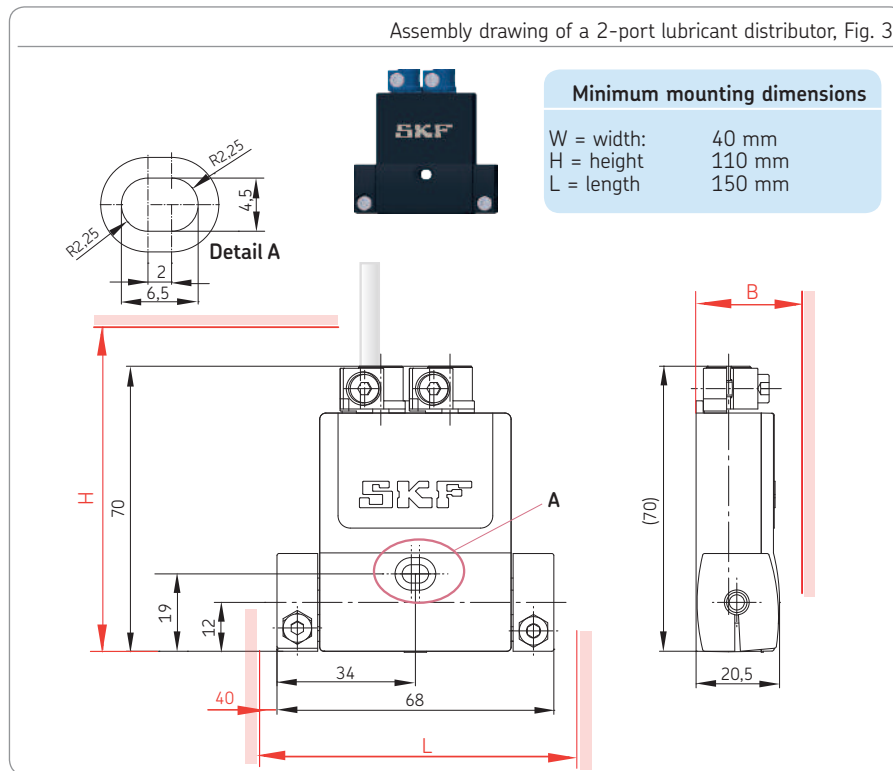

6.5 Assembly of a 3-or 5-port lubricant distributor

-See Chapter 3, Figure 1

-See Figure 4 and Fig. 5

- Check the parallelism of the surface on which the component is to be installed. Stress-free installation of the distributor must be ensured.
- Check for any fouling on the threaded holes (M4) for distributor installation and on the surface on which the component is to be installed, and clean if needed.
- Place the lubricant distributor on the mounting surface and fasten it finger-tight using two hexagon socket screws and two washers.
- Align the lubricant distributor
- Tighten the hexagon socket screws with a torque of 1 Nm (+20%)

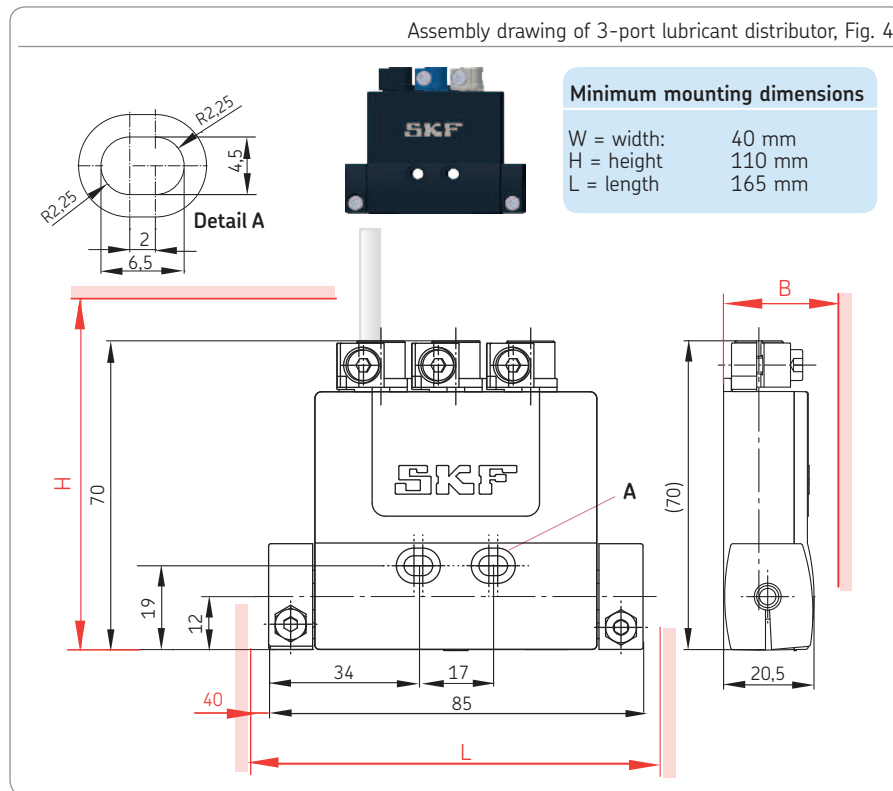

Assembly drawing of 5-port lubricant distributor, Fig. 5

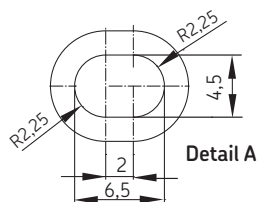

**Minimum mounting dimensions**

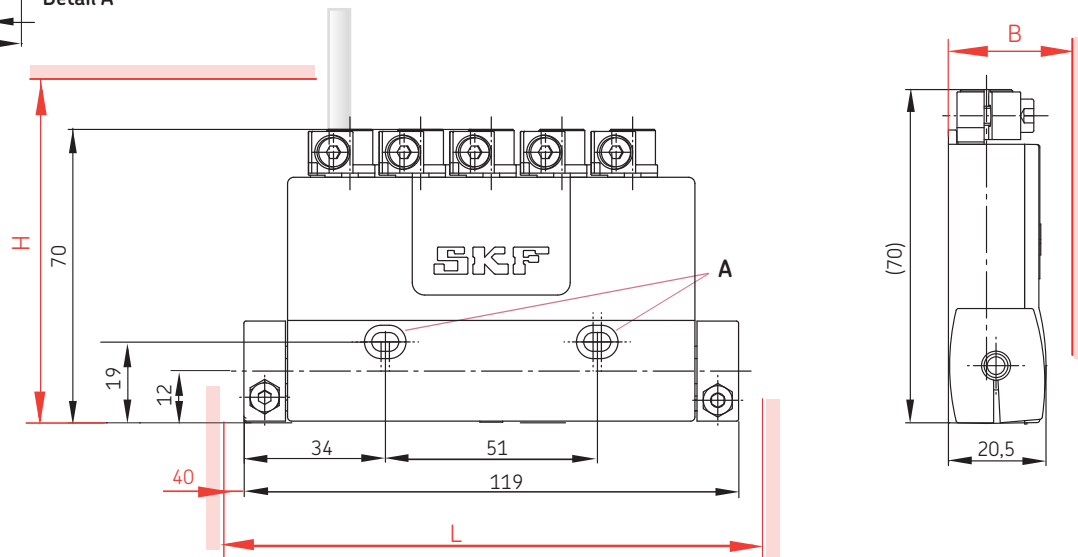
W = width:	40 mm
H = height:	110 mm
L = length:	200 mm



6.6 Connect the lubricant line

-See Figure 6

 CAUTION
 <p>Risk of slipping Exercise caution when handling lubricants; immediately bind and remove any leaked lubricants.</p>



Connect the lubricant lines in such a way that no forces are transferred to the product (stress-free connection).



Secure the centralized lubrication system against excessive pressure using an appropriate pressure regulating valve.

All components of the centralized lubrication system must be designed for:

- The maximum pressure that occurs
- The permissible temperature range
- The delivery rate and the lubricant to be fed

Observe the following installation instructions for safe and trouble-free operation.

- Use only clean components and prefilled lubricant lines.
- The main lubricant line should be arranged ascending and be ventable at the highest point. Lubricant lines should always be arranged so that air pockets cannot form anywhere.
- Install lubricant distributor at the end of the main lubricant line such that the outlets of the lubricant distributor point upwards.
- If the system configuration requires that the lubricant distributors be arranged below the main lubricant line, they should not be placed at the end of the main lubricant line.
- The flow of lubricant should not be impeded by the incorporation of sharp

bends, angle valves, flap valves, seals protruding inward, or changes in cross-section. Unavoidable changes in the cross-section in the lubricant lines must have smooth transitions.

6.6.1 Assembly process

-See Figure 6

Semi-rigid plastic tubing according to the SKF specification (WVN715) with a tubing diameter of 6 mm should be used for installation of the main lubricant lines on the lubricant metering devices.

In compliance with the technical operating conditions according to SKF brochure "Fittings and Accessories," brochure No. 1-0103-EN, soft plastic tubing according to the SKF specification (WVN716) with a tubing diameter of 6 mm can also be used in the individual case to be inspected.

Semi-rigid or soft plastic tubing (WVN 715/-716) with a tubing diameter of 4 mm can be used for installation of the lubricant lines. The use of plastic tubing that does not comply with the SKF specification may cause functional impairments.

If steel tubing is used, **no claw grooves** may be present.

Connecting the main lubricant lines

- Use tubing scissors **(1)** to cut the main lubricant lines **(2)** to the required lengths, ensure there are no burrs
- Loosen the hexagon socket screw **(3)** (WAF 3) of the clipped connection **(4)** on the main line connection on the left
- Insert the main lubricant lines **(2)** into the clipped connection **(4)** to the stop position (approx. 23 mm), overcoming the resistance of the inserted O-ring **(5)**
- Bring the main lubricant lines into mounting position
- Tighten the hexagon socket screw **(3)** until the clamp gap **(6)** on the clipped connection **(4)** is closed (this is the case at approx. 1.5 Nm)
- If necessary, repeat the assembly procedure on the main line connection on the right

Connecting the lubrication point lines

- Use tubing scissors **(1)** to cut the lubrication point lines **(7)** to the required lengths, ensure there are no burrs
- Loosen the hexagon socket screw **(8)** (WAF 3) of the clipped connection **(9)** on the metering piece **(10)**.
- Insert lubrication point lines **(7)** into the clipped connection to the stop position **(9)** (approx. 29.5 mm) overcoming the resistance of the inserted O-ring **(11)**
- Bring the lubrication point lines into mounting position
- Tighten the hexagon socket screw **(8)** until the clamp gap **(12)** on the clipped connection **(9)** is closed (this is the case at approx. 1.5 Nm)
- Repeat the assembly procedure on the other metering pieces

Assembly of main lubricant lines and lubrication point lines, Fig. 6

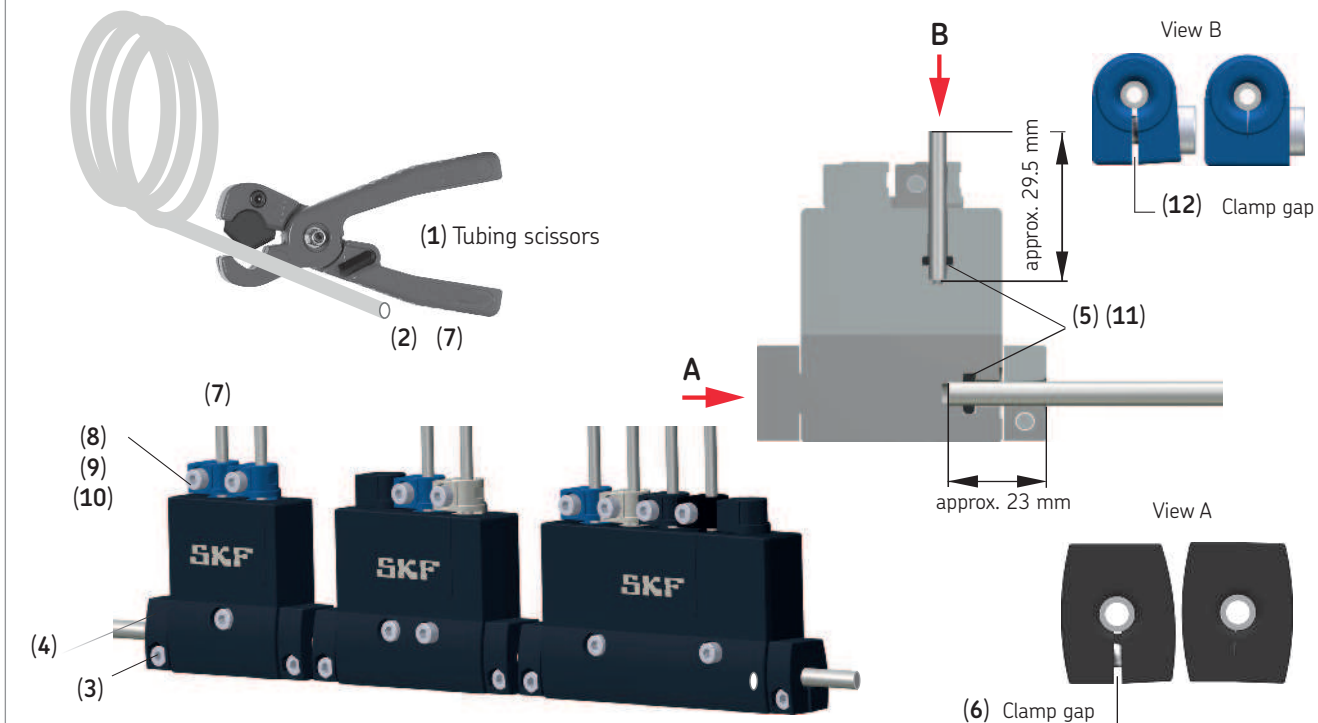

6.7 Venting the lubricant distributors

-See Figure 7 and Fig. 8

Requirement

- Lubricant pump and components of the single-line centralized lubrication system have been mounted correctly
- Lubricant pump is already filled with lubricant and subsequently vented
- Main lubricant lines and lubrication point lines are already filled with lubricant

6.7.1 Venting procedure for main lubricant lines

See Figures 7 and 8

The venting procedure for the main lubricant lines is carried out on the main lubricant lines on the lubricant distributor (1) farthest from the lubrication pump

- Switch on the lubricant pump (2)
- Loosen the hexagon socket screw of the clipped connection (4) on the distributor outlet (3) (WAF 3)
- Remove the plug (5)
- Allow the lubricant pump (2) to run until bubble-free lubricant discharges at the clipped connection (4).
- Insert the plug (5) into the clipped connection (4) to the stop position, overcoming the resistance of the inserted O-ring
- Tighten the hexagon socket screw (4) until the clamp gap on the clipped connection is closed (this is the case at approx. 1.5 Nm)



Repeat if necessary in case of branches.

Single-line system with lubricant distributors of product series 310, Fig. 7

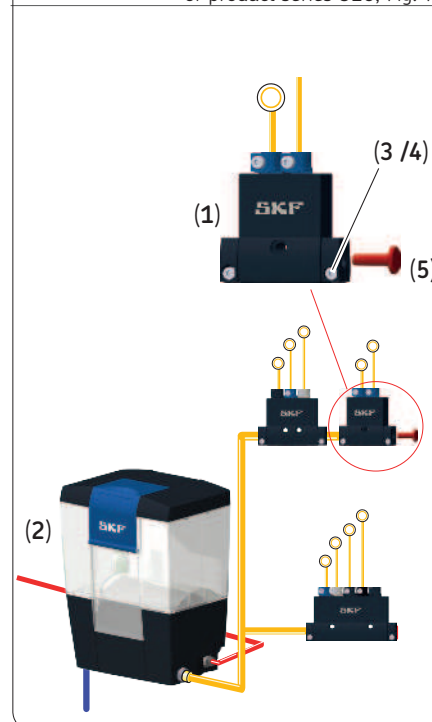

6.7.2 Venting procedure for lubricant distributor and lubrication point lines

See Figure 8

If air is still present in the distributor or in the lubrication point lines after venting the main lines, the distributor/lubrication point lines must be vented as well.

Proceed as follows:

Start venting from the closest connected lubricant distributor.

- Switch off the lubricant pump
- Loosen the hexagon socket screw (1) (WAF 3) on the clipped connections (2)
- Remove the lubrication point lines (3) from the O-ring (4)
- Switch on the lubricant pump and allow to run until bubble-free lubricant discharges at all clipped connections of the lubrication point lines.

- Insert the lubrication point lines (3) into the clipped connections to the stop position (4), overcoming the resistance of the inserted O-ring
- Tighten the hexagon socket screw (1) until the clamp gap on the clipped connection is closed (this is the case at approx. 1.5 Nm)
- Loosen the lubrication point lines (3) at the lubrication points
- Switch on the lubricant pump
- Once bubble-free lubricant discharges at the tube ends, retighten the lubrication point lines
- Switch off the lubricant pump
- If necessary, repeat the venting procedure on the subsequent lubricant distributors

- Clean the exterior of lubricant distributors and connections

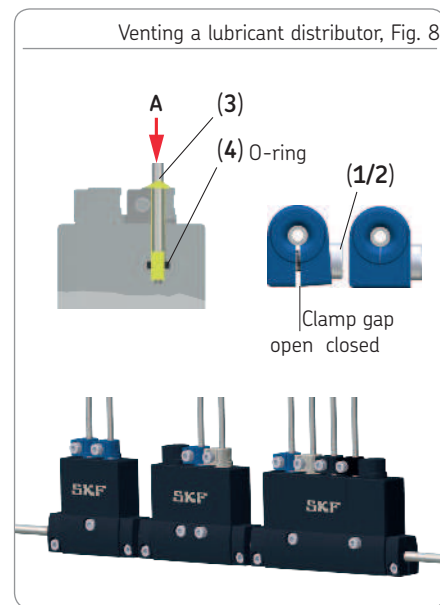

7. Initial commissioning

To ensure safety and functionality, the person specified by the operator is required to perform the following inspections. Any detected deficiencies must be resolved immediately. The correction of deficiencies must be done exclusively by a specialist competent and authorized to do so.

Checklist for commissioning

7.1 Inspections before initial commissioning

YES NO

Mechanical connection established correctly	<input type="checkbox"/>	<input type="checkbox"/>
The performance data for the aforementioned connections matches the specifications in "Technical data"	<input type="checkbox"/>	<input type="checkbox"/>
All components such as lubrication point lines are correctly mounted	<input type="checkbox"/>	<input type="checkbox"/>
No apparent damage or contamination	<input type="checkbox"/>	<input type="checkbox"/>
Any dismantled protective and monitoring equipment is fully reinstalled and functional	<input type="checkbox"/>	<input type="checkbox"/>

7.2 Inspections during initial commissioning

No undesired discharge of lubricant at connections (leaks)	<input type="checkbox"/>	<input type="checkbox"/>
Lubricant is fed without bubbles	<input type="checkbox"/>	<input type="checkbox"/>
The bearings and friction points requiring lubrication receive the planned amount of lubricant	<input type="checkbox"/>	<input type="checkbox"/>

6

7

8. Operation

SKF products operate automatically.

The activities required during normal operation are limited primarily to cleaning of the exterior of the product if contaminated.

NOTE!

The lubricant metering device of product series 310 is made almost entirely of functional high-performance plastics, some of whose semi-crystalline basic structure causes them to react to water-based media.



To always ensure that the lubricant metering device functions properly, it is recommended that you avoid constant and excessive contact with water-based media (e.g., cooling lubricant). Further, contact with acids or oxidizing chemicals must be excluded.

9. Cleaning

During cleaning, pay attention to the following:

Cleaning, required personal protective gear, cleaning agents, and equipment are in accordance with the current operating rules of the operator.

9.1 Cleaning agents

Only cleaning agents compatible with the materials can be used for cleaning (see Chapter 2.3 for materials).



Always completely remove residue of the cleaning agent on the product and rinse with clear water. This prevents the formation of alkaline deposits.

9.2 Exterior cleaning

- Mark and secure wet areas.
- Unauthorized persons must be kept away.
- Thoroughly clean all external surfaces with a moist cloth.

9.3 Interior cleaning

Cleaning of the interior of the distributor/metering pieces is prohibited.

10. Maintenance

Careful and regular maintenance is required in order to detect and remedy possibly malfunctions in time. The specific intervals must always be determined by the operator according to the operating conditions and regularly reviewed and adapted where necessary. If necessary, copy the table for regular maintenance activities.

Maintenance checklist		
Activity to be performed	YES	NO
Mechanical connection established correctly	<input type="checkbox"/>	<input type="checkbox"/>
All components such as lubricant lines and lubricant distributors are correctly mounted	<input type="checkbox"/>	<input type="checkbox"/>
No apparent damage or contamination	<input type="checkbox"/>	<input type="checkbox"/>
Any dismantled protective and monitoring equipment is fully reinstalled and functional	<input type="checkbox"/>	<input type="checkbox"/>
No undesired discharge of lubricant at connections	<input type="checkbox"/>	<input type="checkbox"/>
Lubricant is fed without bubbles	<input type="checkbox"/>	<input type="checkbox"/>
The bearings and friction points requiring lubrication receive the planned amount of lubricant	<input type="checkbox"/>	<input type="checkbox"/>

8

9

10

11. Malfunctions, causes, and remedies

12. Repairs

Malfunctions table

Malfunction: <i>No lubricant at the lubrication point</i>	
Possible cause	Remedy
Insufficient system pressure at main line connection	Check system pressure at the main line connection, increase system pressure if necessary (min. 12 bar to max. 38 bar)
Distributor jam/ insufficient pressure relief	Trigger interim lubrication while loosening the clipped connection on the lubrication point line of the affected metering piece. The distributor is working correctly if lubricant can be clearly seen discharging.
Contamination hardened grease	Distributor jam: - Switch off lubricant pump, relieve pressure, replace distributor
	Lubrication point lines: - Check lubrication point lines for clogging, pinching, kinking, hardened grease, or clogging of the lubrication point; remedy the cause..
	Main lubricant lines: - Flush the main line; to do so, remove the plug on the last lubricant distributor switch on the pump, and replace the plug only once dirt-free lubricant discharges consistently.

The 310 series lubricant distributor is not designed to be repaired.



NOTE!

The main lines and lubrication lines are each secured to the lubricant metering device of product series 310 using a clipped connection. If the main line and/or the lubricant lines are to be replaced, SKF recommends also replacing the affected lubricant metering device at the same time.

If replacement is not performed, the metering device's function may be impaired under certain circumstances.

13. Shutdown, disposal

13.1 Temporary shutdown

Temporary shutdown is performed by:

Switching off the main machine

13.2 Permanent shutdown, disassembly

Permanent shutdown and disassembly of the product must be planned properly by the operator and conducted in compliance with all applicable requirements.

13.3 Disposal

Waste should be avoided or minimized to the extent possible. The disposal of products contaminated with lubricant must be performed by a recognized waste disposal company in compliance with environmental protection requirements and waste disposal regulations as well as the requirements of local authorities.



The producer of waste is responsible for its specific classification, as the European Waste Catalog provides for different disposal keys for waste that is the same but of different origin.

Plastic or metallic parts that have been cleaned of lubricant can be disposed of as industrial waste.



11

12

13

14. Accessories

14.1 Plugs/clamp connections

Item	Designation	Units	Item number
1	Plug	1	898-210-001
2	M4 clamping screw	1	DIN 912-M4x10-8.8
3	Nut for M4 clamping screw	1	DIN 934-M4-5

14.2 Plastic tubing

Designation	Tube Ø	Units	Item number
Plastic tubing (unplasticized)	4 mm	1)	WVN715-R04x0.85
	6 mm		WVN715-R06x1
			WVN715-R06x1.25
			WVN715-R06x1.5
Plastic tubing, flexible (plasticized)	4 mm	2)	WVN716-R04x0.85
	6 mm		WVN716-R06x1.25

Special scissors for plastic tubing (tubing scissors)	226-12508-5
---	-------------

Note!



You can find additional technical data in the brochures:	Brochure No.:
Lubricant Distributors for SKF MonoFlex Systems	1-5001-EN
Fittings and Accessories	1-0103-EN
Transport of Lubricants in Centralized Lubrication Systems	1-9201-EN

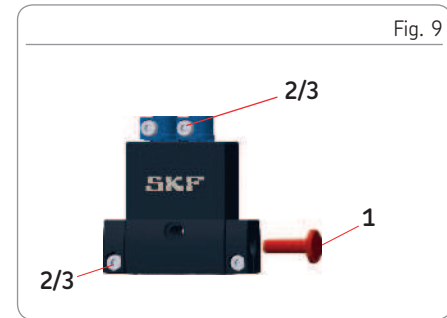

Fig. 9

1) Add the desired length, e.g. 30 meters, to the order number.

Order example:

WVN715-R04x0.85 x30 meters

2) When using flexible plastic tubing, observe its technical operating conditions according to SKF brochure "Fittings and accessories," brochure No. 1-0103-EN.

Notes

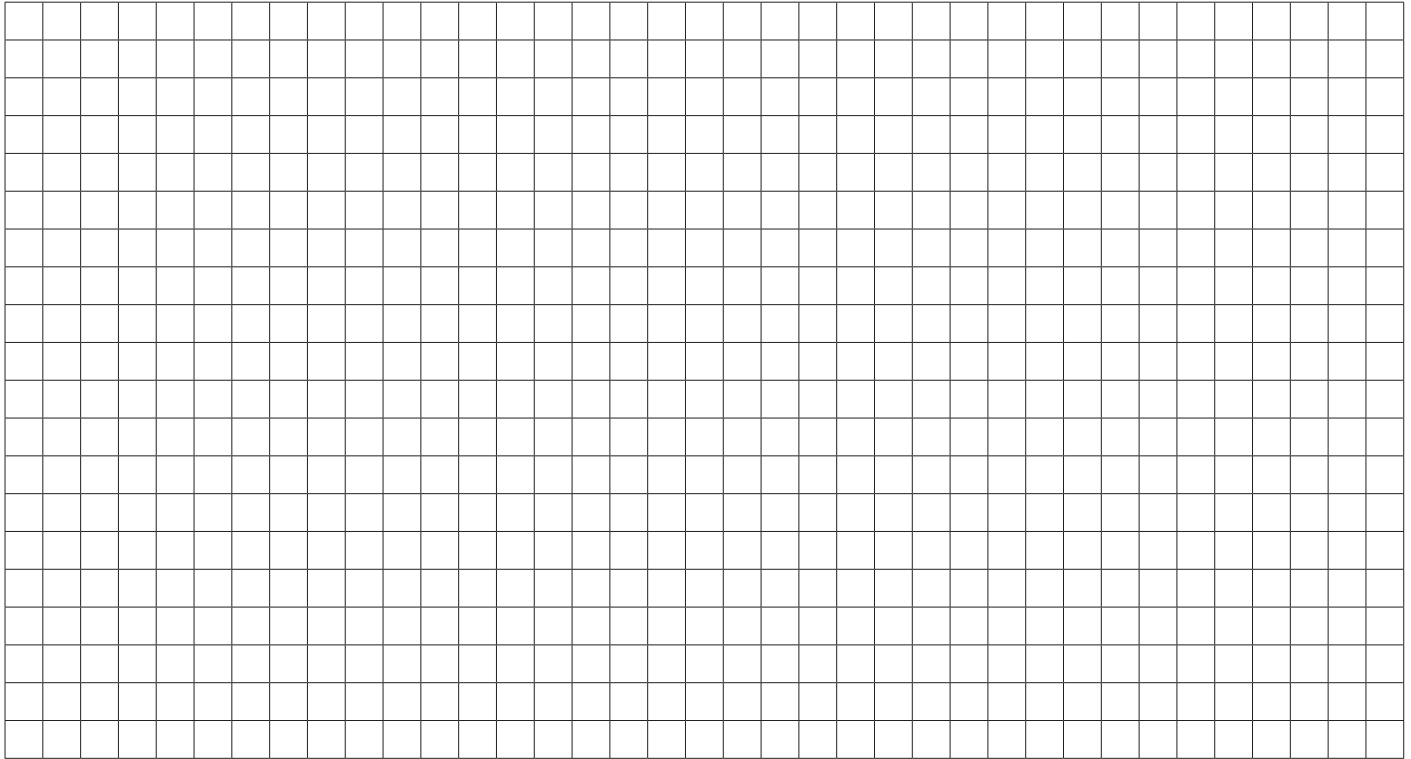

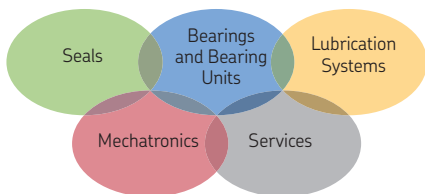

The Power of Knowledge Engineering

Over the course of more than a century, SKF has specialized in five fields of competence and acquired a wide range of application expertise. We utilize this experience to provide innovative solutions to OEMs and other manufacturers in practically all industrial sectors worldwide.

Our five fields of competence are: Bearings and bearing units, seals, mechatronics (combining mechanical and electronic components to improve the performance of classic systems), and extensive services from 3-D computer stimulations and modern condition monitoring systems for high reliability to system management. SKF is a leading global company and guarantees its customers uniform quality standards and global product availability.

951-170-235-EN

June 2018

Version 03

SKF Lubrication Systems Germany GmbH

Motzener Straße 35/37 · 12277 Berlin · Germany

PO Box 970444 · 12704 Berlin · Germany

Tel. +49 (0)30 72002-0

Fax +49 (0)30 72002-111

www.skf.com/lubrication

