

COMBIVERT



GB Instruction manual
Standard and Interface Operator

COMBIVERT F5

Translation of Original Manual		
Document	Part	Version
20104044	GBR	00

KEB

Table of Contents

1.	Preface.....	5
1.1	General	5
1.2	Validity and liability	5
1.3	Copyright.....	6
1.4	Specified application.....	6
1.5	Product description.....	6
2.	Connection and Operation	7
2.1	Operation without operator	7
2.2	Operation with digital operator	7
2.2.1	Keyboard operation	7
2.2.1.1	Parameter numbers and values.....	7
2.2.1.2	Resetting of error messages.....	8
2.2.1.3	password input.....	8
2.3	Interface operator (part number 00F5060-2000)	9
2.3.1	Description of the diagnostic and parameter interface X6B.....	9
2.3.2	Description of the RS232/485 interface X6C	10
2.3.3	Remote control	10
2.3.4	Other operators.....	10
3.	Customer Parameters (CP-Mode)	11
3.1	General	11
3.2	Operating modes	11
3.3	Factory setting for operating mode „GENERAL“	12
3.3.1	Password input	13
3.3.2	Operating Display	14
3.3.3	Basic adjustment of the drive.....	16
3.3.4	Special Adjustments	19
3.4	Factory setting for operating mode „MULTI“	33
3.4.1	Password input	34
3.4.2	Operating Display	35
3.4.3	Basic adjustment of the drive.....	37
3.4.4	Special Adjustments	39
3.4.5	Factory Settings.....	47
3.4.6	Initial Start-up.....	49
3.4.7	Adjustment speed controller	51
3.5	Factory setting for operating mode „SERVO“	52
3.5.1	Password input	53
3.5.2	Operating Display	54
4.	Drive Mode	68
4.1	Start/stop drive	68
4.2	Change Direction of rotation	68
4.3	Presetting the set value	68
4.4	Leave drive mode	68

Table of Contents



5.	Error Assistance	69
6.	Quick Guide	76
6.1	Quick guide for operating mode „GENERAL“	76
6.2	Quick guide for operating mode „MULTI“	78
6.3	Factory setting for operating mode „SERVO“	79
7.	Passwords.....	80

1. Preface

1.1 General

The described hard- and software are developments of the Karl E. Brinkmann GmbH. The enclosed documents correspond to conditions valid at printing. Misprint, mistakes and technical changes reserved.

The instruction manual must be made available to the user. Prior to performing any work on the unit the user must familiarize himself with the unit. This especially applies to the knowledge and observance of the following safety and warning indications. The used pictograms have following significance:

 <p>Danger Warning Caution</p>	<p>Is used, if life or health of the user are endangered or substantial damage to property can occur.</p>
 <p>Attention observe at all costs</p>	<p>Is used, if a measure is necessary for safe and trouble-free operation.</p>
 <p>Information Aid Tip</p>	<p>Is used, if a measure simplifies the handling or operation of the unit.</p>

Non-observance of the safety instructions leads to the loss of any liability claims. This list is not exhaustive.

1.2 Validity and liability

The use of our units in the target products is outside of our control and therefore lies exclusively in the area of responsibility of the machine manufacturer.

The information contained in the technical documentation, as well as any user-specific advice in spoken and written and through tests, are made to best of our knowledge and information about the application. However, they are considered for information only without responsibility. This also applies to any violation of industrial property rights of a third-party.

Selection of our units in view of their suitability for the intended use must be done generally by the user.

Tests can only be done within the application by the machine manufacturer. They must be repeated, even if only parts of hardware, software or the unit adjustment are modified.

Unauthorised opening and tampering may lead to bodily injury and property damage and may entail the loss of warranty rights. Original spare parts and authorized accessories by the manufacturer serve as security. The use of other parts excludes liability for the consequences arising out of.

The suspension of liability is especially valid also for operation interruption loss, loss of profit, data loss or other damages. This is also valid, if we referred first to the possibility of such damages.

If single regulations should be or become void, invalid or impracticable, the effectivity of all other regulations or agreements is not affected.

1.3 Copyright

The customer may use the instruction manual as well as further documents or parts from it for internal purposes. Copyrights are with KEB and remain valid in its entirety.

1.4 Specified application

The operator is used exclusively for the operation, remote control or networking of a COMBIVERT F5. The used semiconductors and components of KEB are developed and dimensioned for the use in industrial products. If the KEB COMBIVERT F5 is used in machines, which work under exceptional conditions or if essential functions, life-supporting measures or an extraordinary safety step must be fulfilled, the necessary reliability and security must be ensured by the machine builder. The operation of our products outside the indicated limit values of the technical data leads to the loss of any liability claims.

1.5 Product description

The following operators are described in this manual:

Material number	Operator	Bus type
00F5060-1100	Digital operator	–
00F5060-2000	Interface operator	RS232/485HSP5

The digital operator is used for local operation of the COMBIVERT. The operator has a 5-digit digital display and a status LED. The input occurs via touch pad keyboard. The interface operator also includes a serial interface RS232/485 and a HSP5 diagnostic interface.



This accompanying instruction manual contains information for the installation and connection of the control of the KEB COMBIVERT F5, as well as the safety technology.
This manual is only valid in connection with the power- and control circuit manual. These include the general safety requirements and instructions for EMC conform installation.

2. Connection and Operation

2.1 Operation without operator

A special HSP5 cable (Part No. 00F50C0-0010) is available for the operation of the KEB COMBIVERT without operator. The cable is connected between HSP5 interface X4A and serial RS232 PC interface (COM1 or COM2). Operation occurs via the program COMBIVIS.

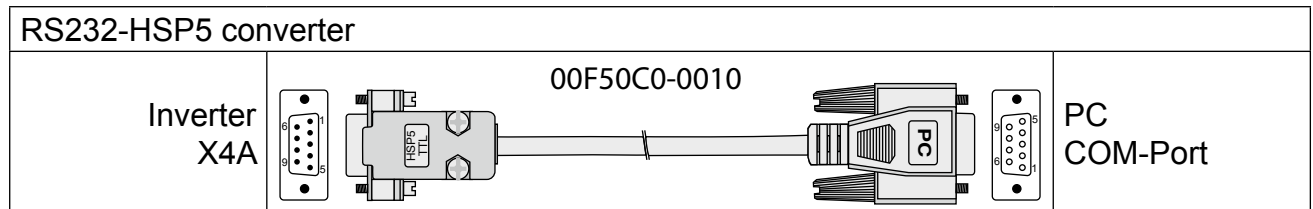

The RS232-HSP5 service cable has an integrated level converter. The connection of a serial standard cable would destroy the PC interface.

2.2 Operation with digital operator

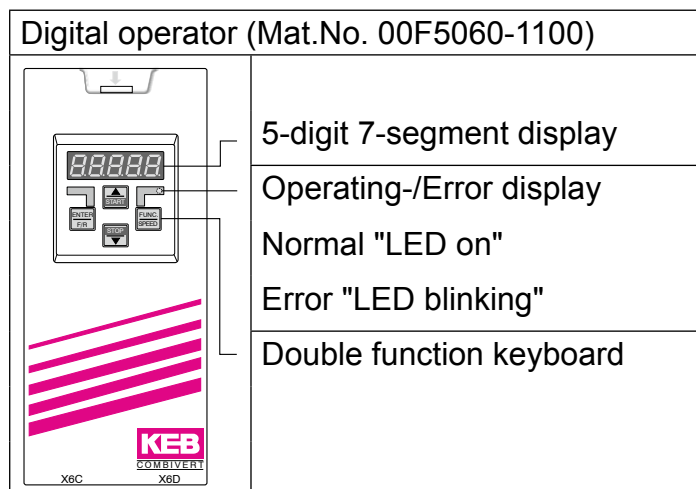

A digital operator is available as accessory for the local operation of the KEB COMBIVERT. To prevent malfunctions, the inverter must be brought into nOP status before connecting / disconnecting the operator (open control release terminal). When starting the inverter, it is started always with the last stored values or factory setting.

2.2.1 Keyboard operation

2.2.1.1 Parameter numbers and values

When switching on KEB COMBIVERT F5 the value of customer parameter CP.01 is displayed.

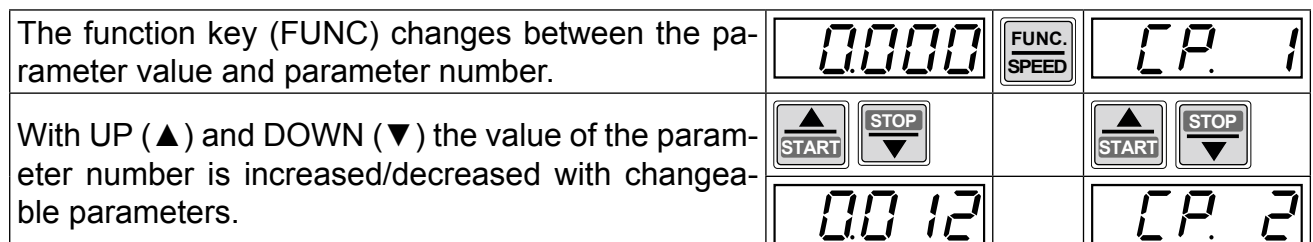

Connection and Operation

Principally during a change, parameter values are immediately accepted and stored non-volatile. However, with some parameters it is not useful that the adjusted value is accepted immediately. In these cases the adjusted value is accepted and stored non-volatile by pressing ENTER. A point is displayed behind the last digit if such a parameter is changed.

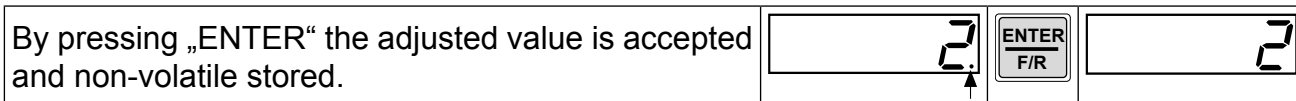

2.2.1.2 Resetting of error messages

If a malfunction occurs during operation, then the actual display is overwritten by the alarm message. The alarm message in the display is reset by ENTER.

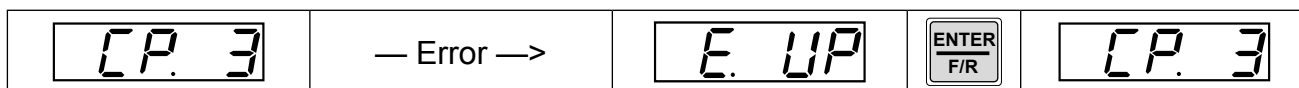

With ENTER only the error message in the display is reset. In order to reset the error itself, the cause must be removed and a reset or a power-on-reset must be made.

2.2.1.3 password input

The KEB COMBIVERT is provided with extensive password protection. Depending on the entered password the following modes are possible:

Display	Mode
CP_ro	End customer menu (CP-Parameter) read-only
CP_on	End customer menu (CP-Parameter) read/write
CP_SE	Service menu (like end customer menu, but with the original parameters)
APPL	Application menu (all parameter groups and parameters are visible)
–	Drive mode (COMBIVERT can be put into operation by the keyboard)

The permissible menu for the application is determined by the machine builder.

The password input is generally made over the parameter CP.00. The adjusted password/menu is maintained even after switching off.

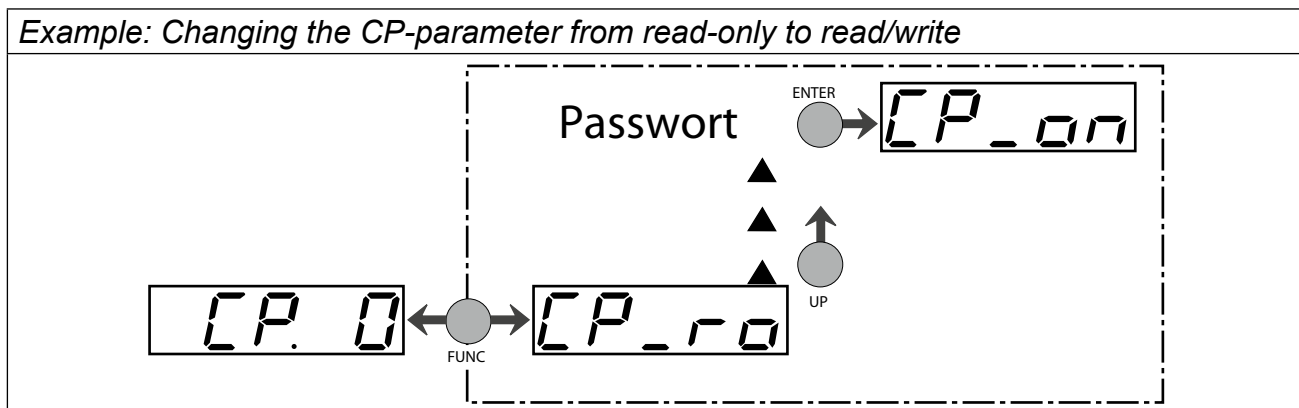

2.3 Interface operator (part number 00F5060-2000)

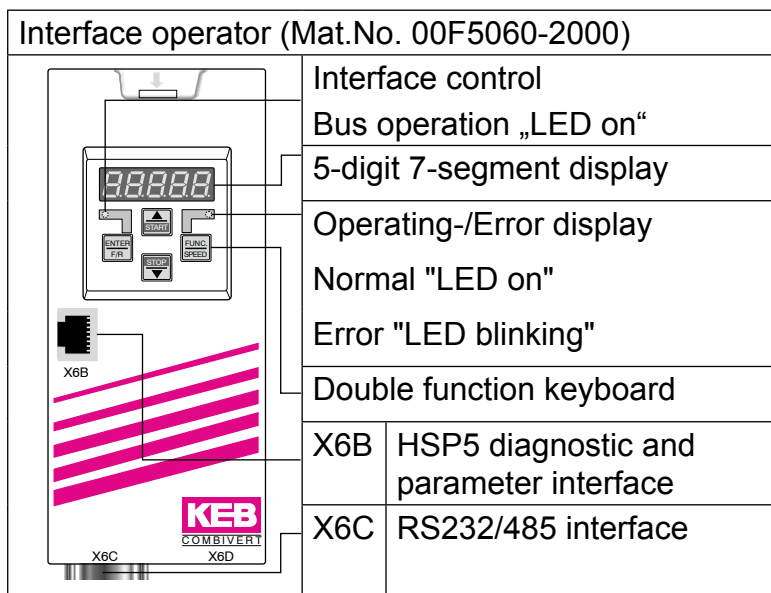

The interface operator corresponds to the functional range of the digital operator. However, it is extended by a serial RS232/485 interface and a diagnosis-/parameter interface.

2.3.1 Description of the diagnostic and parameter interface X6B

The HSP5 interface (X6B) enables access to the inverter for diagnostic or programming assignment. The HSP5 interface is designed as RJ45 socket. The diagnostic interface is connected to a PC via adapter (00F50C0-0020) and HSP5 cable (00F50C0-0010). Access to the inverter parameters in the application mode is possible via the PC software KEB COMBIVIS. The operator parameter can also be read and adjusted or parameterized via Download.

Required accessories:

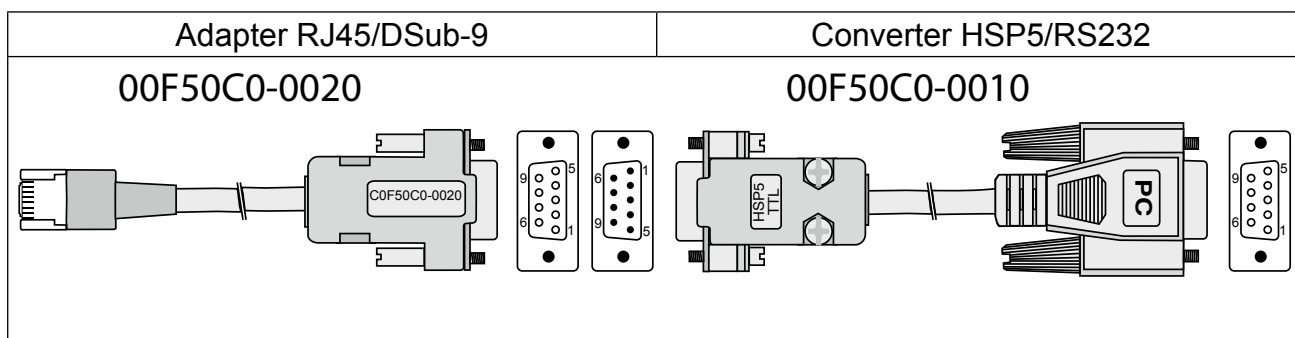

	<p>The RS232-HSP5 service cable has an integrated level converter. The connection of a serial standard cable would destroy the PC interface.</p>
--	--

Connection and Operation

2.3.2 Description of the RS232/485 interface X6C

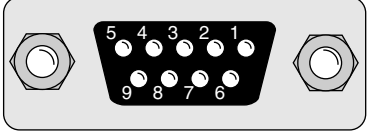
	PIN	RS485	Signal	Meaning
	1	-	-	reserved
	2	-	TxD	transmission signal RS232
	3	-	RxD	receive signal RS232
	4	A'	RxD-A	receive signal A RS485
	5	B'	RxD-B	receive signal B RS485
	6	-	VP	supply voltage +5V (I _{max} =50 mA)
	7	C/C'	DGND	Data reference potential
	8	A	TxD-A	transmission signal A RS485
	9	B	TxD-B	transmission signal B RS485

A RS232-cable is needed to connect the interface operator with the PC.

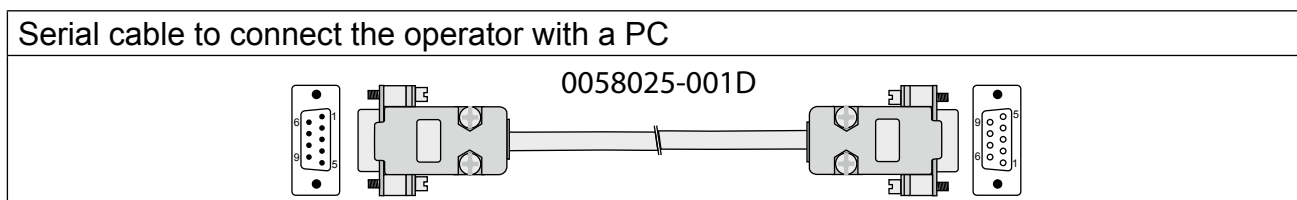

2.3.3 Remote control

For remote control of the KEB COMBIVERT F5 a special HSP5 operator is available. Hereby the operator is mounted separate from the inverter e.g. into the cabinet door.

Operator	Material number	suitable cable
F5 HSP5/485 connection DSUB-15	00F5060-9000	00F50C0-2xxx
F5 HSP5/485 connection screw terminal	00F5060-9001	00F50C0-3xxx
xxx The last three digits of the material number determine the cable length in dm.		

2.3.4 Other operators

Additionally to the described operators, the KEB COMBIVERT can be equipped with other operators for special applications (PROFIBUS, INTERBUS, SERCOS, CAN). You find further information on that on our home page.

3. Customer Parameters (CP-Mode)

3.1 General

Once the development stage of a machine is completed, usually only a few parameters are required for the adjustment or the control of the inverter. To make the handling easier and the user documentation more understandable as well as to increase the safety of operation against unauthorized access, the possibility exists to create the one user surface with the CP-Parameters. For that purpose 37 parameters (CP.00...CP.36) are available, 36 of them (CP.01...CP.36) are free for assignment.

How the CP-Parameters are defined and normalized is described in the application manual.

3.2 Operating modes

Ex factory the COMBIVERT F5 is delivered in three different operating modes. The inputs have different functions depending on the operation mode. Also the CP-Parameters predefined by KEB are different.

Control with software	Operating mode (Ud.02)
APPLICATION with encoder interface	MULTI
APPLICATION without encoder interface	GENERAL
ASCL (Asynchronous Sensorless Closed Loop)	MULTI
SCL (Synchronous Sensorless Closed Loop)	SERVO

The factory setting for the controls „BASIC“ and „COMPACT“ correspond to operating mode „GENERAL“.

Parameter Description

3.3 Factory setting for operating mode „GENERAL“

Parameter	Setting range	Resolution	Default	Unit	E	based on
CP.00	password input	0...9999	1	-	-	ud.01
CP.01	actual frequency display	-400...400	0,0125	0	Hz	ru.03
CP.02	set frequency display	-400...400	0,0125	0	Hz	ru.01
CP.03	inverter state	0...255	1	0	-	ru.00
CP.04	apparent current	0...6553,5	0,1	0	A	ru.15
CP.05	Apparent current / peak value	0...6553,5	0,1	0	A	ru.16
CP.06	utilization	0...65535	1	0	%	ru.13
CP.07	actual DC voltage	0...1500 B/C: 0...1000	1	0	V	ru.18
CP.08	peak DC voltage	0...1500 B/C: 0...1000	1	0	V	ru.19
CP.09	output voltage	0...1167 B/C: 0...778	1	0	V	ru.20
CP.10	min. frequency	0...400	0,0125	0	Hz	oP.06
CP.11	max. frequency forward	0...400	0,0125	70	Hz	oP.10
CP.12	acc. time forward	0,00...300,00	0,01	5	s	oP.28
CP.13	dec. time forward (-0.01 = CP.12)	-0,01...300,00	0,01	5	s	oP.30
CP.14	S-curve time	0,00...5,00	0,01	0,00 (off)	s	oP.32
CP.15	boost	0,0...25,5	0,1	LTK	%	uF.01
CP.16	rated frequency	0...400	0,0125	50	Hz	uF.00
CP.17	voltage stabilisation	1...1120 B/C: 1...650(off)	1	0	V	E uf.09
CP.18	switching frequency	2/4/8/12/16	1	LTK	kHz	E uF.11
CP.19	step value 1	-400...400	0,0125	5	Hz	oP.21
CP.20	step value 2	-400...400	0,0125	50	Hz	oP.22
CP.21	step value 3	-400...400	0,0125	70	Hz	oP.23
CP.22	DC braking mode	0...506 B/C: 0...9	1	7	-	E Pn.28
CP.23	DC braking time	0,00...100,00	0,01	10	s	pn.30
CP.24	Max. ramp current	0...200	1	140	%	Pn.24
CP.25	Max. constant current	0...200	1	200:off	%	Pn.20
CP.26	speed search condition	0...31 B/C: 0...15	1	8	-	E Pn.26
CP.27	quick stop dec time	0,00...300,00	0,01	2	s	Pn.60
CP.28	Response of ext. overtemperature.	0...9 B/C: 0...7	1	7	-	Pn.12
CP.29	ANOUT1 function	0...29 B/C: 0...26	1	2	-	E An.31
CP.30	ANOUT1 gain	-20,00...20,00	0,01	1	-	An.33
CP.31	relay output 1 / function	0...100 B/C: 0...84	1	4	-	E do.02

further on next side

Parameter	Setting range	Resolution	Default	Unit	E	based on
CP.32	relay output 2 / function 0...100 B/C: 0...84	1	27	-	E	do.03
CP.33	relay output 2 / switching level ±30000,00	0,01	4	-	-	LE.03
CP.34	rotation source 0...10 B/C: 0...9	1	2	-	E	oP.01
CP.35	AN1 interface selection 0...2	1	0	-	E	an.00
CP.36	AN1 zero clamp -10,0...10,0	0,1	0,2	%	-	An.04
LTK=depending on power unit; E=ENTER parameter						
B/C = Basic and Compact						

3.3.1 Password input

CP.00 Password input

Ex works the frequency inverter is supplied without password protection, this means that all changeable parameters can be adjusted. After parameterizing the unit can be barred against unauthorized access (Passwords: see last but one page). The adjusted mode is stored.

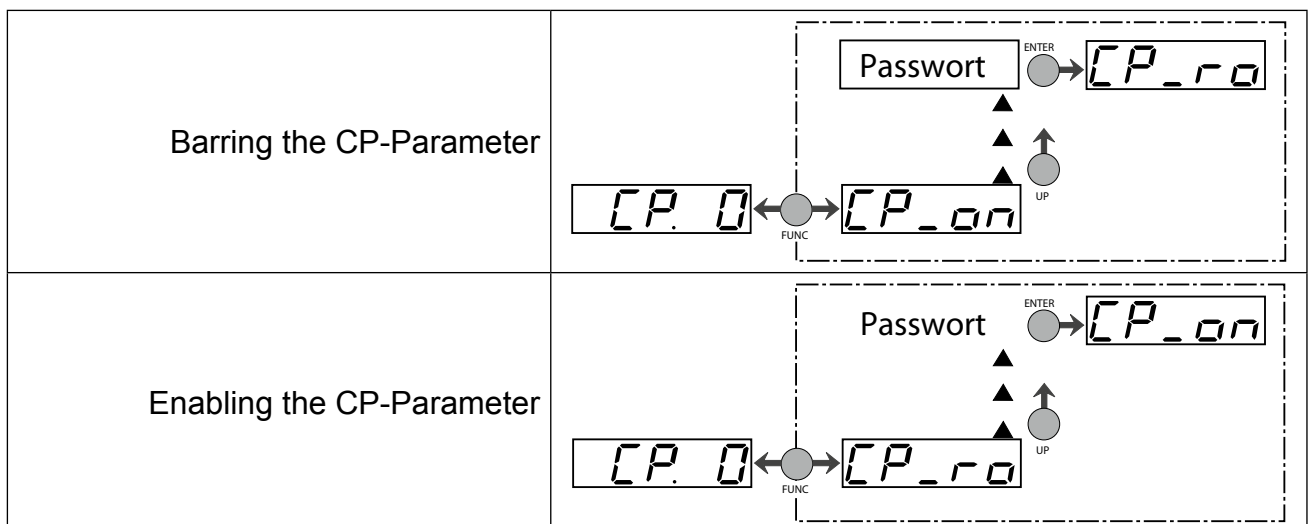

Parameter Description

3.3.2 Operating Display

The parameters below serve for the controlling of the frequency inverter during operation.

CP.01 Actual frequency display

Co-domain	Description
0...±400Hz	Display of the actual output frequency in Hz. Additionally the operator display "noP" and "LS", even if the control release or direction of rotation are not switched (see CP.03). The rotation of the inverter is displayed by the sign. Examples:
18.3	Output frequency 18,3 Hz, rotation forward
-18.3	Output frequency 18,3 Hz, rotation reverse

CP.02 Set frequency display

Co-domain	Description
0...±400Hz	Display of actually set value. For control reasons the set speed is displayed, even if the control release or direction of rotation is not switched. If no direction of rotation is set, the set frequency for clockwise rotation (forward) is displayed.

CP.03 Inverter state

The status display shows the actual working conditions of the inverter. Possible displays and their meanings are:

Display	Status
nOP	„no Operation“ control release not bridged; modulation switched off; output voltage = 0V; drive is not controlled.
LS	„Low Speed“ no direction of rotation preset; modulation switched off; output voltage = 0V; drive is not controlled.
Facc	"Forward Acceleration" drive accelerates with direction of rotation forward.
Fdec	„Forward Deceleration“ drive decelerates with forward direction.
racc	"Reverse Acceleration" drive accelerates with direction of rotation reverse.
rdec	"Reverse Deceleration" drive decelerates with direction of rotation reverse.
Fcon	"Forward Constant" drive runs with a constant speed and forward direction.
rcon	"Reverse Constant" drive runs with constant speed and reverse direction.

Other status messages are described at the parameters, where they occur (see chapter 5 „Error diagnosis“).

CP.04 Apparent current

Co-domain	Description
0...±6553.5A	Display of the actual apparent current in ampere.

CP.05 Apparent current / peak value

Co-domain	Description
0...±6553.5A	CP.05 makes it possible to recognize the max. apparent current. For that the highest value of CP.04 is stored in CP.05. The peak value memory can be cleared by pressing the UP, DOWN or ENTER key or via bus by writing any value you like to the address of CP.05. The switch off of the inverter also clears the memory.

CP.06 Utilization

Co-domain	Description
0,0...200,00 %	Display of the actual inverter rate of utilization in percent. 100% rate of utilization is equal to the inverter rated current. Only positive values are displayed, meaning there is no differentiation between motor and generator operation.

CP.07 Actual DC voltage

Co-domain	Description			
0...1500V	Display of actual DC-link voltage in volt. Typical values:			
Basic/Compact 0...1000V	V-class	Normal operation	Overvoltage (E.OP)	Undervoltage (E.UP)
	230V	290...360VDC	approx. 400V DC	approx. 216V DC
	400V	510...620VDC	approx. 800V DC	approx. 240V DC
	690V	880...1070VDC	approx. 1200V DC	approx. 360V DC

CP.08 Peak DC voltage

Co-domain	Description
0...1500V	CP.08 makes it possible to recognize short-time voltage rises within an operating cycle. For that the highest value of CP.07 is stored in CP.08. The peak value memory can be cleared by pressing the UP, DOWN or ENTER key or via bus by writing any value you like to the address of CP.08. The switch off of the inverter also clears the memory.
Basic/Compact 0...1000V	

CP.09 Output voltage

Co-domain	Description
0...1167V	Display of the actual output voltage in volt.
Basic/Compact 0...778V	

Parameter Description

3.3.3 Basic adjustment of the drive

The following parameters determine the fundamental operating data of the drive. They should be checked and/or adapted to the application.

CP.10 Min. frequency

Co-domain	Setting	Description
0.0...400.0Hz	0Hz	With this frequency the inverter operates without presetting an analog set value. Internal limiting of the fixed frequencies CP.19...CP.21.

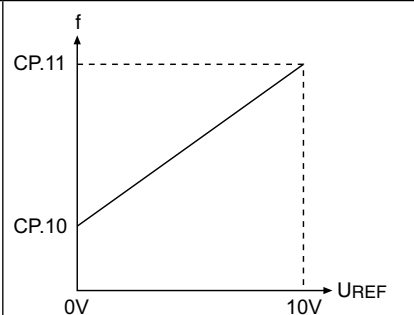

CP.11 Max. frequency forward

Co-domain	Setting	Description
0.0...400.0Hz	70Hz	With this frequency the inverter operates with maximum set value. Internal limiting of the fixed frequencies CP.19...CP.21. → CP.10

CP.12 Acc. time forward

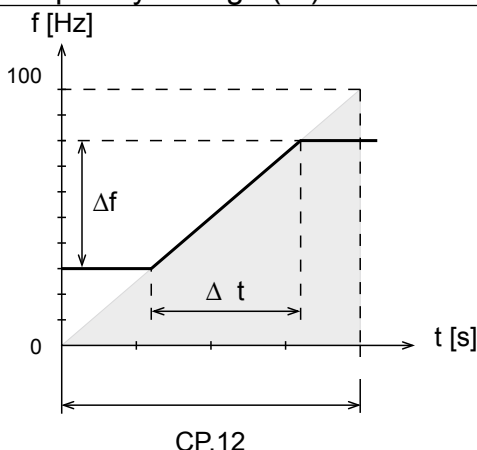
Co-domain	Setting	Description
0.00...300.00 s	5.00 s	The parameter determines the time needed to decelerate from 0 to 100 Hz. The actual acceleration time is proportional to the frequency change (Δf).
Δf Frequency change Δt Acceleration time for Δf t		
Example		<p>A drive shall accelerate from 10Hz to 60Hz in 5s.</p> <p>$\Delta f = 60\text{Hz} - 10\text{Hz} = 50\text{Hz}$ $\Delta t = 5\text{s}$</p> $\text{CP.12} = \frac{\Delta t}{\Delta n} \times 100\text{Hz} = \frac{5\text{s}}{50\text{Hz}} \times 100\text{Hz} = 10\text{s}$

CP.13 Deceleration time

Co-domain	Setting	Description
-0.01...300.00 s	5.00 s	The parameter determines the time needed to decelerate from 100 Hz to 0 Hz. The actual deceleration time is proportional to the frequency change. At deceleration time = -0,01 see CP.12 (Display: "=Acc")!
Δf Frequency change Δt Deceleration time for Δf t		
Example		<p>The drive should decelerate from 60 Hz to 10 Hz in 5 s.</p> <p>$\Delta f = 60 \text{ Hz} - 10 \text{ Hz} = 50 \text{ Hz}$ $\Delta t = 5 \text{ s}$</p> <p>$\text{CP.13} = \frac{\Delta t}{\Delta f} \times 100 \text{ Hz} = \frac{5 \text{ s}}{50 \text{ Hz}} \times 100 \text{ Hz} = 10 \text{ s}$</p>

Parameter Description

CP.14 S-curve time

Co-domain	Setting	Description
0.00 (off)...5.00s	0.00s (off)	For some applications it is of advantage when the drive starts and stops jerk-free. This is achieved through a straightening of the acceleration and deceleration ramps. The straightening time, also called S-curve time, can be adjusted with CP.14.
t1	S-curve time (CP.14)	 <p>In order to drive defined ramps with activated S-curve time, the acceleration and deceleration times (CP.12 and CP.13) must be adjusted higher than the S-curve time (CP.14).</p>
t2	Acceleration time (CP.12)	
t3	Deceleration time (CP.13)	

CP.15 Boost

Co-domain	Setting	Description
0,0...25,5%	LTK	<p>In the lower speed range a large part of the motor voltage decreases on the stator resistance. To keep the breakdown torque nearly constant over the entire speed range, the voltage decrease can be compensated by the Boost.</p> <p>Adjustment:</p> <ul style="list-style-type: none"> • Determine the rate of utilization in no-load operation • Preset about 10Hz and adjust the boost, by way that the same rate of utilization is reached as with rated speed.
		When the motor, during continuous operation, drives with low speed and too high voltage it can lead to an overheating of the motor.

*) dependent on power circuit

CP.16 Rated frequency

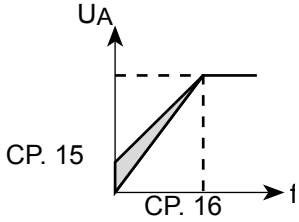
Co-domain	Setting	Description
0.00...400.00 Hz	50 Hz	With the adjusted frequency the inverter reaches in controlled operation a maximal output voltage. The adjustment of the rated motor frequency is typical in this case.
	Motors can overheat when the rated frequency is incorrectly adjusted.	

3.3.4 Special Adjustments

The following parameters serve for the optimization of the drive and the adaption to certain applications. These adjustments can be ignored at the initial start-up.

CP.17 Voltage stabilisation

Co-domain	Setting	Description
GENERAL 1...1120 V (off)	1120 V (off)	With this parameter a regulated output voltage in relation to the rated frequency can be adjusted. Voltage fluctuations at the input and in the DC link have only low influence on the output voltage (V/f characteristic). The function allows an adaption of the output voltage to special motors. The values must be confirmed with „ENTER“.
Basic / Compact 1...650 V (off)	650 V (off)	

In the example below the output voltage is stabilized to 230 V (0% boost).

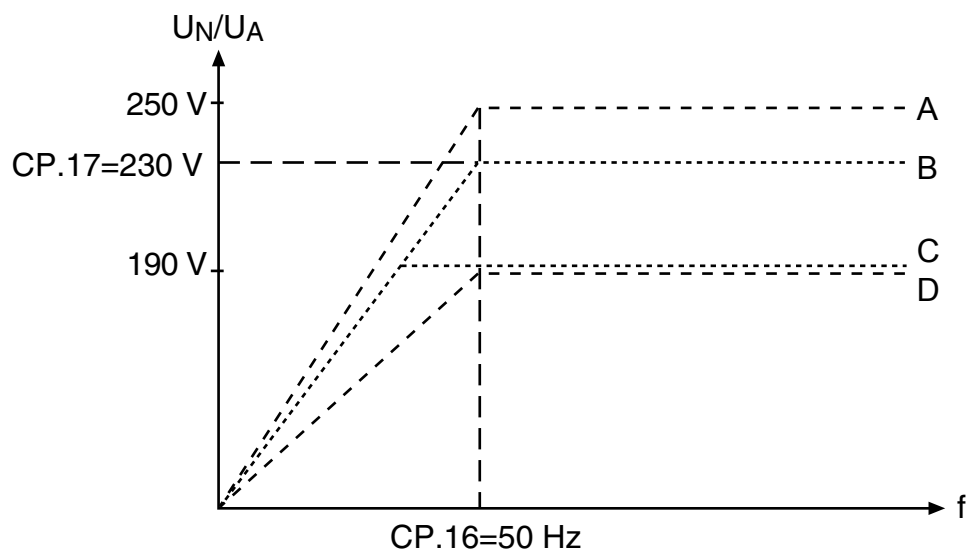

UN: Mains voltage
UA: output voltage

A: UA at UN = 250V unstabilized
B: UA at UN = 250V stabilized
C: UA at UN = 190V stabilized
D: UA at UN = 190V unstabilized

Parameter Description

CP.18 Switching frequency

Co-domain	Setting	Description	
2 / 4 / 8 / 12 / 16 kHz	LTK	The switching frequency with which the power modules are clocked can be changed depending on the application. The max.possible switching frequency as well as the factory setting are specified by the power circuit. The values must be confirmed with „ENTER“.	
Refer to following list to learn about influences and effects of the switching frequency.		low switching frequency	high switching frequency
		less inverter heating	less noise development
		less discharge current	improved sine-wave simulation
		less switching losses	less motor losses
		less radio interferences	improved controller characteristics
		improved concentricity with low speed (only open loop!)	
	At switching frequencies above 4 kHz pay absolute attention to the max. motor line length in the technical data of the power circuit manual.		

CP.19 Fixed frequency 1 (input 1)

CP.20 Fixed frequency 2 (input 2)

CP.21 Fixed frequency 3 (input 2)

Co-domain	Setting	Description
CP.19	5 Hz 50 Hz 70 Hz	Three fixed frequencies can be adjusted. The selection is made by the inputs I1 and I2. If adjustments are made that are outside the fixed limits of CP.10 and CP.11, then the frequency is internally limited. The negative values are released in application mode. The rotation source of the fixed frequencies is not changed by CP.34, it always corresponds to CP.34 = 2.
CP.20		
CP.21		
0...±400Hz		
	Input I1	==> Fixed frequency 1
	Input I2	==> Fixed frequency 2
	Input I1 and I2	==> Fixed frequency 3

CP.22 DC braking mode

During the DC braking the motor is not decelerated over the ramp. Fast braking occurs via DC voltage which is applied to the motor winding. This parameter determines how the DC braking is triggered. The selection must be confirmed with „ENTER“.

Value	Bit	Value	Function
0	0...3	no DC braking	DC-braking deactivated
1		no direction of rotation and actual value = 0	DC braking at disabling the direction of rotation and reaching 0 Hz. The braking time is CP.23 or until the next direction of rotation.
2		disabling the direction of rotation	DC-braking as soon as setting for the direction of rotation is absent.
3		Change of direction of rotation	DC-braking as soon as the direction of rotation changes or is absent.
4	0...3	no direction of rotation	DC-braking on disabling the direction of rotation and if the real frequency falls below 4 Hz.
5		Deceleration	DC-braking when the real frequency falls below 4 Hz and the drives decelerates
6		Setpoint < Pn.32	DC-braking as soon as the set value falls below 4 Hz.
7		Digital input time-limited	DC-braking when input I4 is switched. At control circuit B = value "0"
8		as long as the digital input is set	DC-braking when input I4 is switched. At control circuit B = value "0"
9		at start of the modulation	DC braking after switching the modulation.
10		Conditions	DC braking according to the conditions programmed in bit 4..7.
11...15			reserved
16	4	DCB after nop	DC braking after status "0: no control release"
32	5	DCB at switch on	DC braking after power-on-reset (power on)
64	6	DCB at reset	DC braking after reset
128	7	DCB for auto-retry	DC braking after automatic restart
256	8	DCB after LS	DC braking after status "70: standstill"

Parameter Description

CP.23 DC braking time

Co-domain	Setting	Description
0.00...100.00s	10s	If the braking time depends on the actual frequency (CP.22 = 2...7), it is calculated as follows:
$t_B = \frac{CP.23 \times f_B}{100 \text{ Hz}}$		
t _B : Real braking time f _B : Actual frequency		

CP.24 Maximum ramp current

Co-domain	Setting	Description
0...200 %	140 %	This function protects the frequency inverter against switching off through overcurrent during acceleration. When the ramp reaches the adjusted value, it is stopped so long until the current decreases again. CP.03 displays "LAS" at active function.

CP.25 Maximum constant current

Co-domain	Setting	Description
0...200 % (off)	200 % (off)	This function protects the frequency inverter against switching off through overcurrent at constant output frequency. Upon exceeding of the adjusted value, the output frequency is reduced as long as the value falls below. "SLL" is displayed (CP.03) with active function.
further on next side		

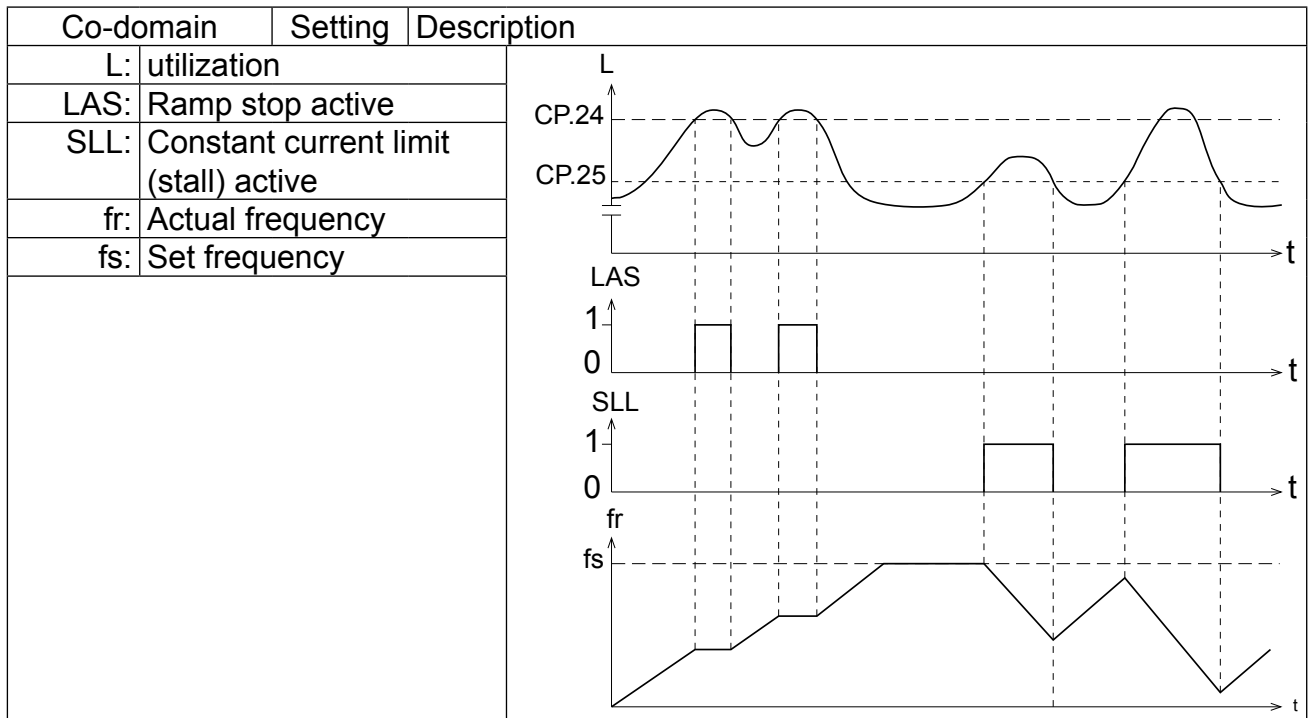

CP.26 Speed search condition

When connecting the frequency inverter onto a decelerating motor, an error can be triggered by the differing rotating field frequencies. With activated speed search the inverter searches for the actual motor speed, adapts its output frequency and accelerates with the adjusted ramp to the given set value. During speed search CP.03 displays "SSF". The parameter determines the conditions for the function. In case of several conditions the sum of the value must be entered. The selection must be confirmed with „ENTER“.

Value	Setting	Function
0		Function off
1		at control release
2		at switch on
4		after reset
8	x	after auto reset
16		Speed search after the status "standstill (modulation off)"
Example:		CP.26 = 12 means after reset and after autoreset UP.

Parameter Description

CP.27 Quick stop dec time

Co-domain	Setting	Description
0.00...300.00 s	2.00 s	The fast-stop function is activated depending on CP.28. The parameter determines the time needed to decelerate from 100 Hz to 0 Hz. The actual deceleration time is proportional to the frequency change. The response to over-temperature (CP.28) is disabled in the factory setting. If it is activated the modulation automatically switches off after 10 s, if the motor is still too hot.
Example:		see parameter CP.13

CP.28 Response of external overtemperature

This parameter determines the response of the drive to the external temperature monitoring. To activate the function, the power circuit terminals T1/T2 must be connected in accordance with the power circuit manual. The response can be adjusted according to following table.

Value	Addition	Setting	Display	Reaction	Restart
0		x	E.dOH	Immediate disabling of modulation	Remove fault, Actuate reset
1	x		A.dOH	Quick stopping; disabling of modulation after reaching frequency 0	
2	x			Quick stopping; holding torque at speed 0	
3				Immediate disabling of modulation	Autoreset, if the fault is no longer present
4	x		Quick stopping; disabling of modulation after reaching speed 0		
5	x		Quick stopping; holding torque at speed 0		
6	x		—	No effect to the drive; an external module can be controlled with CP.3132 = 9 (e.g. fan)	—
7			—	No effect to the drive; Malfunction is not present; external temperature monitoring is not activated.	
If the motor is still too hot after 10 seconds, error E.dOH is triggered and the modulation is switched off!					
			If overheat no longer exists, the message E.ndOH (or A.ndOH) is output. Only then the error can be reset or the automatic restart can be carried out.		

CP.29 ANOUT1 function

CP.29 defines the function of analog output 1. The selection must be confirmed with „ENTER“.

Value	Setting	Reaction	Output
0		Absolute actual frequency (CP.01)	100 Hz = 100 %
1		Absolute set frequency (CP.02)	100 Hz = 100 %
2	x	Actual frequency (CP.01)	$\pm 100 \text{ Hz} = \pm 100 \%$
3		Set frequency (CP.02)	$\pm 100 \text{ Hz} = \pm 100 \%$
4		Output voltage (CP.09)	500 V = 100 %
5		DC link voltage (CP.07)	1000 V = 100 %
6		Apparent current (CP.04)	2 x rated current = 100 %
7		Active current	$\pm 2 \text{ x rated current} = \pm 100 \%$
8...10		Only application mode	—
11		absolute active current	2 x rated current = 100 %
12		Power module temperature	100 °C = 100 %
13		drive overheat	100 °C = 100 %
14...18		Only application mode	—
19		Ramp output frequency	$\pm 100 \text{ Hz} = \pm 100 \%$
20		Absolute ramp output frequency	100 Hz = 100 %
21		Only application mode	—
22		Only application mode	—
23		Only application mode	—
24		Only application mode	—
25		Only application mode	—
26		Active power	—
27		Actual position	—
28		Set position	—
29		actual torque referred to the max. permissible torque of the drive chain	—
These values are not available at control type „BASIC“!			

Parameter Description

CP.30 ANOUT1 gain

Co-domain	Setting	Description
-20,00...20,00	1,00	With the amplification the output voltage of the analog output can be tuned the signal to be given out. An amplification of 1 corresponds to $\pm 100\% = \pm 10V$.
<p>Example: The analog output shall give out +10V at 70% instead at 100%.</p> $\text{CP.30} = \frac{100\%}{70\%} = 1,43$		

CP.31 Relay output 1 / function**CP.32 Relay output 2 / function**

CP.31 and CP.32 determine the function of the two outputs. The values must be confirmed with „ENTER“.

Value	Setting	Function
0		off
1		on
2		Run signal; also by DC braking
3		No error
4	CP.31	error message
5		Fault relay (not at under voltage error)
6		Quick stopping / error
7		OL warning
8		OH warning
9		External overtemperature alert signal motor
10		Only application mode
11		Overtemperature alert signal interior OHI
12		Only application mode
13		Actual value = set value (CP.03 = Fcon; rcon; not at noP, LS, error, SSF)
14		Accelerate (CP.03 = FAcc, rAcc, LAS)
15		Decelerate (CP.03 = FdEc, rdEc, LdS)
16		Real direction of rotation = set direction of rotation
17		Utilization > switching level ¹⁾
18		Active current > switching level ¹⁾
19		Only application mode
20	CP.32	Real value (CP.01) > switching level ¹⁾
21		Setpoint (CP.02) > switching level ¹⁾
22		Only application mode
23		Absolute setpoint at AN1 > switching level ¹⁾
24		Absolute setpoint at AN2 > switching level ¹⁾
25		Only application mode
26		Set value at AN1 > switching level ¹⁾
27		Set value at AN2 > switching level ¹⁾
28		Only application mode
29		Hardware current limit activated
30		Modulation on-signal
31		Only application mode
32		Ramp output value > switching level ¹⁾
33		Apparent current (CP.04) > switching level ¹⁾
34		Forward running (not at nOP, LS, abnormal stopping or error)
35		Reverse running (not at nOP, LS, abnormal stopping or error)
36		Only application mode
37		ru.43 „timer 1 display“ or ru.44 „timer 2 display“ > switching level
38		further on next side

Parameter Description

Value	Setting	Function
39		Amount ru.58 „angle difference“ > switching level (observe only in posi- or synchronous mode / scaling factor of the LE-Parameters for increments)
40		Absolute value ANOUT1 > level ¹⁾
41		modulation on
42		Output of the analog signal ANOUT 3 or ANOUT 4 as PWM signal. The period can be adjusted with An.46 or An.52.
43		
44		Number of the inverter state (e.g. 18 at error! Watchdog) = switching level
45		Power module temperature (ru.38) > switching level
46		Motor temperature (ru.46) > switching level
47		Amount ramp output display (ru.02) > switching level
48		Apparent current (ru.15) > switching level
49		current rotation direction clockwise rotation and counter clockwise rotation, respectively (only set if ramp generator is active.
50		
51		When exceeding level Pn.9 (default 80%) overload pre-warning OL2 is output. The response in case of a warning can be adjusted with Pn.8 (response to OL-warning).
52		Current and speed controller in limit (not in v/f characteristic controlled operation).
53		
54		The position profile is completed (ru.56 = ru.61) and the drive is in the range of +/- PS.30 / 2 (target window) around the target position ru.61.
55		ru.54 „actual position“ > switching level (observe scaling factor of the levels: 1.00 = 100 increments).
56		Positioning is active, but the set position ru.56 has not yet reached the target position ru.61. The output is deactivated, as soon as the calculated position profile has reached the target position (ru.56 „set position“ = ru.61 „target position“), even if the drive has not reached the target window.
57		The position is inaccessible from the current speed under the restrictions of the adjusted deceleration and S-curve times or a new "start positioning" command was sent during the deceleration ramp.
58		This output switching condition is needed for the follow-up positioning. The output is set if the result of all selected inputs is 1. The internal state of the inputs (displayed in ru.22 „internal input state“) is significant for the linkage. The output is set with „start positioning“ and only deactivated if ru.56 „set position“ has reached the last block of the target position. (In parameter PS.26 „index/ next“ of the last block value „-1: PS.28“ must be entered).
		further on next side

Value	Setting	Function																										
		Function																										
		Switching condition met if:																										
		AND																										
		or																										
		NAND																										
59		The selection of inputs to be linked occurs via the comparison level parameters LE.00...LE.07.																										
60																												
61																												
62																												
		<table border="1"> <thead> <tr> <th>Input</th> <th>ST</th> <th>RST</th> <th>F</th> <th>R</th> <th>I1</th> <th>I2</th> <th>I3</th> <th>I4</th> <th>IA</th> <th>IB</th> <th>IC</th> <th>ID</th> </tr> </thead> <tbody> <tr> <td>Value</td> <td>1</td> <td>2</td> <td>4</td> <td>8</td> <td>16</td> <td>32</td> <td>64</td> <td>128</td> <td>256</td> <td>512</td> <td>1024</td> <td>2048</td> </tr> </tbody> </table>	Input	ST	RST	F	R	I1	I2	I3	I4	IA	IB	IC	ID	Value	1	2	4	8	16	32	64	128	256	512	1024	2048
Input	ST	RST	F	R	I1	I2	I3	I4	IA	IB	IC	ID																
Value	1	2	4	8	16	32	64	128	256	512	1024	2048																
		The sum of the inputs to be queried is entered in the switching levels. Example: If R and I1 shall be linked for condition 0 F, value $4 + 8 + 16 = 28.00$ must be entered in LE.00.																										
63		Amount of ANOUT1 (amount of ru.34 „ANOUT1 post ampl. display) or ANOUT 2 (amount of ru.36 „ANOUT2 post ampl. display) higher than the switching level																										
64																												
65		ANOUT1 (ru.34 „ANOUT1 post ampl. display) or ANOUT 2 (ru.36 „ANOUT2 post ampl. display) higher than the switching level																										
66																												
67		Distance since the last "start positioning" command is longer than the adjusted level. If the positioning is completed, the output is reset.																										
68		The output is set, if the distance to be covered to the target is larger than the adjusted level.																										
69		Amount of the system deviation of the external PID controller > switching level																										
70		For inverters with safety relay: The driver voltage for control of the power module is active.																										
71		Synchronization phase after activation of synchronous running completed (no display that there is angle-synchronization between slave and master).																										
72		ru. 60 „actual position index“ is equal to the switching level (scaling factor: values of 0.51...1.5 count as index 1 etc.)																										
73		Amount ru.81 „active power“ > switching level																										
74		ru.81 „active power“ > switching level																										
75		ru.54 „actual position“ – ru.71 „teach/scan position display“ > switching level																										
76		reserved																										
77		ru.60 „actual position index“ = PS.28 „start index new profile“ and target window of this positioning reached.																										
78		At flying referencing in a rotary table application a reference signal is recognized outside the position window of +/- PS.40 „refpoint window“.																										
79		Distance since the last "start positioning" command is longer than the adjusted level. If the positioning is completed, the output is reset.																										
		further on next side																										

Parameter Description

Value	Setting	Function
80		The output is set, if the distance to be covered to the target is larger than the adjusted level.
81		Amount ru.09 „encoder 1 speed“ or ru.10 „encoder 2 speed“ > switching level.
82		
83		HSP5 bus synchronizes; corresponds status word bit 9 (SY.51)
84		Amount ru.07 „actual value display“ is smaller than oP.06 „min.reference forward“ at forward or oP.07 „min.reference reverse“ at reverse.
85		The input triggering „warning! external input“ or „error! external input“ is active (the inverter state has no effect).
86		The watchdog (HSP5 watchdog SY.09 or operator watchdog Pn.06) has triggered (status of the drive has no influence).
87		The acceleration has exceeded the value of parameter Pn.79 "acceleration limit of 1/s ² ". Parameter Pn.80 „acceleration scan time“ determines the time period used for acceleration averaging. The speed difference must be converted from 1/min to 1/s for the calculation of the acceleration. *
88		Prewarning level for an overload protection function which monitors the motor or the inverter is exceeded. Warnings 7(OL), 8(OH), 9(dOH), 11(OHI), 10(OH2), 51(OL2) are integrated in this switching condition (OR operation). Additionally this switching condition has the following function: If „auto retry E.UP“ is activated in Pn.00 and if a limit for the retry function is adjusted in Pn.76 „max. E.UP warning time“, the switching condition is active during the warning time (that means the time when an auto retry is executed).
89		ru.07 „actual value display“ is smaller than switching level / 100 x ru.02 „ramp output display“. This switching condition is not active when the modulation is switched off and at special functions like e.g. speed search.
90		The switching condition is met when the motor temperature for the Rs correction (dr.51) is higher than the switching level.
91		If the setting „warning“ is programmed in EC.42 „encoder alarm mode“ „error! encoder“ is not triggered. Instead a warning signal can be generated via this switching condition.

1) Switching level of CP.31 = 100; The switching level of CP.32 is adjusted by CP.33.

CP.33 Relay output 2 / switching level

Co-domain	Setting	Description
-30000,00...30000,00	4,00	This parameter determines the switching level for the relay output 2 (CP.32). After the switching of the relay, the value can move within a window (hysteresis), without the relay dropping off. Since the operator can display only 5 characters, the last digits are not represented in the case of higher values.
Output variable		Hysteresis
Frequency		0.5 Hz
actual DC voltage		1 V
Analog set value		0,5 %
Active current		0.5 A
Temperature		1 °C

CP.34 Rotation source

Description		
The source rotation setting and the mode of evaluating the rotation setting is defined with this parameter. The rotation source of the fixed frequencies (CP.19...CP.21) is not changed with CP.34. The selection must be confirmed with „ENTER“.		
Value	Setting	Direction of rotation
0...1		Only application mode
2	x	Setting by way of terminal strip forward/reverse; negative set values are set to zero.
3		Setting by way of terminal strip forward/reverse; the signs of the set values have no effect on the direction of rotation.
4		Setting via terminal block run/stop and forward/reverse; negative set values are set to zero.
5		Setting via terminal block run/stop and forward/reverse; the sign of the set point values have no effect on direction of rotation.
6		Set value dependent; positive value = clockwise rotation; negative values = reverse. Status "Low speed" (LS) if no terminal For or Rev is active.
7		Set value dependent; positive value = clockwise rotation; negative values = reverse; forward is displayed at set value "0"
8...10		Only application mode
<p>Setpoint 0-limited (value 2 and 4)</p>		<p>Setpoint absolute (value 3 and 5)</p>

Parameter Description

CP.35 AN1 interface selection

Description		
The setpoint input 1 (AN1) can be triggered by various signal levels. In order to correctly evaluate the signal, this parameter must be adapted to the signal source. The selection must be confirmed with „ENTER“.		
Value	Setting	Direction of rotation
0	x	0...±10 VDC / Ri = 56 kΩ
1		0...±20 mADC / Ri = 250 Ω
2		4...20 mADC / Ri = 250 Ω
The signal source may not be changed in control type "BASIC" in housing A and B.		

CP.36 AN1 zero clamp

Co-domain	Setting	Description
-10,0...10,0 %	0,2 %	<p>Through capacitive as well as inductive coupling on the input lines or voltage fluctuations of the signal source, the motor connected to the inverter can still drift (tremble) during standstill in spite of the analog input filter. It is the task of the zero point hysteresis to suppress this.</p> <p>With parameter CP.36 the analog signal for the input REF can be faded out in the range of 0...±10%. The adjusted value is applicable for both directions of rotation.</p> <p>If a negative percent value is adjusted the hysteresis acts in addition to the zero point around the current setpoint. Setpoint changes at constant running are accepted only if they are larger than the adjusted hysteresis.</p>

3.4 Factory setting for operating mode „MULTI“

Parameter	Setting range	Resolution	Default	Unit	E	based on
CP.00	password input	0...9999	1	–	–	ud.01
CP.01	encoder 1 speed	±4000	0,125	0	rpm	– ru.09
CP.02	set value display	±4000	0,125	0	rpm	– ru.01
CP.03	inverter state	0...255	1	0	–	– ru.00
CP.04	apparent current	0...6553,5	0,1	0	A	– ru.15
CP.05	peak apparent current	0...6553,5	0,1	0	A	– ru.16
CP.06	actual torque	±32000,00	0,01	0	Nm	– ru.12
CP.07	actual DC voltage	0...1500	1	0	V	– ru.18
CP.08	peak DC voltage	0...1500	1	0	V	– ru.19
CP.09	output voltage	0...1167	1	0	V	– ru.20
CP.10	speed control configuration	0(off)...127	1	0 (off)	–	– cS.00
CP.11	DASM rated speed	0...64000	1	LTK	rpm	– dr.01
CP.12	DASM rated frequency	0,0...1600,0	0,1	LTK	Hz	– dr.05
CP.13	DASM rated current	0,0...1500,0	0,1	LTK	A	– dr.00
CP.14	DASM rated voltage	120...830	1	LTK	V	– dr.02
CP.15	DASM cos (phi)	0,50...1,00	0,01	LTK	–	– dr.04
CP.16	DASM rated power	0,10...1000,00	0,01	LTK	kW	– dr.03
CP.17	load mot. dependent para.	0...3	1	0	–	E Fr.10
CP.18	boost	0,0...25,5	0,1	LTK	%	– uF.01
CP.19	rated frequency	0...400	0,0125	50	Hz	– uF.00
CP.20	encoder 1 (inc/r)	1...65535	1	GBK	Inc	E Ec.01
CP.21	encoder 1 rotation	0...19	1	0	–	E Ec.06
CP.22	Maximum speed	0...4000	0,125	2100	rpm	– oP.10
CP.23	step value 1	±4000	0,125	100	rpm	– oP.21
CP.24	step value 2	±4000	0,125	-100	rpm	– oP.22
CP.25	acc. time forward	0,00...300,00	0,01	5,00	s	– oP.28
CP.26	deceleration time (-0.01=CP.25)	-0,01...300,00	0,01	5,00	s	– oP.30
CP.27	S-curve time	0.00(off)...5.00	0,01	0.00(off)	s	– oP.32
CP.28	Torque reference source	0...6	1	2	–	E cS.15
CP.29	absolute torque reference	±32000,00	0,01	LTK	Nm	– cS.19
CP.30	KP speed	0...32767	1	300	–	– cS.06
CP.31	KI speed	0...32767	1	100	–	– cS.09
CP.32	switching frequency	2/4/8/12/16 (LTK)	1	LTK	kHz	E uF.11
CP.33	relay output 1 / function	0...100	1	4	–	E do.02
CP.34	relay output 2 / function	0...100	1	2	–	E do.03
CP.35	Limit switch / stopping mode	0...6	1	6	–	– Pn.07
CP.36	External Fault / stopping mode	0...6	1	0	–	– Pn.03

LTK = dep. on power circuit (see chapter 3.4.5);E=ENTER parameter
GBK= encoder Id

Parameter Description



Due to the calculation / measuring accuracies, tolerances with the current and torque displays as well as with the switching levels and limitations, must be taken into consideration. The given tolerances (see parameter description) refer to the respective maximum values with the dimensioning KEB COMBIVERT : Motor = 1 : 1.

Dependent on the data from the motor manufacturer, larger tolerances at the torque displays are possible, due to the usual variations in the machine parameters and temperature drifts.

3.4.1 Password input

CP.00 Password input

Ex works the frequency inverter is supplied without password protection, this means that all changeable parameters can be adjusted. After parameterizing the unit can be barred against unauthorized access (Passwords: After parameterizing the unit can be barred against unauthorized access (Passwords: chapter Passwords).

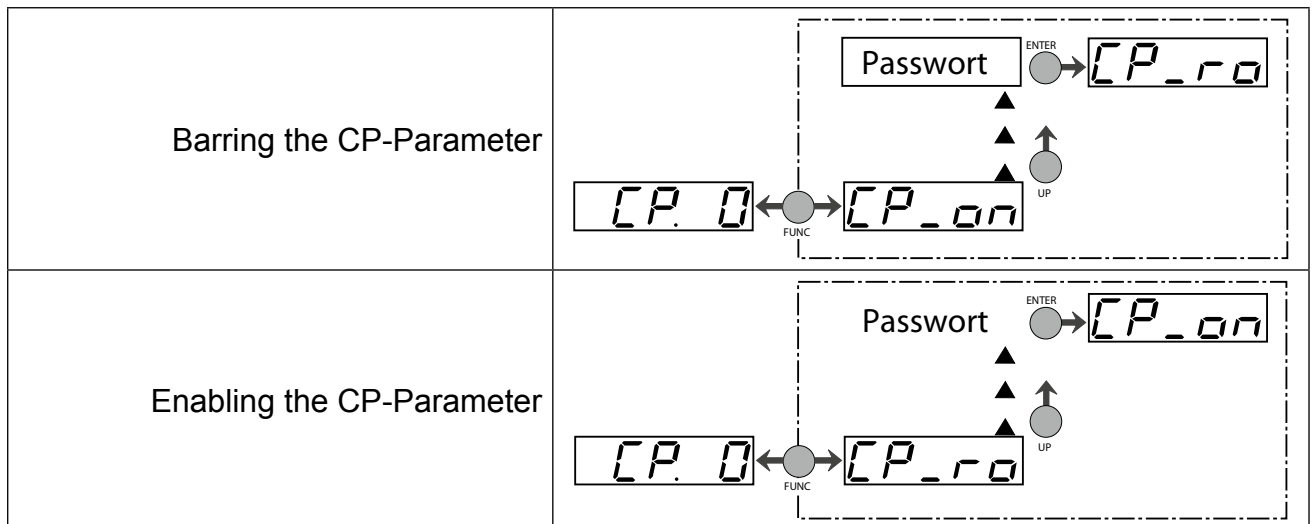

3.4.2 Operating Display

The parameters below serve for the controlling of the frequency inverter during operation.

CP.01 Encoder 1 speed

Co-domain	Description
0...±4000 rpm	Display of actual motor speed (incremental encoder 1). For control reasons the encoder speed is displayed, even if the control release or direction of rotation are not switched. A counter-clockwise rotating field (reverse) is represented by a negative sign. Precondition for the correct display value is the in-phase connection of the motor and the correct setting of the encoder line number (CP.20) as well as the direction of rotation (CP.21).

CP.02 Set value display

Co-domain	Description
0...±4000 rpm	Display of actually set value. For control reasons the set speed is displayed, even if the control release or direction of rotation are not switched. If no direction of rotation is set, the set speed for clockwise rotation (forward) is displayed.

CP.03 Inverter state

The status display shows the actual working conditions of the inverter. Possible displays and their meanings are:

nOP	„no Operation“ control release not bridged; modulation switched off; output voltage = 0V; drive is not controlled.
LS	„Low Speed“ no direction of rotation preset; modulation switched off; output voltage = 0V; drive is not controlled.
FAcc	"Forward Acceleration" drive accelerates with direction of rotation forward.
FdEc	„Forward Deceleration“ drive decelerates with forward direction.
rAcc	"Reverse Acceleration" drive accelerates with direction of rotation reverse.
rdEc	"Reverse Deceleration" drive decelerates with direction of rotation reverse.
Fcon	"Forward Constant" drive runs with a constant speed and direction of rotation forward.
rcon	"Reverse Constant" drive runs with constant speed and direction of rotation reverse.

Other status messages are described at the parameters, where they occur (see chapter 5 „Error diagnosis“).

Parameter Description

CP.04 Apparent current

Co-domain	Description
0...±6553.5A	Display of the actual apparent current in ampere.

CP.05 Apparent current / peak value

Co-domain	Description
0...±6553.5A	CP.05 makes it possible to recognize the max. apparent current. For that the highest value of CP.04 is stored in CP.05. The peak value memory can be cleared by pressing the UP, DOWN or ENTER key or over bus by writing any value you like to the address of CP.05. The switch off of the inverter also clears the memory.

CP.06 Actual torque

Co-domain	Description
0.0...±10000A	<p>The displayed value corresponds to the actual motor torque in Nm. The value is calculated from the active current. Because of normal type differences and temperature deviations of the motors, tolerances of up to 30 % are possible in the base speed range (see reference at 3.4).</p> <p>Requirement for the torque display is the adjustment of the motor data (CP.11...CP.16). If the real motor data deviate strongly from the data on the name plate the operating performance can be optimized by entering the real data. The adjustment of the name plate data is sufficient for a start-up.</p>

CP.07 Actual DC voltage

Co-domain	Description																
0...1500V	Display of actual DC-link voltage in volt. Typical values:																
	<table border="1"><thead><tr><th>V-class</th><th>Normal operation</th><th>Oversvoltage (E.OP)</th><th>Undervoltage (E.UP)</th></tr></thead><tbody><tr><td>230V</td><td>300...330V DC</td><td>approx. 400V DC</td><td>approx. 216V DC</td></tr><tr><td>400V</td><td>530...620V DC</td><td>approx. 800V DC</td><td>approx. 240V DC</td></tr><tr><td>690V</td><td>880...1070VDC</td><td>approx. 1200V DC</td><td>approx. 360V DC</td></tr></tbody></table>	V-class	Normal operation	Oversvoltage (E.OP)	Undervoltage (E.UP)	230V	300...330V DC	approx. 400V DC	approx. 216V DC	400V	530...620V DC	approx. 800V DC	approx. 240V DC	690V	880...1070VDC	approx. 1200V DC	approx. 360V DC
	V-class	Normal operation	Oversvoltage (E.OP)	Undervoltage (E.UP)													
	230V	300...330V DC	approx. 400V DC	approx. 216V DC													
	400V	530...620V DC	approx. 800V DC	approx. 240V DC													
690V	880...1070VDC	approx. 1200V DC	approx. 360V DC														

CP.08 Peak DC voltage

Co-domain	Description
0...1500V	CP.08 makes it possible to recognize short-time voltage rises within an operating cycle. For that the highest value of CP.07 is stored in CP.08. The peak value memory can be cleared by pressing the UP, DOWN or ENTER key or over bus by writing any value you like to the address of CP.08. The switch off of the inverter also clears the memory.

CP.09 Output voltage

Co-domain	Description
0...1167V	Display of the actual output voltage in volt.

3.4.3 Basic adjustment of the drive

The following parameters determine the fundamental operating data of the drive and must be adjusted for the initial start-up (see chapter "Start-up"). They should be checked and/or adapted to the application.

CP.10 Speed control configuration

Value	Setting	Function	Description
0	x	off (open-loop operation)	With this parameter the basic setting of the speed controller is determined.
1		reserved	
2		reserved	
3		off (open-loop operation)	
4		Speed control (closed loop operation)	
5		Torque control (closed loop operation)	
6		Torque-/speed control (closed loop operation)	
7...127		off (open-loop operation)	

CP.11 DASM rated speed

Co-domain	Setting	Description
0...64000 rpm	see 3.4.5	Adjustment of rated motor speed according to the name plate. The factory setting depends on the unit size.

CP.12 DASM rated frequency

Co-domain	Setting	Description
0.0...1600.0 Hz	see 3.4.5	Adjustment of the rated motor frequency according to the name plate. The factory setting depends on the unit size.

CP.13 DASM rated current

Co-domain	Setting	Description
0.0...1500.0 A	see 3.4.5	Adjustment of the rated motor current according to the name plate and the connection (Y / Δ). The factory setting depends on the unit size.

CP.14 DASM rated voltage

Co-domain	Setting	Description
120...830 V	see 3.4.5	Adjustment of the rated motor current according to the name plate and the connection (Y / Δ). The factory setting depends on the unit size.

CP.15 DASM cos(phi)

Co-domain	Setting	Description
0,50...1,00	see 3.4.5	Adjustment of the motor cos(phi) according to the name plate. The factory setting depends on the unit size.

Parameter Description

CP.16 DASM rated power

Co-domain	Setting	Description
0.35...1000 kW	see 3.4.5	Adjustment of the rated motor power according to the name plate. The factory setting depends on the unit size.

CP.17 Load mot. dependent para.

The basic settings of the inverter correspond to the unit size and the respective motor (see 3.4.5). If the motor data in CP.11...16 are changed, then CP.17 must be activated once. This re-adjusts the current controller, torque curve and torque limit. The torque limit is set at the value, that is maximally possible in the basic speed range (depending on inverter rated current). Rated motor torque x 3 at maximum.



Value	Setting	Description	Description
1	x	The voltage class of the inverter is taken as input voltage.	Pre-adjustment of the motor-dependent controller parameters.
2		The measured DC-link voltage divided by $\sqrt{2}$ measured at switch on is taken as input voltage. Thus the frequency inverter can be adapted to the actually available mains voltage (e.g. USA with 460 V).	
	When control release is active the adjustment was not completed. „nc0“ appears in the display.		

CP.18 Boost

Co-domain	Setting	Description
0,0...25,5%	LTK	In the lower speed range a large part of the motor voltage decreases on the stator resistance. So that the breakdown torque of the motor remains nearly constant in the controlled operation over the entire speed range, the voltage drop can be compensated by the Boost. During regulated operation (CP.10 = 4 or 5) this parameter has no function. Adjustment: <ul style="list-style-type: none"> Determine the rate of utilization in no-load operation with rated speed Preset about 300 rpm and adjust the boost, so that about the same rate of utilization is reached as with the rated speed.
	When the motor, during continuous operation, drives with low speed and too high voltage it can lead to an overheating of the motor.	

CP.19 Rated frequency

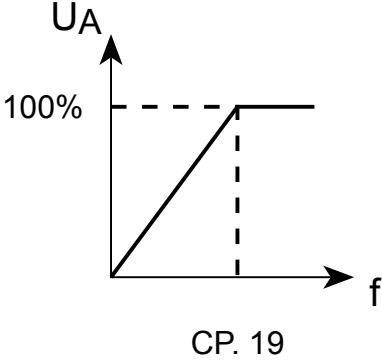
Co-domain	Setting	Description
0.00...400.00 Hz	50 Hz	With the adjusted frequency the inverter reaches in controlled operation a maximal output voltage. The adjustment of the rated motor frequency is typical in this case.
further on next side		

Co-domain	Setting	Description
		
		Motors can overheat when the rated frequency is incorrectly adjusted. During regulated operation (CP.10 = 4 or 5) this parameter has no function.

CP.20 Encoder 1 (inc/r)

Co-domain	Setting	Description
1...16383 inc	2500 inc	With this parameter the encoder line number is adjusted to the encoder that is connected to channel 1. Check the set and actual speed displays during controlled operation and compare. The correct settings must be actual speed = set speed - slip.
		The co-domain can vary due to different encoder identifiers.

CP.21 Encoder 1 rotation

Bit	Value	Function	Description
0		Encoder rotation	If you find that during start-up in open-loop operation the actual and setpoint speed have different signs it can be an indication for a wrong connection of the incremental encoder. If possible the wiring should be corrected. Should this involve too much effort then you can achieve a rotation reversal of encoder 1 by means of this parameter. The effect corresponds to a change of the A and B tracks of the incremental encoder. A system inverting can be adjusted with bit 4. With this it is possible to run the motor with positive setting counter-clockwise at the shaft.
	0	no modification (default)	
	1	inverted	
1	0	reserved	
2	0	reserved	
3	0	reserved	
4		system inverting	
	0	no modification (default)	
	16	inverted	

3.4.4 Special Adjustments

The following parameters serve for the optimization of the drive and the adaption to certain applications. These adjustments can be ignored at the initial start-up.

Parameter Description

CP.22 Maximum speed

Co-domain	Setting	Description
0...4000 rpm	2100 rpm	A maximum speed must be preset in order to limit the setpoint value. This limit value is the basis for further setpoint calculations and for the determination of setpoint characteristics. The maximum speed limits the setpoint speed only. Because of speed ripples, speed overshoot or hardware defects (e.g. defective encoder) the actual speed may exceed these limits.

CP.23 Fixed speed 1 (input 1)

CP.24 Fixed speed 2 (input 2)

	Co-domain	Setting	Description
CP.23	0...±4000 rpm	100 rpm	Two fixed speeds can be adjusted. The selection is made by the inputs I1 and I2. If adjustments are made that are outside the fixed limit of CP.22, then the speed is internally limited.
CP.24		-100 rpm	
	Input I1 + input I2 = fixed speed 3 (factory setting = 0 rpm) The step speed 3 cannot adjusted in the CP-mode.		

CP.25 Acc. time forward

Co-domain	Setting	Description
0.00...300.00 s	5.00 s	Defines the time needed to accelerate from 0 to 1000 rpm. The actual acceleration time is proportional to the speed change (Δn).
Δn Speed change Δt Acceleration time for Δn t		
Example		<p>The drive should accelerate from 300 rpm auf 800 rpm in 1 s.</p> <p>$\Delta n = 800 \text{ rpm} - 300 \text{ rpm} = 500 \text{ rpm}$</p> <p>$\Delta t = 1 \text{ s}$</p> $CP.25 = \frac{\Delta t}{\Delta n} \times 1000 \text{ rpm} = \frac{1 \text{ s}}{500 \text{ rpm}} \times 1000 \text{ rpm} = 2 \text{ s}$

Parameter Description

CP.26 Deceleration time

Co-domain	Setting	Description
-0.01...300.00 s	5.00 s	Defines the time needed to accelerate from 1000 to 0 rpm. The actual deceleration time is proportional to the speed change (Δn). At a deceleration time of -1 the value from CP.25 is used (Display „=Acc“)!
Δn Speed change Δt Deceleration time for Δn t		
	Example	<p>The drive should decelerate from 800 rpm to 300 rpm in 1 s.</p> <p>$\Delta n = 800 \text{ rpm} - 300 \text{ rpm} = 500 \text{ rpm}$</p> <p>$\Delta t = 1 \text{ s}$</p> <p>$\text{CP.26} = \frac{\Delta t}{\Delta n} \times 1000 \text{ rpm} = \frac{1 \text{ s}}{500 \text{ rpm}} \times 1000 \text{ rpm} = 2 \text{ s}$</p>

CP.27 S-curve time

Co-domain	Default	Description
0.00 (off)...5.00 s	0.00 s (off)	For some applications it is of advantage when the drive starts and stops jerk-free. This is achieved through a straightening of the acceleration and deceleration ramps. The straightening time, also called S-curve time, can be adjusted with CP.27.
t1 S-curve time (CP.27)		
t2 Acceleration time (CP.25) t3 Deceleration time (CP.26)		

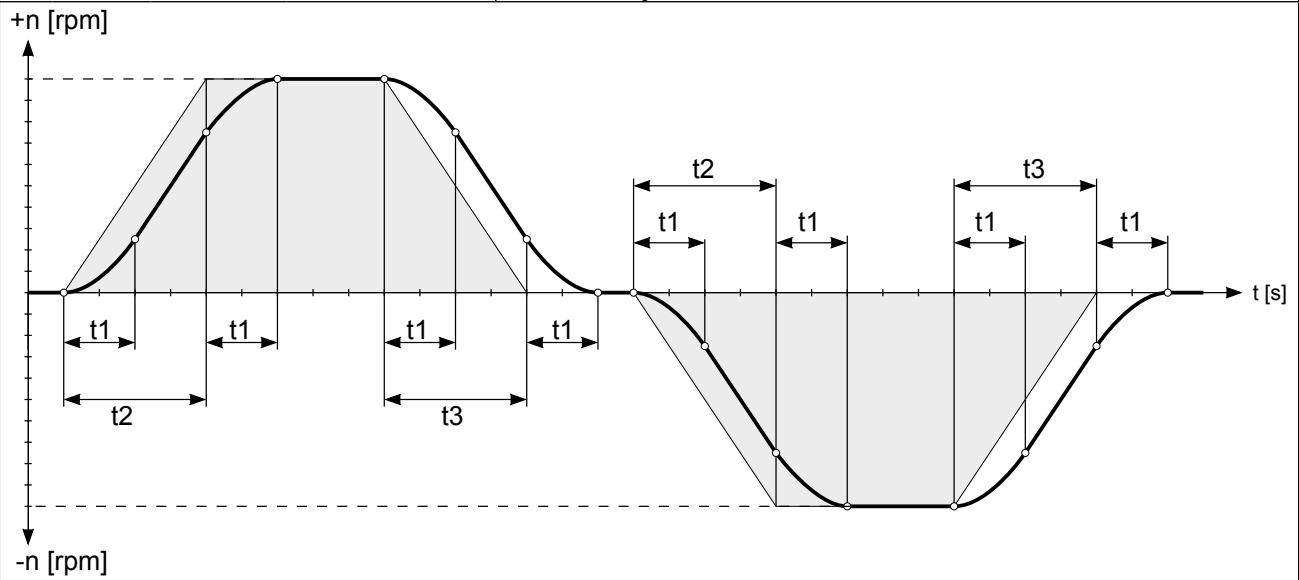

In order to drive defined ramps with activated S-curve time, the acceleration and deceleration times (CP.25 and CP.26) must be adjusted higher than the S-curve time (CP.27).

CP.28 Torque reference source

Value	Source	Setting range	Description
0	AN1+ / AN1-	0%...±100% = 0...±CP.29	With this parameter the required setpoint source for torque control can be adjusted.
1	AN2+ / AN2-	0%...±100% = 0...±CP.29	
2	digital absolute	CP.29	
3...5	Only application mode		

The values must be confirmed with „ENTER“.

CP.29 Absolute torque reference

Co-domain	Setting	Description
±10000.00 Nm	see 3.4.5	<p>The absolute torque reference of the drive is adjusted with parameter CP.29 in torque controlled operation (CP.10 = 5) and with digital setpoint setting (CP.28 = 2). The sign stands for direction of rotation to be active.</p> <p>In speed controlled operation (CP.10 = 4) the parameter works as torque limit in all quadrants. The sign has no effect at that.</p> <p>The factory setting depends on the adjusted motor data. During controlled operation (CP....10) this parameter has no function.</p>

Parameter Description

CP.30 KP speed

Co-domain	Setting	Description
0...32767	300	The proportional factor of the speed controller is adjusted in these parameters (see chapter 3.4.6 „Start-up“).

CP.31 KI speed

Co-domain	Setting	Description
0...32767	100	The integral factor of the speed controller is adjusted in these parameters (see chapter 3.4.6 „Start-up“).

CP.32 Switching frequency

Co-domain	Setting	Description
2 / 4 / 8 / 12 / 16 kHz	depend- ent of the power circuit	The switching frequency with which the power modules are clocked can be changed depending on the application. The maximum possible switching frequency and the factory setting is determined by the power circuit. The values must be confirmed with „ENTER“.

Refer to following list to learn about influences and effects of the switching frequency.

low switching frequency	high switching frequency
less inverter heating	less noise development
less discharge current	improved sine-wave simulation
less switching losses	less motor losses
less radio interferences	improved controller characteristics
improved concentricity with low speed (only open loop!)	



At switching frequencies above 4 kHz pay absolute attention to the max. motor line length in the technical data of the power circuit manual.

CP.33 Relay output 1 / function

CP.34 Relay output 2 / function

CP.33 and CP.34 determine the function of the two outputs. The values must be confirmed with „ENTER“.

Value	Function
0	No function (generally off)
1	Generally on
2	Run signal; also by DC braking
3	Ready signal (no error)
4	Fault relay
5	Fault relay (not at under voltage error)
6	Warning or error message at abnormal stopping
7	Overload alert signal
8	Overtemperature alert signal power modules
9	External overtemperature alert signal motor
10	Only application mode

further on next side

Value	Function
11	Overtemperature alert signal interior OHI
12...19	Only application mode
20	Actual value = set value (CP.03 = Fcon; rcon; not at noP, LS, error, SSF)
21	Accelerate (CP.03 = FAcc, rAcc, LAS)
22	Decelerate (CP.03 = FdEc, rdEc, LdS)
23	Real direction of rotation = set direction of rotation
24	Utilization > switching level ¹⁾
25	Active current > switching level ¹⁾
26	DC voltage > level ¹⁾
27	Real value (CP.01) > switching level ¹⁾
28	Setpoint (CP.02) > switching level ¹⁾
29...30	Only application mode
31	Absolute setpoint at AN1 > switching level ¹⁾
32	Absolute setpoint at AN2 > switching level ¹⁾
33	Only application mode
34	Set value at AN1 > switching level ¹⁾
35	Set value at AN2 > switching level ¹⁾
36...39	Only application mode
40	Hardware current limit activated
41	Modulation on-signal
42...46	Only application mode
47	Ramp output value > switching level ¹⁾
48	Apparent current (CP.04) > switching level ¹⁾
49	Forward running (not at nOP, LS, abnormal stopping or error)
50	Reverse running (not at nOP, LS, abnormal stopping or error)
51	Warning E.OL2
52	Current regulator limit reached
53	n-control limit active
54...62	Only application mode
63	Absolute value ANOUT1 > level ¹⁾
64	Absolute value ANOUT2 > level ¹⁾
65	ANOUT1 > switching level ¹⁾
66	ANOUT2 > switching level ¹⁾
67...69	Only application mode
70	driver VCC active (safety relay)
71...72	Only application mode
73	Absolut active power > switching level ¹⁾
74	Active power > switching level ¹⁾
75...79	Only application mode
80	Active current > switching level ¹⁾
81	Real value channel 1 > switching level ¹⁾
82	Real value channel 2 > switching level ¹⁾
83	Application mode
84...100	Only application mode

¹⁾ Switching level of CP.33 = 100; switching level of CP.34 = 4

Parameter Description

CP.35 Limit switch / stopping mode

This parameter determines the response of the drive to the terminal „F“ or „R“. These terminals are programmed as hardware limit switches. The reaction of the drive is shown in the table below.

Value	Setting	Display	Reaction	Restart
0		E.PR _x	Immediate disabling of modulation	Remove fault, reset
1		A.PR _x	Quick stopping / disabling of modulation after reaching speed 0	
2		A.PR _x	Quick stopping / holding torque at speed 0	
3		A.PR _x	Immediate disabling of modulation	Autoreset, if no fault is present
4		A.PR _x	Quick stopping / disabling of modulation after reaching speed 0	
5		A.PR _x	Quick stopping / holding torque at speed 0	
6	x	—	No effect to the drive, fault is ignored!	—

CP.36 Reaction to external fault

With the external error monitoring external units can take direct influence on the drive. This parameter determines the response of the drive to a signal at terminal „I3“, according to following table.

Value	Setting	Display	Reaction	Restart
0	x	E.PR _x	Immediate disabling of modulation	Remove fault, reset
1		A.PR _x	Quick stopping / disabling of modulation after reaching speed 0	
2		A.PR _x	Quick stopping / holding torque at speed 0	
3		A.PR _x	Immediate disabling of modulation	Autoreset, if no fault is present
4		A.PR _x	Quick stopping / disabling of modulation after reaching speed 0	
5		A.PR _x	Quick stopping / holding torque at speed 0	
6		—	No effect to the drive, fault is ignored!	—

3.4.5 Factory Settings

In the table below the factory settings for the size-dependent parameter values are listed.

Parameter	CP.11	CP.12	CP.13	CP.14	CP.15	CP.16	—	CP.29
Unit size/ Voltage class	Rated motor speed	Rated motor frequency	Rated motor current	Rated motor voltage	Rated motor cos(Phi)	Rated motor power	Rated motor torque	Maximum torque
	[rpm]	[Hz]	[A]	[V]	cos(Phi)	[kW]	[Nm]	[Nm]
09/200V	1400	50	5,9	230	0,83	1,5	10,23	22,09
10/200V	1420	50	9,0	230	0,78	2,2	14,79	30,68
12/200V	1435	50	15,2	230	0,79	4,0	26,61	53,53
13/200V	1440	50	18,2	230	0,89	5,5	36,47	69,92
14/200V	1450	50	26,0	230	0,84	7,5	49,39	93,40
15/200V	1450	50	37,5	230	0,85	11,0	72,43	137,48
16/200V	1465	50	50,0	230	0,86	15,0	97,76	190,64
17/200V	1460	50	60,5	230	0,86	18,5	120,99	248,74
18/200V	1465	50	72,5	230	0,84	22,0	143,38	296,04
19/200V	1465	50	96,0	230	0,85	30,0	195,52	345,92
20/200V	1470	50	115,0	230	0,86	37,0	240,33	446,60
21/200V	1470	50	140,0	230	0,86	45,0	292,29	554,43
22/200V	1480	50	210,0	230	0,86	55,0	354,83	541,18
23/200V	1480	50	240,0	230	0,87	75,0	483,85	698,88

Parameter Description

Parameter	CP.11	CP.12	CP.13	CP.14	CP.15	CP.16	—	CP.29
Unit size/ Voltage class	Rated motor speed	Rated motor frequency	Rated motor current	Rated motor voltage	Rated motor cos(Phi)	Rated motor power	Rated motor torque	Maximum torque
	[rpm]	[Hz]	[A]	[V]	cos(Phi)	[kW]	[Nm]	[Nm]
09/400V	1400	50	3,4	400	0,83	1,5	10,23	22,47
10/400V	1420	50	5,2	400	0,78	2,2	14,79	30,81
12/400V	1435	50	8,8	400	0,79	4,0	26,61	53,21
13/400V	1440	50	10,5	400	0,89	5,5	36,47	73,26
14/400V	1450	50	15,0	400	0,84	7,5	49,39	80,12
15/400V	1450	50	21,5	400	0,85	11,0	72,43	118,83
16/400V	1465	50	28,5	400	0,86	15,0	97,76	165,88
17/400V	1460	50	35,0	400	0,86	18,5	120,99	213,37
18/400V	1465	50	42,0	400	0,84	22,0	143,83	253,27
19/400V	1465	50	55,5	400	0,85	30,0	195,52	309,88
20/400V	1470	50	67,0	400	0,86	37,0	240,33	393,60
21/400V	1470	50	81,0	400	0,86	45,0	292,29	474,91
22/400V	1475	50	98,5	400	0,86	55,0	356,03	609,86
23/400V	1480	50	140,0	400	0,87	75,0	483,85	752,75
24/400V	1480	50	168,0	400	0,86	90,0	580,63	907,29
25/400V	1485	50	210,0	400	0,85	110,0	707,26	833,38
26/400V	1485	50	240,0	400	0,87	132,0	848,72	1.041,70
27/400V	1485	50	287,0	400	0,88	160,0	1028,75	1.264,01
28/400V	1485	50	370,0	400	0,88	200,0	1285,93	1.413,37
29/400V	1485	50	420,0	400	0,88	250,0	1607,42	1.780,29
30/400V	1490	50	535,0	400	0,88	315,0	2018,55	1.938,63
31/400V	1490	50	623,0	400	0,85	355,0	2274,87	2.566,84
32/400V	1490	50	710,0	400	0,84	400,0	2563,24	3.012,88
33/400V	1490	50	800,0	400	0,86	450,0	2880,00	3390,00
34/400V	1490	50	890,0	400	0,86	500,0	3200,00	3770,00
35/400V	1490	50	975,0	400	0,86	560,0	3590,00	4220,00
36/400V	1490	50	1060,0	400	0,86	630,0	4040,00	4750,00
37/400V	1490	50	1330,0	400	0,88	710,0	—	—
38/400V	1490	50	1450,0	400	0,88	800,0	—	—

Parameter	CP.11	CP.12	CP.13	CP.14	CP.15	CP.16	—	CP.29
Unit size/ Voltage class	Rated motor speed	Rated motor frequency	Rated motor current	Rated motor voltage	Rated motor cos(Phi)	Rated motor power	Rated motor torque	Maximum torque
	[rpm]	[Hz]	[A]	[V]	cos(Phi)	[kW]	[Nm]	[Nm]
28/600V	1485	50	230	690	0,88	0,20	—	—
29/600V	1485	50	280	690	0,88	0,25	—	—
30/600V	1490	50	350	690	0,88	0,32	—	—
31/600V	1490	50	390	690	0,88	0,36	—	—
32/600V	1490	50	440	690	0,88	0,40	—	—
33/600V	1490	50	500	690	0,88	0,45	—	—
34/600V	1490	50	550	690	0,88	0,50	—	—
35/600V	1490	50	620	690	0,88	0,56	—	—
36/600V	1490	50	710	690	0,88	0,63	—	—
37/600V	1490	50	820	690	0,88	0,71	—	—
38/600V	1490	50	900	690	0,88	0,80	—	—

3.4.6 Initial Start-up

For the initial start-up of KEB COMBIVERT F5-M do the following:

1. Open control release → frequency inverter in status „noP“
2. Select open loop operation → Parameter CP.10 = 0
3. Enter motor data → Parameter CP.11...CP.16
4. Activate load motor dependent parameter → Parameter CP.17 = 1 or 2
5. Enter necessary boost → Parameter CP.18
6. Enter encoder line number → Parameter CP.20
7. Observe cut-off frequency of encoder → see encoder specification
8. Startup in controlled operation → See the following flow chart

Parameter Description

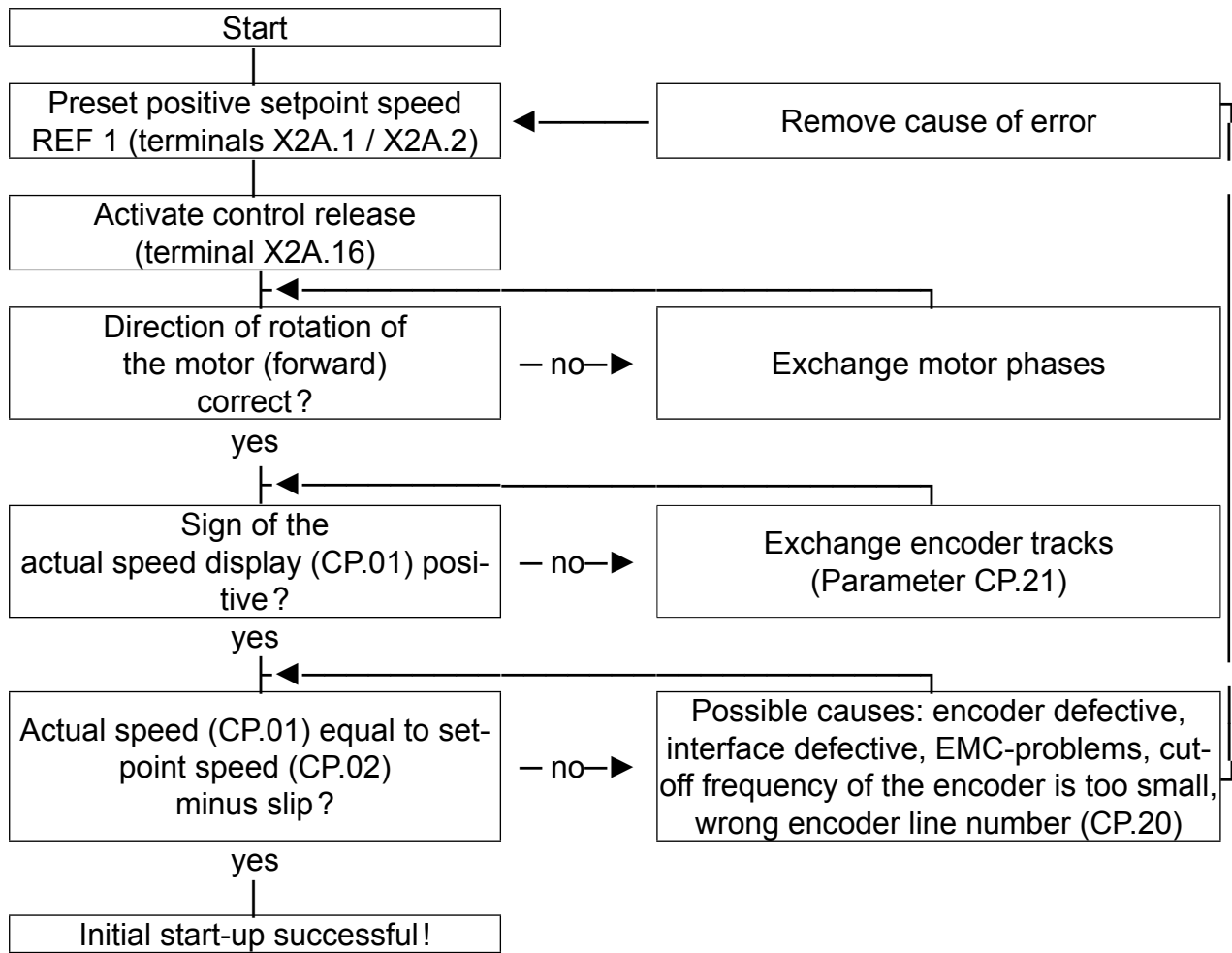

3.4.7 Adjustment speed controller

- | | |
|---------------------------------|---------------------------------------|
| 1. Open control release | => frequency inverter in status „noP“ |
| 2. Select closed loop operation | => Parameter CP.10 = 4 |

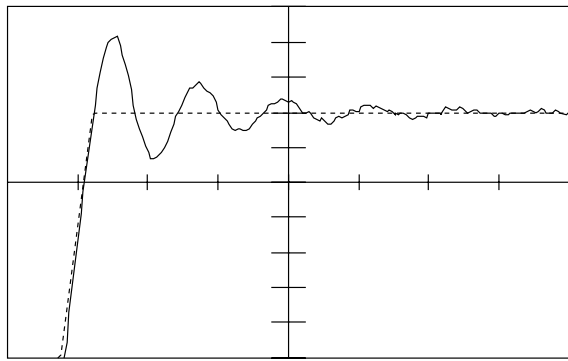
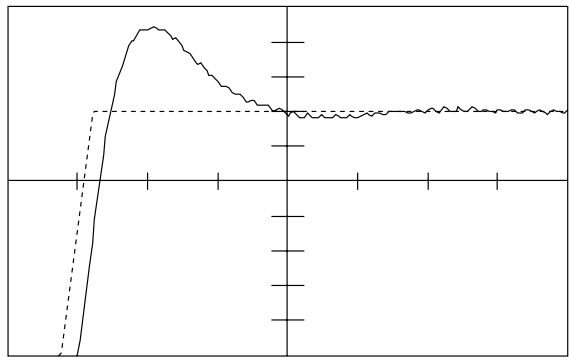
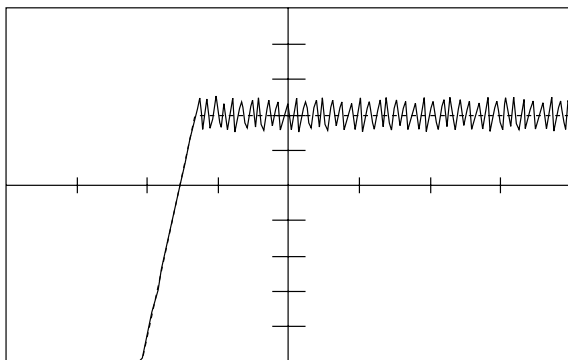
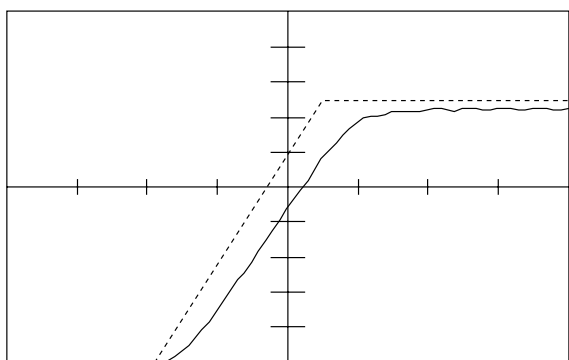
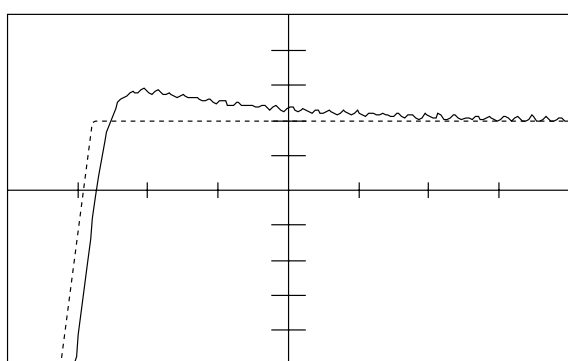
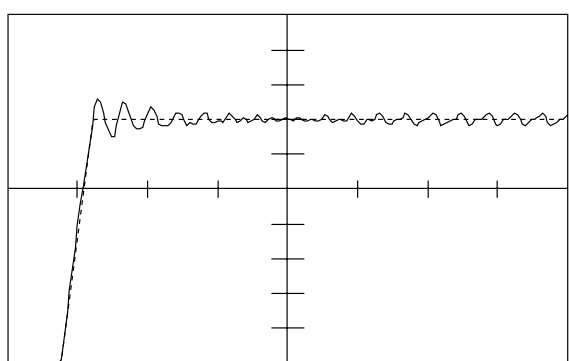
	
Problem Very long transient process	Problem Very long speed overshoot
Solution Increase KP speed (CP.30); eventually reduce KI speed (CP.31)	Solution Increase KP speed (CP.30); eventually reduce KI speed (CP.31)
	
Problem Sustained oscillation short billowy, noises, vibes	Problem Transient too slow / remaining system deviation
Solution Decrease KP speed (CP.30)	Solution Increase KI speed (CP.31)
	
Problem Overshoot too long, strong speed decreases at load change	Problem Sustained oscillation long billowy
Solution Increase KI speed (CP.31)	Solution Reduce KI speed (CP.31) and / or reduce KP speed (CP.30)

3.5 Factory setting for operating mode „SERVO“

Parameter	Setting range	Resolution	Default	Unit	E	based on
CP.00	password input	0...9999	1	-	-	ud.01
CP.01	encoder 1 speed	±4000	0,125	0	rpm	ru.09
CP.02	set value display	±4000	0,125	0	rpm	ru.01
CP.03	inverter state	0...255	1	0	-	ru.00
CP.04	apparent current	0...6553,5	0,1	0	A	ru.15
CP.05	peak apparent current	0...6553,5	0,1	0	A	ru.16
CP.06	actual torque	±32000,00	0,01	0	Nm	ru.12
CP.07	actual DC voltage	0...1500	1	0	V	ru.18
CP.08	peak DC voltage	0...1500	1	0	V	ru.19
CP.09	output voltage	0...1167	1	0	V	ru.20
CP.10	speed control configuration	4...6	1	4	-	cS.00
CP.11	DSM rated torque	0,1...6553,5	0,1	LTK	Nm	dr.27
CP.12	DSM rated speed	0...32000	1	LTK	rpm	dr.24
CP.13	DSM rated frequency	0,0...1600,0	0,1	LTK	Hz	dr.25
CP.14	DSM rated current	0,0...1500,0	0,1	LTK	A	dr.23
CP.15	DSM EMC voltage constant	0...32000	1	LTK	V	dr.26
CP.16	DSM motor winding inductance	0,01...500,00	0,01	LTK	mH	dr.31
CP.17	DSM motor winding resistance	0,000...250,00	0,001	LTK	Ω	dr.30
CP.18	DSM rated motor current	0,0...1490,0	0,1	LTK	A	dr.28
CP.19	load mot. dependent para.	0...3	1	0	-	E Fr.10
CP.20	absolute position enc.1	0...65535	1	57057	-	Ec.02
CP.21	encoder 1 rotation	0...19	1	0	-	Ec.06
CP.22	max. reference forward	0...4000	0,125	2100	rpm	oP.10
CP.23	step value 1	±4000	0,125	100	rpm	oP.21
CP.24	step value 2	±4000	0,125	-100	rpm	oP.22
CP.25	acc. time forward	0,00...300,00	0,01	5	s	oP.28
CP.26	dec. time forward -0.01=CP.25	-0,01...300,00	0,01	5	s	oP.30
CP.27	S-curve time	0,00...5,00	0,01	off	s	oP.32
CP.28	Torque reference source	0...6	1	2	-	E cS.15
CP.29	absolute torque reference	±32000,00	0,01	LTK	Nm	cS.19
CP.30	KP speed	0...32767	1	300	-	cS.06
CP.31	KI speed	0...32767	1	100	-	cS.09
CP.32	switching frequency	0...LTK	1	LTK	-	E uF.11
CP.33	relay output 1 / function	0...100	1	4	-	E do.02
CP.34	relay output 2 / function	0...100	1	2	-	E do.03
CP.35	Limit switch / stopping mode	0...6	1	6	-	Pn.07
CP.36	E.EF stopping mode	0...6	1	0	-	Pn.03

LTK=depending on power unit; E=ENTER parameter

	<p>Due to the calculation / measuring accuracies, tolerances with the current and torque displays as well as with the switching levels and limitations, must be taken into consideration. The given tolerances (see parameter description) refer to the respective maximum values with the dimensioning KEB COMBIVERT : Motor = 1 : 1.</p> <p>Dependent on the data from the motor manufacturer, larger tolerances at the torque displays are possible, due to the usual variations in the machine parameters and temperature drifts.</p>
--	---

3.5.1 Password input

CP.00 Password input

Ex works the frequency inverter is supplied without password protection, this means that all changeable parameters can be adjusted. After parameterizing the unit can be barred against unauthorized access (Passwords: see last but one page). The adjusted mode is stored.

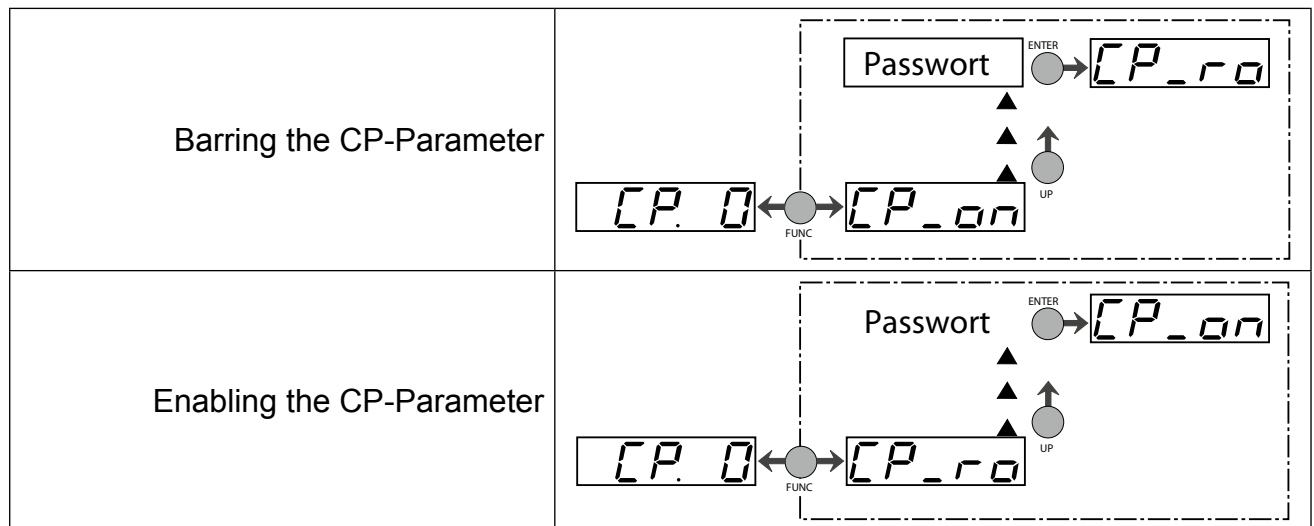

3.5.2 Operating Display

The parameters below serve for the controlling of the frequency inverter during operation.

CP.01 Encoder 1 speed

Co-domain	Description
0...±4000 rpm	Display of actual motor speed (incremental encoder 1). For control reasons the set speed is displayed, even if the control release or direction of rotation are not switched. A counter-clockwise rotating field (reverse) is represented by a negative sign. Precondition for the correct display value is the in-phase connection of the motor and the correct setting of the encoder line number (CP.20) as well as the direction of rotation (CP.21).

CP.02 Set value display

Co-domain	Description
0...±4000 rpm	Display of actually set value. For control reasons the set speed is displayed, even if the control release or direction of rotation are not switched. If no direction of rotation is set, the set speed for clockwise rotation (forward) is displayed.

CP.03 Inverter state

The status display shows the actual working conditions of the inverter. Possible displays and their meanings are:

nOP	„no Operation“ control release not bridged; modulation switched off; output voltage = 0V; drive is not controlled.
LS	„Low Speed“ no direction of rotation preset; modulation switched off; output voltage = 0V; drive is not controlled.
FAcc	"Forward Acceleration" drive accelerates with direction of rotation forward.
FdEc	„Forward Deceleration“ drive decelerates with forward direction.
rAcc	"Reverse Acceleration" drive accelerates with direction of rotation reverse.
rdEc	"Reverse Deceleration" drive decelerates with direction of rotation reverse.
Fcon	"Forward Constant" drive runs with a constant speed and direction of rotation forward.
rcon	"Reverse Constant" drive runs with constant speed and direction of rotation reverse.

Other status messages are described at the parameters, where they occur (see chapter 5 „Error diagnosis“).

CP.04 Apparent current

Co-domain	Description
0...±6553.5A	Display of the actual apparent current in ampere.

CP.05 Apparent current / peak value

Co-domain	Description
0...±6553.5A	CP.05 makes it possible to recognize the max. apparent current. For that the highest value of CP.04 is stored in CP.05. The peak value memory can be cleared by pressing the UP, DOWN or ENTER key or over bus by writing any value you like to the address of CP.05. The switch off of the inverter also clears the memory.

CP.06 Actual torque

Co-domain	Description
0.0...±10000A	The displayed value corresponds to the actual motor torque in Nm. The value is calculated from the active current. Because of normal type differences and temperature deviations of the motors, tolerances of up to 30 % are possible in the base speed range (see reference at 3.5). Requirement for the torque display is the adjustment of the motor data (CP.11...CP.16). If the real motor data deviate strongly from the data on the name plate the operating performance can be optimized by entering the real data. The adjustment of the name plate data is sufficient for a start-up.

CP.07 Actual DC voltage

Co-domain	Description												
0...1500V	Display of actual DC-link voltage in volt. Typical values: <table border="1" data-bbox="459 1211 1484 1386"> <thead> <tr> <th>V-class</th> <th>Normal operation</th> <th>Overtoltage (E.OP)</th> <th>Undervoltage (E.UP)</th> </tr> </thead> <tbody> <tr> <td>230V</td> <td>300...330V DC</td> <td>approx. 400V DC</td> <td>approx. 216V DC</td> </tr> <tr> <td>690V</td> <td>530...620V DC</td> <td>approx. 800V DC</td> <td>approx. 240V DC</td> </tr> </tbody> </table>	V-class	Normal operation	Overtoltage (E.OP)	Undervoltage (E.UP)	230V	300...330V DC	approx. 400V DC	approx. 216V DC	690V	530...620V DC	approx. 800V DC	approx. 240V DC
V-class	Normal operation	Overtoltage (E.OP)	Undervoltage (E.UP)										
230V	300...330V DC	approx. 400V DC	approx. 216V DC										
690V	530...620V DC	approx. 800V DC	approx. 240V DC										

CP.08 Peak DC voltage

Co-domain	Description
0...1500V	CP.08 makes it possible to recognize short-time voltage rises within an operating cycle. For that the highest value of CP.07 is stored in CP.08. The peak value memory can be cleared by pressing the UP, DOWN or ENTER key or over bus by writing any value you like to the address of CP.08. The switch off of the inverter also clears the memory.

CP.09 Output voltage

Co-domain	Description
0...1167V	Display of the actual output voltage in volt.

3.5.3 Basic adjustment of the drive

The following parameters determine the fundamental operating data of the drive and must be adjusted for the initial commissioning (see chapter 3.5.6 "Start-up"). They should be checked and/or adapted to the application.

CP.10 Speed control configuration

Value	Setting	Function	Description
0	x	off (open-loop operation)	With this parameter the basic setting of the speed controller is determined.
1		-reserved-	
2		-reserved-	
3		off (open-loop operation)	
4		Speed control(closed-loop operation)	
5		Torque control (closed-loop operation)	
6		Torque-/speed control (closed loop operation)	
7...127		off (open-loop operation)	

CP.11...CP.18 Motor data

Under these parameters the motor data can be read off and adjusted. If you have purchased the servo controller with motor from KEB, the optimal motor data are already adjusted and do not need to be changed anymore. The parameter data can be taken from the parameter overview of chapter 3.5.5.

CP.19 Load mot. dependent para.

The servo is factory adjusted according to the unit size to a special motor. If the motor data in CP.11...18 are changed, then CP.19 must be activated once. This re-adjusts the current controller, torque curve and torque limit. The torque limit is set at the value, that is maximally possible in the basic speed range (depending on inverter rated current). Rated motor torque x 3 at maximum.

Value	Setting	Description	Description
1	x	The voltage class of the inverter is taken as input voltage.	Pre-adjustment of the motor-dependent controller parameters.
2		The measured DC-link voltage divided by $\sqrt{2}$ measured at switch on is taken as input voltage. Thus the frequency inverter can be adapted to the actually available mains voltage (e.g. USA with 460 V).	
		When control release is active the adjustment was not completed. „nco“ appears in the display.	

CP.20 Absolute position enc.1

The system position of the attached resolver system is adjusted at EC.07. With this parameter it is possible to adjust the controller to a not aligned motor. An automatic trimming can be done if the system position of the motor is unknown. The direction of rotation must be checked before starting the trimming. The speed display at CP.01 must be positive when the

engine runs manual in clockwise direction. If this is not the case, the direction of rotation can be changed with CP.21. If the correct direction of rotation is displayed, it can be started with the adjustment.

- The connected motor must rotate free.
- Open control release (terminal „ST“)
- Enter CP.20 = 2206.
- Close control release (terminal „ST“)

Now the motor is excited with its rated current and aligned to its zero position. The adjustment is finished when the displayed system position at CP.20 does not change for approx. 5s. In this case open control release and switch off the unit.

If the error message E.EnC is displayed during trimming the direction of rotation must be checked (CP.21). In this case the position trimming must be repeated.

In case that motors with aligned encoder system are used, the value which has been established by the automatic trimming, can be entered under CP.20 as well. The trimming values of known motors of the COMBIVERT S4 series must be multiplied with the pole-pair number of the motor. The lower 16 bits of the result must be entered in CP.20.

Co-domain	Description
0...65535	The input value is a decimal value. The factory setting is 0.

Example 1:

6-pole motor (3 pole pairs) has a system position of 19.019 dec. with a S4-servo controller.

$$\begin{aligned}
 19019 \text{ dec} &= 4A4Bh \\
 4A4Bh \times 3 \text{ pole pairs} &= DEE1h \\
 DEE1h &= 57057 \text{ dec}
 \end{aligned}$$

The lower 16 bits of the hexadecimal result must be entered if the value exceeds 65535.

Example 2:

6-pole motor (3 pole pairs) has a system position of 23497 dec. with a S4-servo controller.

$$\begin{aligned}
 23497 \text{ dec} &= 5BC9h \\
 5BC9h \times 3 \text{ pole pairs} &= 1135Bh \\
 1135Bh &= 70491 \text{ dec} \\
 135Bh &= 4955 \text{ dec}
 \end{aligned}$$

CP.21 Encoder 1 rotation

Bit	Value	Function	Description
0		Encoder rotation	At manual rotation the actual speed at forward rotation has a positive sign and a negative at reverse rotation. In the other case a wrong connection of the incremental encoder can be the reason. If possible the wiring should be corrected. Should this involve too much effort then you can achieve a rotation reversal of encoder 1 by means of this parameter. The effect corresponds to a change of the A and B tracks of the incremental encoder. A system inverting can be adjusted with bit 4. With this it is possible to run the motor with positive setting counter-clockwise at the shaft.
	0	no modification (default)	
	1	inverted	
1	0	reserved	
2	0	reserved	
3	0	reserved	
4		system inverting	
	0	no modification (default)	
	16	inverted	

The bit values are to be added up and confirm by "ENTER".

3.5.4 Special Adjustments

The following parameters serve for the optimization of the drive and the adaption to certain applications. These adjustments can be ignored at the initial start-up.

CP.22 Maximum speed

Co-domain	Setting	Description
0...4000 rpm	2100 rpm	A maximum speed must be preset in order to limit the setpoint value. This limit value is the basis for further setpoint calculations and for the determination of setpoint characteristics. The maximum speed limits the setpoint speed only. Because of speed ripples, speed overshoot or hardware defects (e.g. defective encoder) the actual speed may exceed these limits.

CP.23 Fixed speed 1 (input 1)

CP.24 Fixed speed 2 (input 2)

	Co-domain	Setting	Description
CP.23	0...±4000 rpm	100 rpm	Two fixed speeds can be adjusted. The selection is made by the inputs I1 and I2. If adjustments are made that are outside the fixed limit of CP.22, then the speed is internally limited.
CP.24		-100 rpm	
	Input I1 + input I2 = fixed speed 3 (factory setting = 0 rpm) The step speed 3 cannot adjusted in the CP-mode.		

CP.25 Acc. time forward

Co-domain	Setting	Description
0.00...300.00 s	5.00 s	Defines the time needed to accelerate from 0 to 1000rpm. The actual acceleration time is proportional to the speed change (Δn).
Δn Speed change Δt Acceleration time for Δn t		
Example		<p>The drive should accelerate from 300 rpm auf 800rpm in 1s.</p> <p>$\Delta n = 800 \text{ rpm} - 300 \text{ rpm} = 500 \text{ rpm}$</p> <p>$\Delta t = 1 \text{ s}$</p> $CP.25 = \frac{\Delta t}{\Delta n} \times 1000 \text{ rpm} = \frac{1 \text{ s}}{500 \text{ rpm}} \times 1000 \text{ rpm} = 2 \text{ s}$

CP.26 Deceleration time

Co-domain	Setting	Description
-0.01...300.00 s	5.00 s	Defines the time needed to accelerate from 1000 to 0 rpm. The actual deceleration time is proportional to the speed change (Δn). At a deceleration time of -1 the value from CP.25 is used (Display „=Acc“)!
Δn Speed change Δt Deceleration time for Δn t		
	Example	<p>The drive should decelerate from 800 rpm to 300 rpm in 1 s.</p> <p>$\Delta n = 800 \text{ rpm} - 300 \text{ rpm} = 500 \text{ rpm}$</p> <p>$\Delta t = 1 \text{ s}$</p> $CP.26 = \frac{\Delta t}{\Delta n} \times 1000 \text{ rpm} = \frac{1 \text{ s}}{500 \text{ rpm}} \times 1000 \text{ rpm} = 2 \text{ s}$

CP.27 S-curve time

Co-domain	Setting	Description
0.00 (off)...5.00 s	0.00 s (off)	For some applications it is of advantage when the drive starts and stops jerk-free. This is achieved through a straightening of the acceleration and deceleration ramps. The straightening time, also called S-curve time, can be adjusted with CP.27.
t1	S-curve time (CP.27)	
t2	Acceleration time (CP.25)	
t3	Deceleration time (CP.26)	

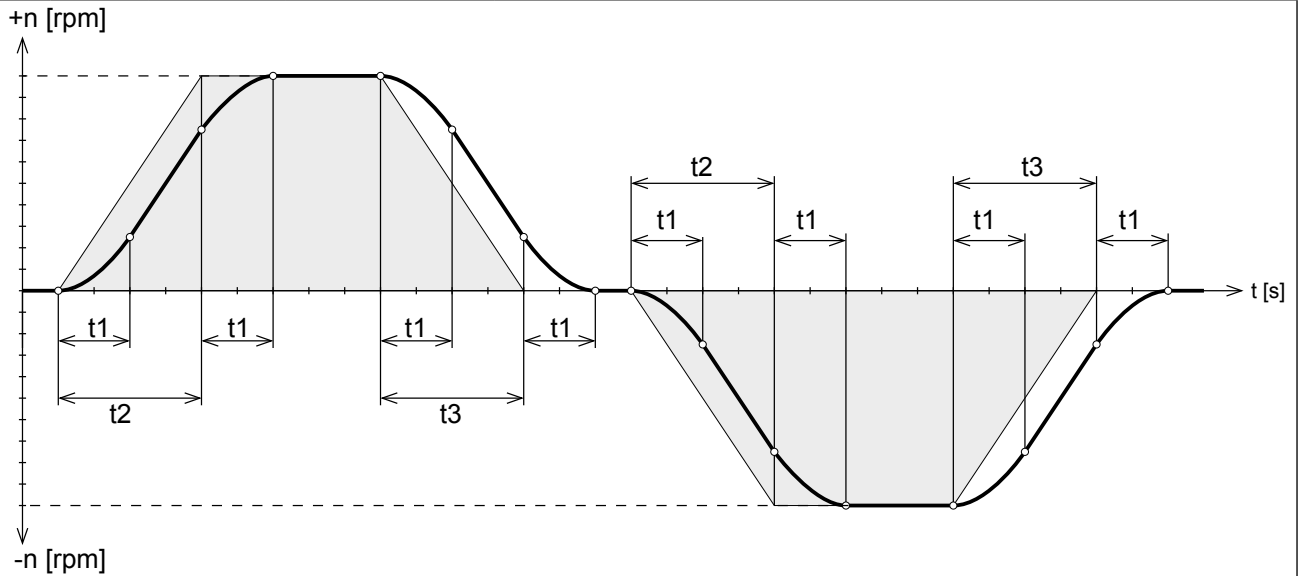

In order to drive defined ramps with activated S-curve time, the acceleration and deceleration times (CP.25 and CP.26) must be adjusted higher than the S-curve time (CP.27).

CP.28 Torque reference source

Value	Source	Setting range	Description
0	AN1+ / AN1-	0%...±100% = 0...±CP.29	With this parameter the required set-point source for torque control can be adjusted.
1	AN2+ / AN2-	0%...±100% = 0...±CP.29	
2	digital absolute	CP.29	
3...5	Only application mode		

The values must be confirmed with „ENTER“.

CP.29 Absolute torque reference

Co-domain	Setting	Description
±10000.00 Nm	see 4.4.5	The absolute torque reference of the drive is adjusted with parameter CP.29 in torque controlled operation (CP.10 = 5) and with digital setpoint setting (CP.28 = 2). The sign stands for direction of rotation to be active. In speed controlled operation (CP.10 = 4) the parameter works as torque limit in all quadrants. The sign has no effect at that. The factory setting depends on the adjusted motor data. During controlled operation (CP...10) this parameter has no function.
		Because of normal type differences and temperature deviations of the motors, tolerances of up to 30% are possible in the base speed range (see reference in chapter 3.5).

CP.30 KP speed

Co-domain	Setting	Description
0...32767	300	The proportional factor of the speed controller is adjusted in these parameters (see chapter 3.5.6 „Start-up“).

CP.31 KI speed

Co-domain	Setting	Description
0...32767	100	The integral factor of the speed controller is adjusted in these parameters (see chapter 3.5.6 „Start-up“).

CP.32 Switching frequency

Co-domain	Setting	Description
2 / 4 / 8 / 12 / 16 kHz	depend of the power circuit	The switching frequency with which the power modules are clocked can be changed depending on the application. The maximum possible switching frequency and the factory setting is determined by the power circuit. The values must be confirmed with „ENTER“.
Refer to following list to learn about influences and effects of the switching frequency.	low switching frequency	high switching frequency
	less inverter heating	less noise development
	less discharge current	improved sine-wave simulation
	less switching losses	less motor losses
	less radio interferences	improved controller characteristics
	improved concentricity with low speed (only open loop!)	
		At switching frequencies above 4 kHz pay absolute attention to the max. motor line length in the technical data of the power circuit manual.

CP.33 Relay output 1 / function**CP.34 Relay output 2 / function**

CP.33 and CP.34 determine the function of the two outputs. The values must be confirmed with „ENTER“.

Value	Function
0	off
1	on
2	Run signal; also by DC braking
3	No error
4	error message
5	Error without auto reset
6	Quick stopping / error
7	OL warning
8	OH warning
9	dOH warning
10	Only application mode
11	OHI warning
12...19	Only application mode
20	Actual value = set value (CP.03 = Fcon; rcon; not at noP, LS, error, SSF)
21	Accelerate (CP.03 = FAcc, rAcc, LAS)
22	Decelerate (CP.03 = FdEc, rdEc, LdS)
23	Real direction of rotation = set direction of rotation
24	act. utilization > level ¹⁾
25	Active current > switching level ¹⁾
26	DC voltage > level ¹⁾
27	Real value (CP.01) > switching level ¹⁾
28	Setpoint (CP.02) > switching level ¹⁾
29...30	Only application mode
31	Absolute setpoint at AN1 > switching level ¹⁾
32	Absolute setpoint at AN2 > switching level ¹⁾
33	Only application mode
34	Set value at AN1 > switching level ¹⁾
35	Set value at AN2 > switching level ¹⁾
36...39	Only application mode
40	Hardware current limit activated
41	modulation on
42...46	Only application mode
47	Ramp output value > switching level ¹⁾
48	Apparent current (CP.04) > switching level ¹⁾
49	C l o c k w i s e rotation
50	Counter-clockwise rotation
51	Warning E.OL2
52	Current regulator limit reached
	further on next side

CP-Parameter „Servo“

Value	Function
53	n-control limit active
54...62	Only application mode
63	Absolute value ANOUT1 > level ¹⁾
64	Absolute value ANOUT2 > level ¹⁾
65	ANOUT1 > switching level ¹⁾
66	ANOUT2 > switching level ¹⁾
67...69	Only application mode
70	driver VCC active (safety relay)
71...72	Only application mode
73	Absolut active power > switching level ¹⁾
74	Active power > switching level ¹⁾
75...79	Only application mode
80	Active current > switching level ¹⁾
81	Real value channel 1 > switching level ¹⁾
82	Real value channel 2 > switching level ¹⁾
83	Only application mode
84...100	Only application mode

¹⁾ Switching level of CP.33 = 100; switching level of CP.34 = 4

CP.35 Limit switch / stopping mode

This parameter determines the response of the drive to the terminal „F“ or „R“. These terminals are programmed as hardware limit switches. The reaction of the drive is shown in the table below.

Value	Setting	Display	Reaction	Restart
0		E.PRx	Immediate disabling of modulation	Remove fault, reset
1		A.PRx	Quick stopping / disabling of modulation after reaching speed 0	
2		A.PRx	Quick stopping / holding torque at speed 0	
3		A.PRx	Immediate disabling of modulation	Autoreset, if no fault is present
4		A.PRx	Quick stopping / disabling of modulation after reaching speed 0	
5		A.PRx	Quick stopping / holding torque at speed 0	
6	x	—	No effect to the drive, fault is ignored!	—

CP.36 Reaction to external fault

With the external error monitoring external units can take direct influence on the drive. This parameter determines the response of the drive to a signal at terminal „I3“, according to following table.

Value	Setting	Display	Reaction	Restart
0	x	E.PRx	Immediate disabling of modulation	Remove fault, reset
1		A.PRx	Quick stopping / disabling of modulation after reaching speed 0	
2		A.PRx	Quick stopping / holding torque at speed 0	
3		A.PRx	Immediate disabling of modulation	Autoreset, if no fault is present
4		A.PRx	Quick stopping / disabling of modulation after reaching speed 0	
5		A.PRx	Quick stopping / holding torque at speed 0	
6		—	No effect to the drive, fault is ignored!	—

3.5.5 Motor data (factory setting)

The following table contains the motor data of standard motors.

Parameter		CP.11	CP.12	CP.13	CP.14	CP.15	CP.16	CP.17	CP.18	CP.29
Unit size/ Voltage class	Default motor	Rated motor torque	Rated motor speed	Rated motor frequency	Rated motor current	DSM EMK voltage constant	Winding inductance	Winding resistance	Stand still current	Maximum torque
		[Nm]	[rpm]	[Hz]	[A]	[V/1000rpm]	mH	Ω	[A]	[Nm]
05/200V	A1.SM.000-6200	2,58	6000	300	1,0	28	9,9	21,0	1,2	5,93
07/200V	C1.SM.000-6200	5,12	6000	300	2,4	26	7,6	5,1	3,0	10,94
09/200V	C3.SM.000-3200	3,9	3000	150	4,2	69	6,9	2,0	5,1	22,09
10/200V	C4.SM.000-3200	5	3000	150	5,7	68	4,5	1,2	7,1	30,68
12/200V	D2.SM.000-3200	6,1	3000	150	8,1	67	4	1	8,5	53,53
13/200V	D3.SM.000-3200	8,4	3000	150	10,9	69	2,8	0,6	12,4	69,92
14/200V	E4.SM.000-3200	15,5	3000	150	16	89	1,3	0,29	27,8	93,40
05/400V	A1.SM.000-6400	2,58	6000	300	0,8	39	18,7	40,5	0,9	5,78
07/400V	C1.SM.000-6400	5,12	6000	300	1,3	48	25,9	18,9	1,6	12,29
09/400V	C3.SM.000-3400	3,9	3000	150	2,4	118	20,6	5,9	2,9	22,47
10/400V	C4.SM.000-3400	5	3000	150	3,4	113	13,1	3,4	4,2	30,81
12/400V	D2.SM.000-3400	6,1	3000	150	4,5	119	12,8	3,2	4,8	53,21
13/400V	D4.SM.000.3400	9,9	3000	150	7,3	121	1,5	1,4	8,5	73,26
14/400V	E2.SM.000-3400	11	3000	150	7	136	8,2	2	9	80,12
15/400V	E4.SM.000-3400	15,5	3000	150	9,9	143	3,4	0,81	17,3	118,83

further on next side

Parameter		CP.11	CP.12	CP.13	CP.14	CP.15	CP.16	CP.17	CP.18	CP.29
Unit size/ Voltage class	Default motor	Rated motor torque	Rated motor speed	Rated motor frequency	Rated motor current	DSM EMK voltage constant	Winding inductance	Winding resistance	Stand still current	Maximum torque
		[Nm]	[rpm]	[Hz]	[A]	[V/1000rpm]	mH	Ω	[A]	[Nm]
16/400V	F1.SM.000-3400	20	1465	150	13,8	130	7	0,58	17	165,99
17/400V	F2.SM.000-3400	31	3000	150	20,6	135	3,6	0,23	32,2	213,37
18/400V	F3.SM.000-3400	33	3000	150	22,9	131	1,7	0,13	46,2	253,27

3.5.6 Initial Start-up

The speed controller must be adjusted when the KEB COMBIVERT F5-SERVO is taken into operation. By using the software COMBIVIS a setvalue jump can be recorded. With the examples on the following page the speed controller can be adjusted.

- Install and program COMBIVIS on the PC. Select and start program SCOPE.
- Parameterize SCOPE:
 Operating mode: Offline
 Time pattern: 2ms
 Trigger position: 5%
 Trigger condition: Fixed speed input (I1 or I2)
 Channel A: ru.01 Set speed Channel B: ru.07 Actual speed
- Go into operating mode SCOPE, calibrate channels and adjust the time base (e.g. 50ms/DIV).
- Activate control release (ST)
- Preset fixed speed CP.23 or CP.24 (e.g. half rated speed)
- Activate fixed speed via I1 or I2. The KEB COMBIVERT executes a setpoint step change.
- Then read out the data with SCOPE and compare the recorded speed jump with the examples on the next page and adjust the speed controller accordingly.
- Repeat speed jump and record again until a clean transient process is found and thus an optimal control setting.
- Rough adjustment of the speed controller without using the SCOPE: Increase P-part to the stability limit (system begins to oscillate) and then reduce about 30%.
- Repeat the same procedure with the I-part.

3.5.7 Adjustment speed controller

With the PC software KEB COMBIVIS (Scope) setpoint and real speed can be displayed. If one of the following real speed curves occurs at acceleration, the speed controller (CP.30, CP.31) should be adjusted according to the notes.

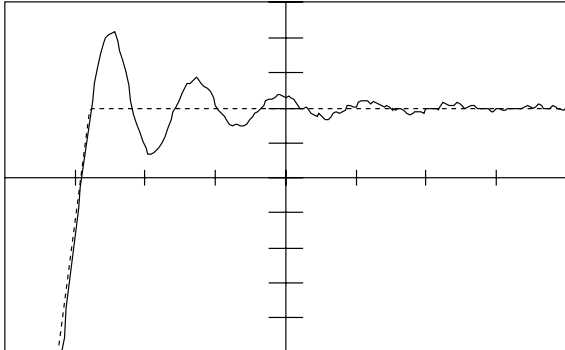
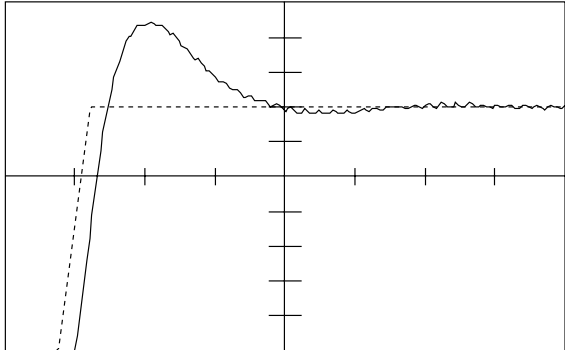
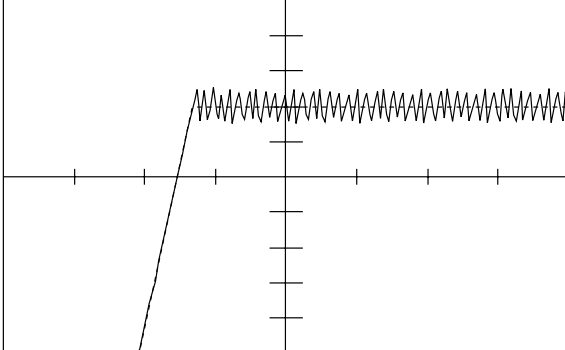
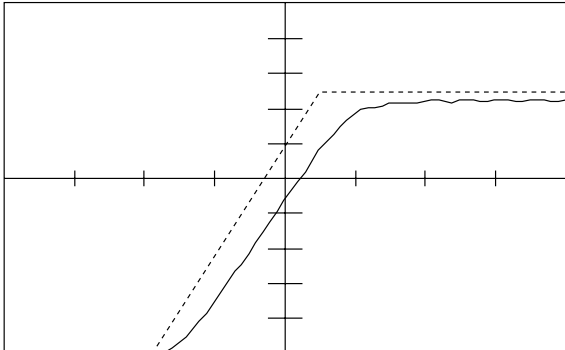
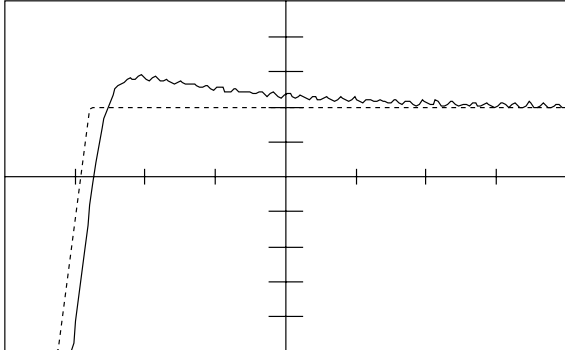
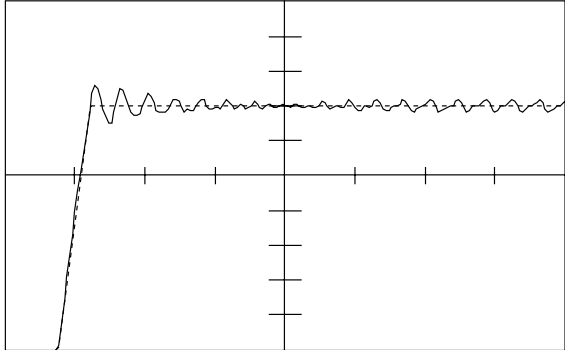
			
Problem	Very long transient process	Problem	Very long speed overshoot
Solution	Increase KP speed (CP.30); eventually reduce KI speed (CP.31)	Solution	Increase KP speed (CP.30); eventually reduce KI speed (CP.31)
			
Problem	Sustained oscillation short billowy, noises, vibes	Problem	Transient too slow / remaining system deviation
Solution	Decrease KP speed (CP.30)	Solution	Increase KI speed (CP.31)
			
Problem	Overshoot too long, strong speed decreases at load change	Problem	Sustained oscillation long billowy
Solution	Increase KI speed (CP.31)	Solution	Reduce KI speed (CP.31) and / or reduce KP speed (CP.30)

4. Drive Mode

The Drive Mode is an operating mode of KEB COMBIVERT that permits the manual starting of the drive by the operator. After switching the control release the set value and rotation setting occurs only via keyboard. In order to activate the drive mode the corresponding **password** (see last but one page) must be entered **in CP. 00**. The display switches over as follows:

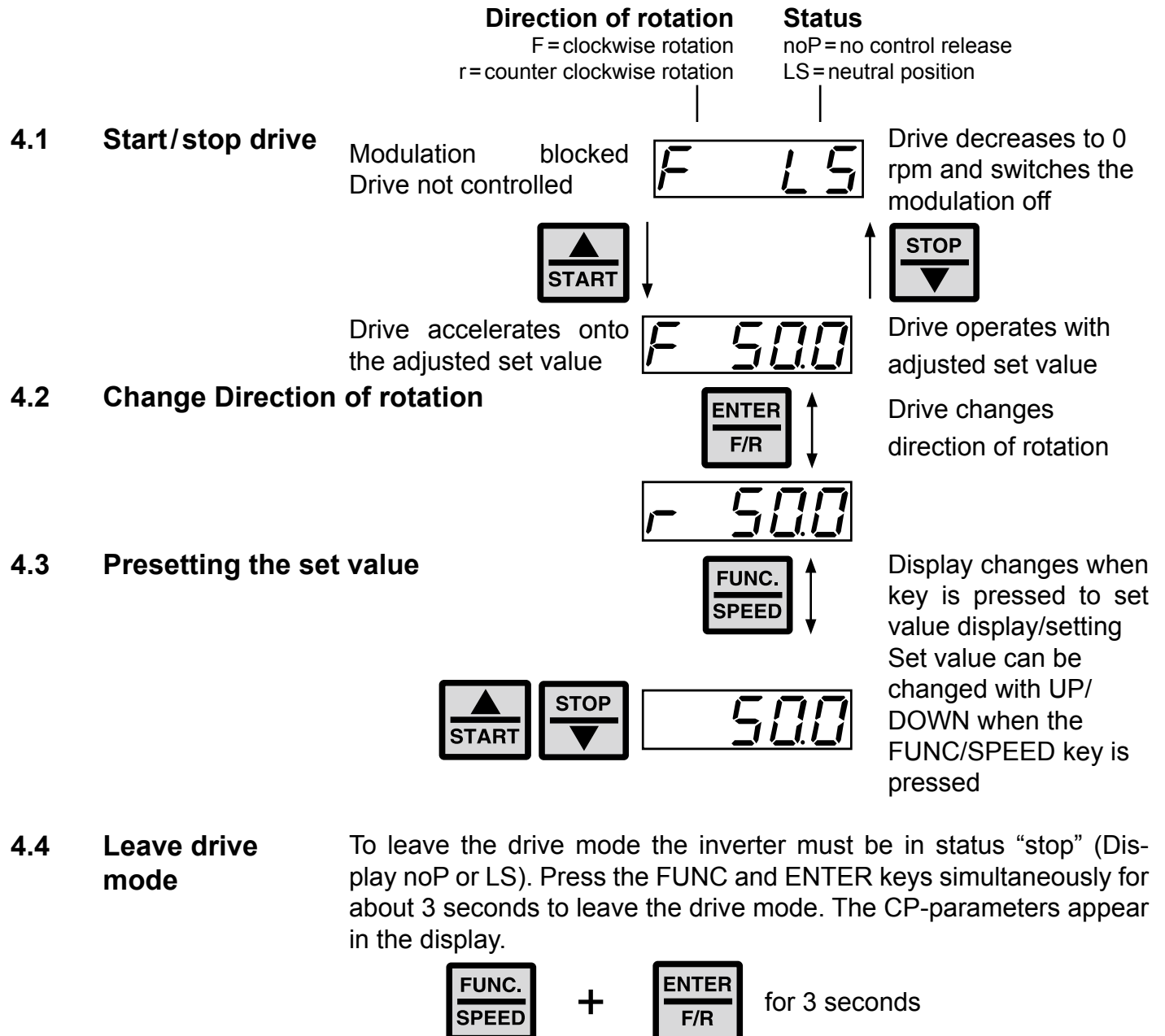

5. Error Assistance

Error messages at KEB COMBIVERT are always displayed with "E." and the appropriate error code in the display. Error messages cause the immediate deactivation of the modulation. Restart possible only after reset or autoreset.

Malfunction are represented with an „A.“ and the appropriate message. Reactions to malfunctions can vary. In the following the display and their cause are described.

Display	COMBIVIS	Value	Meaning
Status Messages			
bAC	blockade recognized	129	The setpoint must be above level Pn.86. If the actual value is below the level, the counter starts. If the counter reaches the adjusted time in Pn.86, a blockade is recognized. Output function do.00...do.07 = 96 (blockade active) is set. On exceeding the limit the value of the counter decreases.
bbL	base block	76	Power modules for motor de-excitation locked
bon	close brake	85	brake
boFF	open brake	86	Brake control
brA	Blockade resettable	130	The warning message blockade is no longer available. The message can be reset. Output function do.00...do.07 = 97 "blockade resettable" is set.
Cdd	calculate drive data	82	Measurement of the motor stator resistance.
Cddr	calc. drive data ready	127	Calculation drive data ready
dcb	DC brake	75	Motor is decelerated by a DC voltage at the output.
dLS	low speed / DC brake	77	Modulation is switched off after DC-braking
FAcc	forward acceleration	64	Acceleration with the adjusted ramps in forward direction of rotation.
Fcon	forward constant	66	Acceleration / deceleration phase is completed and it is driven with constant speed / frequency in forward direction of rotation.
FdEc	forward deceleration	65	Deceleration with the adjusted ramp times in forward direction of rotation.
HCL	hardware current limit	80	The message is output if the output current reaches the hardware current limit.
IPnA	pos.not accessib.ignored	126	Position not accessible ignored
LAS	LA stop	72	This message is displayed if during acceleration the load is limited to the adjusted load level.
LdS	Ld stop	73	This message is displayed if during deceleration the load is limited to the adjusted load level or the DC link current to the adjusted voltage level.
LS	low speed	70	No direction of rotation preset, modulation switched off.
nO_PU	power unit not ready	13	Power circuit not ready or not identified by the control.
nOP	no operation	0	Control release (terminal ST) is not switched.
PA	positioning active	122	This message is displayed during a positioning process.
PLS	low speed / power off	84	No modulation after Power-Off.

Error Assistance

Display	COMBIVIS	Value	Meaning
PnA	positioning not accessible	123	The specified position cannot be reached within the preset ramps. The abort of the positioning can be programmed.
POFF	power off	78	Depending on the programming of the function the inverter restarts automatically upon system recovery or after a reset.
POSI	positioning	83	Positioning function active (F5-G).
PrF	prot. rot. for.	124	closed direction of rotation forward
Prr	prot. rot. rev.	125	closed direction of rotation reverse
rAcc	reverse acceleration	67	Acceleration with the adjusted ramp times in reverse direction of rotation.
rcon	reverse constant	69	Acceleration / deceleration phase is completed and it is driven with constant speed / frequency in forward direction of rotation.
rdEc	reverse deceleration	68	It is stopped with the adjusted ramp times in reverse direction of rotation.
rFP	ready for positioning	121	The drive signals that it is ready to start the positioning process.
SLL	stall	71	This message is displayed if during constant operation the load is limited to the adjusted current limit.
SrA	search for ref. active	81	Search for reference point approach active.
SrF	reference found	128	Reference point found (only special version)
SSF	speed search	74	Speed search function active, that means that the inverter attempts to synchronize onto a running down motor.
STO	ERROR safety	28	Error in a function (monitored by the optional safety module). See safety manual 00F5N1S-K000 Error "Error 28: safety function" can not be reset with a digital input. The error can only be reset when the frequency inverter is switched off and on.
STOP	quick stop	79	The message is output if as response to a warning signal the quick-stop function becomes active.
Error Messages			
E.Acc	ERRORmaximum acceleration	24	Maximum acceleration exceeded
E. br	ERRORbrake	56	Error: can occur in the case of switched on brake control, if the load is below the minimum load level (Pn.43) at start up or the absence of an engine phase was detected the load is too high and the hardware current limit is reached

further on next side

Display	COMBIVIS	Value	Meaning
E.buS	ERRORWatchdog	18	Adjusted monitoring time (Watchdog) of communication between operator and PC / operator and inverter has been exceeded.
E.Cdd	ERRORcalc. drive data	60	Error: During the automatic motor stator resistance measurement.
E.dOH	ERRORdrive overheat	9	Error: Overtemperature of motor PTC. Error can only be reset at E.ndOH, if PTC is again low-resistance. Causes:
			resistance at the terminals T1/T2 >1650 Ohm
			motor overloaded
			line breakage to the temperature sensor
			load-shunt overheated.
			 Error E.dOH should be avoided in any case, since the load-shunt is no longer evaluated. This can cause damage to the hardware!
E.dri	ERRORdriver relay	51	Error: Driver relay. Relay for driver voltage on power circuit has not picked up even though control release was given.
E.EEP	ERROREEPROM defective	21	After reset operation is possible again (without storage in the EEPROM)
E. EF	ERRORexternal fault	31	Error: External error. Is triggered, if a digital input is being programmed as external error input and trips.
E.Enc1	ERROREncoder 1	32	Cable breakage of the encoder. Encoder temperature is too high. Speed is too high. Encoder signals are out of specification. Internal defect.
E.EnC2	ERRORencoder 2	34	
E.Hyb	ERROREncoder interface	52	Invalid encoder interface identifier
E.HybC	ERRORhybrid changed	59	Error: Encoder interface identifier has changed, it must be confirmed via ec.0 or ec.10.
E.iEd	ERRORInput identification	53	Hardware error at NPN-/PNP change-over
E.iPH	ERROROutput phase	6	Phase loss detection at the output
E.InI	ERRORinitialisation MFC	57	MFC not booted
E.LSF	ERRORload shunt fault	15	Load-shunt relay has not picked up. occurs for a short time during the switch-on phase, but must automatically be reset immediately. If the error message remains the following causes may be applicable:
			load-shunt defective
			input voltage wrong or too low
			high losses in the supply cable
			braking resistor wrongly connected or damaged
			braking module defective
			further on next side

Error Assistance

Display	COMBIVIS	Value	Meaning
E.ndOH	no ERROR drive over-heat	11	Motor temperature switch or PTC at the terminals T1/T2 is again in the normal operating range. The error can be reset now.
E.nOH	no E. overheat pow.mod.	36	Temperature of the heat sink is again in the permissible operating range. The error can be reset now.
E.nOHI	no ERROR overheat int.	7	No longer overheating in the interior E.OHI, interior temperature has fallen by at least 3°C
E.nOL	no ERROR overload	17	No more overload, OL-counter has reached 0%; after the error E.OL a cooling down phase must elapse. This message appears upon completion of the cooling down phase. The error can be reset now. The inverter must remain switched on during the cooling down phase.
E.nOL2	no ERROR overload 2	20	The cooling time has elapsed. The error can be reset.
E.OC	ERROR overcurrent	4	Occurs, if the specified peak current is exceeded. Causes:
			acceleration ramps too short
			the load is too big at turned off acceleration stop and turned off constant current limit
			short-circuit at the output
			short-circuit at the output
			deceleration ramp too short
			motor cable too long
			EMC
E.OH	ERROR overheat pow. mod.	8	Error: Overtemperature of power module. Error can only be reset at E.nOH Causes:
			insufficient air flow at the heat sink (soiled)
			ambient temperature too high
			ventilator clogged
E.OH2	ERROR motor protect.	30	Electronic motor protective relay has tripped.
E.OHI	ERROR overheat int.	6	Error: Overheating in the interior: error can only be reset at E.nOHI, if the interior temperature has dropped by at least 3 °C.
E.OL	ERROR overload (lxt)	16	Error: Overload error can only be reset at E.nOL, if OL-counter reaches 0% again. Occurs, if the overload is longer than the permissible time (see technical data). Causes:
			poor control adjustment (overshooting)
			mechanical fault or overload in the application
			inverter not correctly dimensioned
			motor wrongly wired motor wrongly wired
encoder damaged			

further on next side

Display	COMBIVIS	Value	Meaning
E.OL2	ERROR overload 2	19	Occurs if the standstill constant current is exceeded (see technical data in the power circuit manual). The error can only be reset if the cooling time has elapsed and E.nOL2 is displayed.
E.OP	ERROR overpotential	1	Voltage in the DC-link circuit too high. Occurs when the DC bus voltage rises above the permissible value. Causes:
			poor controller adjustment (overshooting)
			input voltage too high
			interference voltages at the input
			deceleration ramp too short
E.OS	ERROR overspeed	58	Real speed is bigger than the max. output speed. (can also occur when exceeding the absolute speed referring to EMC = EMC not correct (servo drives).)
E.PrF	ERROR prot. rot. for.	46	The drive has driven onto the right limit switch. Programmed response „Error, restart after reset“.
E.Prr	ERROR prot. rot. rev.	47	The drive has driven onto the left limit switch. Programmed response „Error, restart after reset“.
E. Pu	ERROR power unit	12	Error: General power circuit fault
E.Puci	ERROR pow. code inv.	49	Error: During the initialization the power circuit could not be recognized or was identified as invalid.
E.Puch	ERROR power unit changed	50	Error: Power circuit identification was changed; with a valid power circuit this error can be reset by writing to SY.03. If the value displayed in SY.03 is written, only the power-circuit dependent parameters are reinitialized. If any other value is written, then the default set is loaded. On some systems after writing Sy.03 a Power-On-Reset is necessary.
E.SbuS	ERROR bus synchron	23	Synchronization over sercos-bus not possible. Programmed response „Error, restart after reset“.
E.SCL	ERROR speed controller limit	25	Speed controller limit reached
E.SET	ERROR set	39	It has been attempted to select a locked parameter set. Programmed response „Error, restart after reset“.
E.SLF	ERROR limit switch right	44	The target position lies outside of the limit defined with the right software limit switch. Programmed response „Error, restart after reset“.
E.SLr	ERROR limit switch left	45	The target position lies outside of the limit defined with the left software limit switch. Programmed response „Error, restart after reset“.
			further on next side

Error Assistance

Display	COMBIVIS	Value	Meaning
E.UP	ERROR underpotential	2	Error: Undervoltage (DC-link circuit) Occurs, if DC-link voltage falls below the permissible value. Causes:
			input voltage too low or instable
			inverter rating too small
			voltage losses through wrong cabling
			the supply voltage through generator / transformer breaks down at very short ramps
			at F5-G housing B E.UP is also displayed if no communication takes place between power circuit and control card.
			jump factor (Pn.56) too small
E.UPh	ERROR Phase loss	3	One phase of the input voltage is missing (ripple-detection)
Warning Messages			
A.Acc	ABN.STOP maximum acceleration	106	Maximum acceleration exceeded
A.buS	ABN.STOP ABN.STOP bus	93	Warning: Watchdog for communication between operator/control card or operator/PC has responded. The response to this warning can be programmed.
A.dOH	ABN.STOP drive over-heat	96	The motor temperature has exceeded an adjustable warning level. The switch off time is started. The response to this warning can be programmed. This warning can be generated only with a special power circuit.
A. EF	ABN.STOP external fault	90	This warning is triggered via an external input. The response to this warning can be programmed.
A.ndOH	no ABN.STOPdrive over-heat	91	The motor temperature is again below the adjusted warning level. The switch off time is stopped.
A.nOH	no ABN.STOPoverheat pow.mod.	88	The heat sink temperature is again below the adjusted warning level.
A.nOHI	no ABN.STOPoverheat int.	92	The temperature in the interior of the inverter is again below the warning threshold.
A.nOL	no ABN.STOPOverload	98	Warning: no more overload, OL counter has reached 0 %, warning „overload" can be reset.
A.nOL2	no ABN.STOPOverload 2	101	The cooling time after "Warning! Overload during standstill" has elapsed. The warning message can be reset.

further on next side

Display	COMBIVIS	Value	Meaning
A. OH	ABN.STOP overheat pow. mod.	89	A level can be defined, when it is exceeded this warning is output. The response to this warning can be programmed.
A.OH2	ABN.STOP motor protect.	97	Warning: electronic motor protective relay has tripped. The response to this warning can be programmed.
A.OHI	ABN.STOP overheat int.	87	The temperature in the interior of the inverter lies above the permissible level. The switch off time was started. The programmed response to this warning message is executed.
A. OL	ABN.STOP overload (lxt)	99	A level between 0 and 100 % of the load counter can be adjusted, when it is exceeded this warning is output. The response to this warning can be programmed.
A.OL2	ABN.STOP overload 2	100	The warning is output when the standstill continuous current is exceeded (see technical data and overload characteristics). The response to this warning can be programmed. The warning message can only be reset after the cooling time has elapsed and A.nOL2 is displayed.
A.PrF	ABN.STOP prot. rot. for.	94	The drive has driven onto the right limit switch. The response to this warning can be programmed.
A.Prr	ABN.STOP prot. rot. rev.	95	The drive has driven onto the left limit switch. The response to this warning can be programmed.
A.SbuS	ABN.STOP bus synchron	103	Synchronization over sercos-bus not possible. The response to this warning can be programmed.
A.SCL	ABN.STOP speed controller limit	107	Speed controller limit reached
A.SET	ABN.STOP set	102	It has been attempted to select a locked parameter set. The response to this warning can be programmed.
A.SLF	ABN.STOP soft.limit for.	104	The target position lies outside of the limit defined with the right software limit switch. The response to this warning can be programmed.
A.SLr	ABN.STOP ABN.STOP soft.limit rev.	105	The target position lies outside of the limit defined with the right software limit switch. The response to this warning can be programmed.

Parameter Description

6. Quick Guide

6.1 Quick guide for operating mode „GENERAL“

Parameter	Setting range	Resolution	Unit	E	Customer setting
CP.00	password input	0...9999	1	-	-
CP.01	actual frequency display	-400...400	0,0125	Hz	-
CP.02	set frequency display	-400...400	0,0125	Hz	-
CP.03	inverter state	0...255	1	-	-
CP.04	apparent current	0...6553,5	0,1	A	-
CP.05	Apparent current / peak value	0...6553,5	0,1	A	-
CP.06	utilization	0...65535	1	%	-
CP.07	actual DC voltage	0...1500 B/C: 0...1000	1	V	-
CP.08	peak DC voltage	0...1500 B/C: 0...1000	1	V	-
CP.09	output voltage	0...1167 B/C: 0...778	1	V	-
CP.10	min. frequency	0...400	0,0125	Hz	-
CP.11	max. frequency forward	0...400	0,0125	Hz	-
CP.12	acc. time forward	0,00...300,00	0,01	s	-
CP.13	dec. time forward (-0.01 = CP.12)	-0,01...300,00	0,01	s	-
CP.14	S-curve time	0,00...5,00	0,01	s	-
CP.15	boost	0,0...25,5	0,1	%	-
CP.16	rated frequency	0...400	0,0125	Hz	-
CP.17	voltage stabilisation	1...1120 B/C: 1...650(off)	1	V	E
CP.18	switching frequency	2/4/8/12/16	1	kHz	E
CP.19	step value 1	-400...400	0,0125	Hz	-
CP.20	step value 2	-400...400	0,0125	Hz	-
CP.21	step value 3	-400...400	0,0125	Hz	-
CP.22	DC braking mode	0...506 B/C: 0...9	1	-	E
CP.23	DC braking time	0,00...100,00	0,01	s	-
CP.24	Max. ramp current	0...200	1	%	-
CP.25	Max. constant current	0...200	1	%	-
CP.26	speed search condition	0...31 B/C: 0...15	1	-	E
CP.27	quick stop dec time	0,00...300,00	0,01	s	-
CP.28	Response of ext. overtemperature.	0...9 B/C: 0...7	1	-	-
CP.29	ANOUT1 function	0...29 B/C: 0...26	1	-	E
CP.30	ANOUT1 gain	-20,00...20,00	0,01	-	-
CP.31	relay output 1 / function	0...100 B/C: 0...84	1	-	E

further on next side

CP.32	relay output 2 / function	0...100 B/C: 0...84	1	-	E	
CP.33	relay output 2 / switching level	±30000,00	0,01	-	-	
CP.34	rotation source	0...10 B/C: 0...9	1	-	E	
CP.35	AN1 interface selection	0...2	1	-	E	
CP.36	AN1 zero clamp	-10,0...10,0	0,1	%	-	
LTK=depending on power unit; E=ENTER parameter						
B/C = Basic and Compact						

Parameter Description

6.2 Quick guide for operating mode „MULTI“

Parameter	Setting range	Resolution	Unit	E	Customer setting
CP.00	password input	0...9999	1	–	–
CP.01	encoder 1 speed	±4000	0,125	rpm	–
CP.02	set value display	±4000	0,125	rpm	–
CP.03	inverter state	0...255	1	–	–
CP.04	apparent current	0...6553,5	0,1	A	–
CP.05	peak apparent current	0...6553,5	0,1	A	–
CP.06	actual torque	±32000,00	0,01	Nm	–
CP.07	actual DC voltage	0...1500	1	V	–
CP.08	peak DC voltage	0...1500	1	V	–
CP.09	output voltage	0...1167	1	V	–
CP.10	speed control configuration	0(off)...127	1	–	–
CP.11	DASM rated speed	0...64000	1	rpm	–
CP.12	DASM rated frequency	0,0...1600,0	0,1	Hz	–
CP.13	DASM rated current	0,0...1500,0	0,1	A	–
CP.14	DASM rated voltage	120...830	1	V	–
CP.15	DASM cos (phi)	0,50...1,00	0,01	–	–
CP.16	DASM rated power	0,10...1000,00	0,01	kW	–
CP.17	load mot. dependent para.	0...3	1	–	E
CP.18	boost	0,0...25,5	0,1	%	–
CP.19	rated frequency	0...400	0,0125	Hz	–
CP.20	encoder 1 (inc/r)	1...65535	1	Inc	E
CP.21	encoder 1 rotation	0...19	1	–	E
CP.22	Maximum speed	0...4000	0,125	rpm	–
CP.23	step value 1	±4000	0,125	rpm	–
CP.24	step value 2	±4000	0,125	rpm	–
CP.25	acc. time forward	0,00...300,00	0,01	s	–
CP.26	deceleration time (-0.01=CP.25)	-0,01...300,00	0,01	s	–
CP.27	S-curve time	0.00(off)...5.00	0,01	s	–
CP.28	Torque reference source	0...6	1	–	E
CP.29	absolute torque reference	±32000,00	0,01	Nm	–
CP.30	KP speed	0...32767	1	–	–
CP.31	KI speed	0...32767	1	–	–
CP.32	switching frequency	2/4/8/12/16 (LTK)	1	kHz	E
CP.33	relay output 1 / function	0...100	1	–	E
CP.34	relay output 2 / function	0...100	1	–	E
CP.35	Limit switch / stopping mode	0...6	1	–	–
CP.36	External Fault / stopping mode	0...6	1	–	–

LTK = dep. on power circuit (see chapter 3.3); E=ENTER parameter

6.3 Factory setting for operating mode „SERVO“

Parameter	Setting range	Resolution	Unit	E	Customer setting
CP.00	password input	0...9999	1	-	-
CP.01	encoder 1 speed	±4000	0,125	rpm	-
CP.02	set value display	±4000	0,125	rpm	-
CP.03	inverter state	0...255	1	-	-
CP.04	apparent current	0...6553,5	0,1	A	-
CP.05	peak apparent current	0...6553,5	0,1	A	-
CP.06	actual torque	±32000,00	0,01	Nm	-
CP.07	actual DC voltage	0...1500	1	V	-
CP.08	peak DC voltage	0...1500	1	V	-
CP.09	output voltage	0...1167	1	V	-
CP.10	speed control configuration	4...6	1	-	-
CP.11	DSM rated torque	0,1...6553,5	0,1	Nm	-
CP.12	DSM rated speed	0...32000	1	rpm	-
CP.13	DSM rated frequency	0,0...1600,0	0,1	Hz	-
CP.14	DSM rated current	0,0...1500,0	0,1	A	-
CP.15	DSM EMC voltage constant	0...32000	1	V	-
CP.16	DSM motor winding inductance	0,01...500,00	0,01	mH	-
CP.17	DSM motor winding resistance	0,000...150,000	0,001	Ω	-
CP.18	DSM rated motor current	0,0...1490,0	0,1	A	-
CP.19	load mot. dependent para.	0...3	1	-	E
CP.20	absolute position enc.1	0...65535	1	-	-
CP.21	encoder 1 rotation	0...19	1	-	-
CP.22	max. reference forward	0...4000	0,125	rpm	-
CP.23	step value 1	±4000	0,125	rpm	-
CP.24	step value 2	±4000	0,125	rpm	-
CP.25	acc. time forward	0,00...300,00	0,01	s	-
CP.26	deceleration time (0.01=CP.25)	-0,01...300,00	0,01	s	-
CP.27	s-curve time 0.00=off	0,00...5,00	0,01	s	-
CP.28	Torque reference source	0...6	1	-	E
CP.29	absolute torque reference	±32000,00	0,01	Nm	-
CP.30	KP speed	0...32767	1	-	-
CP.31	KI speed	0...32767	1	-	-
CP.32	switching frequency	0...2/4/8/12/16(LTK)	1	-	E
CP.33	relay output 1 / function	0...100	1	-	E
CP.34	relay output 2 / function	0...100	1	-	E
CP.35	Limit switch / stopping mode	0...6	1	-	-
CP.36	E.EF stopping mode	0...6	1	-	-

LTK=depending on power unit; E=ENTER parameter

Passwords

7. Passwords

Read only		Read/Write		Drive Mode
100		200		500

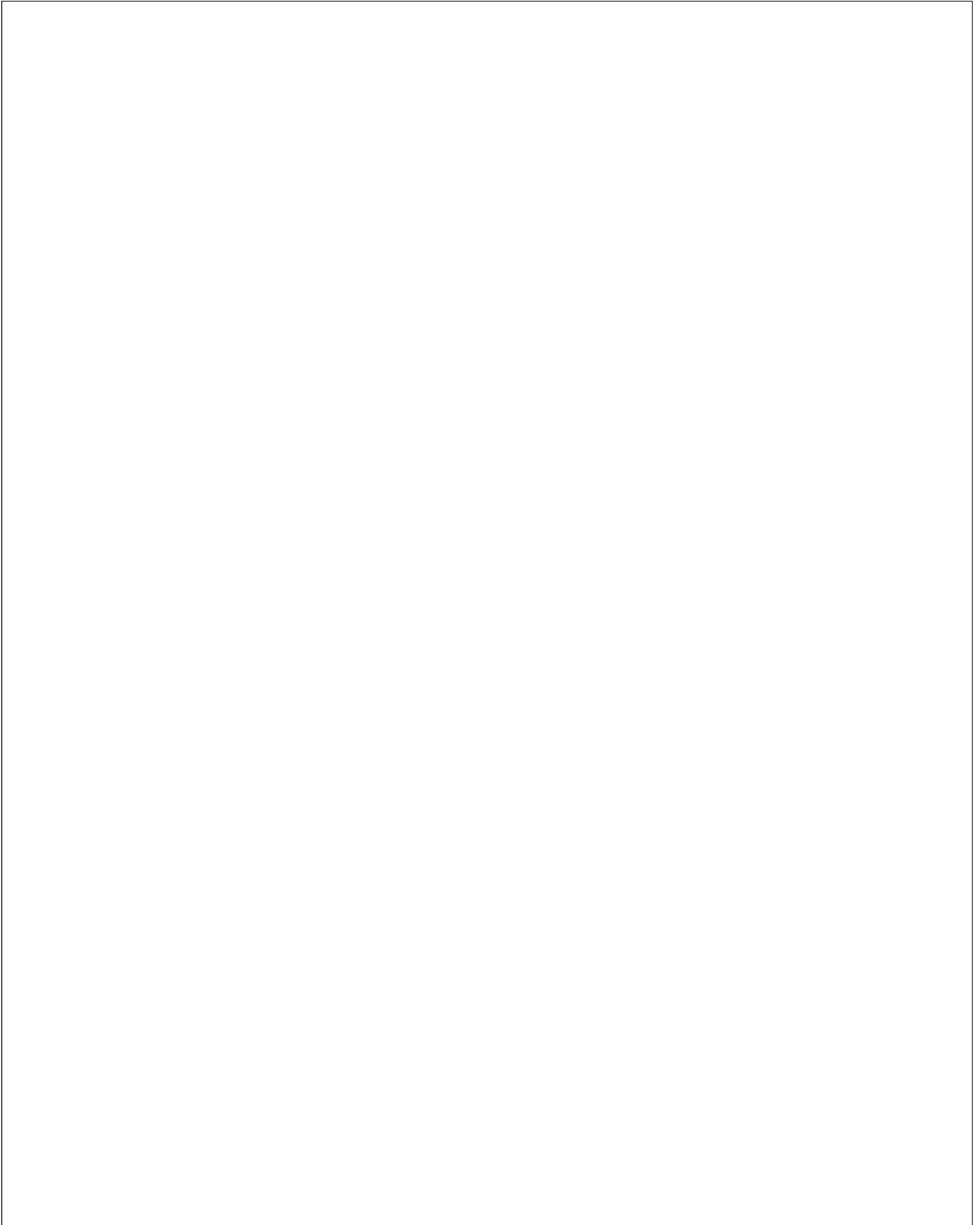



KEB Automation KG

Südstraße 38 • D-32683 Barntrup
fon: +49 5263 401-0 • fax: +49 5263 401-116
net: www.keb.de • mail: info@keb.de

KEB worldwide...

KEB Antriebstechnik Austria GmbH

Ritzstraße 8 • A-4614 Marchtrenk
fon: +43 7243 53586-0 • fax: +43 7243 53586-21
net: www.keb.at • mail: info@keb.at

KEB Antriebstechnik

Herenveld 2 • B-9500 Geraadsbergen
fon: +32 5443 7860 • fax: +32 5443 7898
mail: vb.belgien@keb.de

KEB Power Transmission Technology (Shanghai) Co.,Ltd.

No. 435 Qianpu Road, Chedun Town, Songjiang District,
CHN-Shanghai 201611, P.R. China
fon: +86 21 37746688 • fax: +86 21 37746600
net: www.keb.de • mail: info@keb.cn

KEB Antriebstechnik Austria GmbH

Organizační složka
K. Weise 1675/5 • CZ-370 04 České Budějovice
fon: +420 387 699 111 • fax: +420 387 699 119
mail: info.keb@seznam.cz

KEB Antriebstechnik GmbH

Wildbacher Str. 5 • D-08289 Schneeberg
fon: +49 3772 67-0 • fax: +49 3772 67-281
mail: info@keb-drive.de

KEB España

C/ Mitjer, Nave 8 - Pol. Ind. LA MASIA
E-08798 Sant Cugat Sesgarrigues (Barcelona)
fon: +34 93 897 0268 • fax: +34 93 899 2035
mail: vb.espana@keb.de

Société Française KEB

Z.I. de la Croix St. Nicolas • 14, rue Gustave Eiffel
F-94510 LA QUEUE EN BRIE
fon: +33 1 49620101 • fax: +33 1 45767495
net: www.keb.fr • mail: info@keb.fr

KEB (UK) Ltd.

Morris Close, Park Farm Industrial Estate
GB-Wellingborough, NN8 6 XF
fon: +44 1933 402220 • fax: +44 1933 400724
net: www.keb.co.uk • mail: info@keb.co.uk

KEB Italia S.r.l.

Via Newton, 2 • I-20019 Settimo Milanese (Milano)
fon: +39 02 3353531 • fax: +39 02 33500790
net: www.keb.de • mail: kebitalia@keb.it

KEB Japan Ltd.

15-16, 2-Chome, Takanawa Minato-ku
J-Tokyo 108-0074
fon: +81 33 445-8515 • fax: +81 33 445-8215
mail: info@keb.jp

KEB Korea Seoul

Room 1709, 415 Missy 2000
725 Su Seo Dong, Gang Nam Gu
ROK-135-757 Seoul/South Korea
fon: +82 2 6253 6771 • fax: +82 2 6253 6770
mail: vb.korea@keb.de

KEB RUS Ltd.

Lesnaya Str. House 30, Dzerzhinsky (MO)
RUS-140091 Moscow region
fon: +7 495 632 0217 • fax: +7 495 632 0217
net: www.keb.ru • mail: info@keb.ru

KEB America, Inc.

5100 Valley Industrial Blvd. South
USA-Shakopee, MN 55379
fon: +1 952 224-1400 • fax: +1 952 224-1499
net: www.kebamerica.com • mail: info@kebamerica.com

More and latest addresses at <http://www.keb.de>

© KEB	
Document	20104044
Part/Version	GBR 00
Date	2016-10-07