

Solenoids

GP... - B7... - G93 - U7... - U7...EX - G7... - A8... - B8... - H8... - B9...

Version A and B

Connections according to industrial standard
and to DIN EN 175 301-803 standards

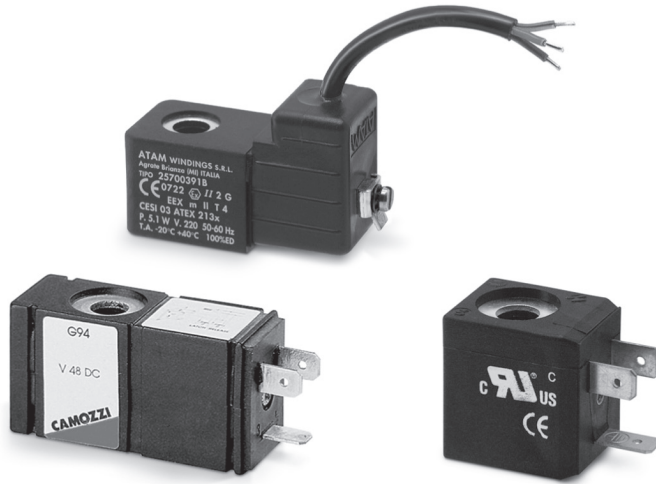

The mechanical part of the tube in the solenoid valves Series A, 3, 4, 9 and NA allows the mounting of various types of solenoids.

- » Mod. GP...: in compliance with industrial standard (9.4mm) and designed to be mounted only on Series AP proportional valves, size 16 mm.
- » Mod. B...: to be used only with Series CFB solenoid valves (2/1.30).
- » Mod. G93: special solenoids with incorporated memory for pulsed operation.
- » Mod. U7...: standard solenoids are certified by UL as Recognized Component for USA and Canada. Solenoids Mod. U7 are available also with ATEX certification.
- » Mod. H8...: explosion-proof solenoids suitable for potentially explosive ambients (ATEX, IECEx).

GENERAL DATA

	U7... / G7... / G93	A8...	B...	H8...
Wire insulation	class F (155° C)	class H (180° C)	class H (200° C)	class H (200° C)
Protection class	IP54 - DIN 40050	IP54 - DIN 40050	IP54 - DIN 40050	IP64
	IP65 (with connector Mod. 122-800 and Mod. 122-800EX)	IP65 (with connector Mod. 124-800)	IP65 (with connector Mod. 124-800)	
Operation	ED 100%	ED 100%	ED 100%	ED 100%
Tolerance V AC	-15% / +10%	-15% / +10%	±10%	-
Tolerance V DC	±10%	±10%	±5%	-

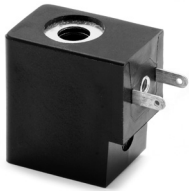

Solenoids Mod. GP...

Electrical connection: bipolar
Norm: industrial standard (9.4 mm)

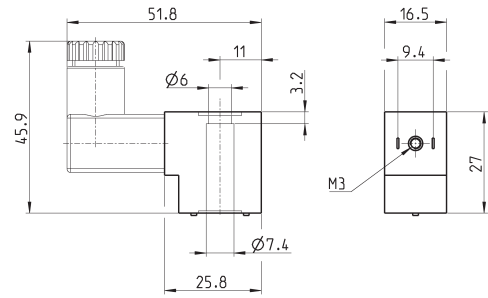
Solenoid material: PA

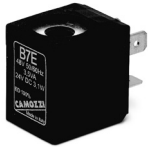

Mod.	Solenoid voltage	Power absorption
GPH	12 V DC	3 W
GP7	24 V DC	3 W

Solenoids Mod. B7...

Electrical connection: bipolar plus earth
Norm: DIN EN 175 301-803-B

Solenoid material: PA-MXD6

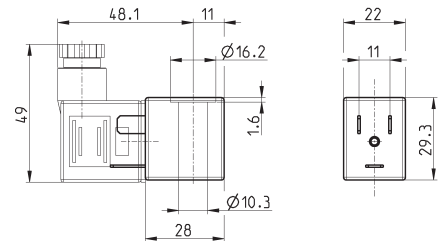

Mod.	Solenoid voltage	Power absorption
B7B	24 V - 50/60 Hz	9 VA
B7D	110 V - 50/60 Hz	9 VA
B7E	230 V - 50/60 Hz	9 VA
B7H	24 V - 50/60 Hz	4 VA
B72	12 V - DC	10 W
B73	24 V - DC	10 W
B74	24 V - DC	7 W

Solenoids Mod. G93 (with memory)

Electrical connection: bipolar plus earth
Norm: DIN EN 175 301-803-B
Voltage tolerance: $\pm 10\%$
Pulsed operation (see description)

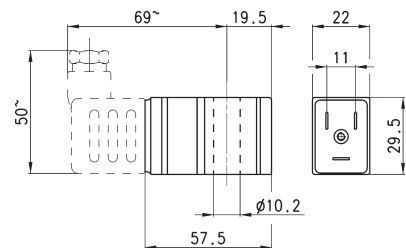

Mod.	Voltage	Minimum impulse latch/release	Consumption latch/release
G93	24 V DC	18 ms - 10 ms	168 mA - 80 mA

Description of solenoids Mod. G9...

Solenoids Mod. G9... can be replaced on all other Series

A solenoid valves or pilots allowing to change the valve functioning from:

- unstable functioning system (spring return) to:

- stable functioning system (memory)

The stable functioning has the following advantages:

- with an impulse of about 20 ms after which the valve always remains in the controlled position.
- the valve remains in the controlled position (opened or closed) even if there is no power.
- when normally opened valves should be used, it is not necessary to use valves with special mechanical parts as a NC valve becomes a NO valve just by changing the control impulse sequence.
- The impulse control system facilitates the utilization with electronic circuits. The minimum required impulse for the function is 20 ms; if, for circuit reasons, the impulse last for a longer period, there is no danger of heating.
- magnet attraction command = Actuation SW1
- magnet release command = Actuation SW2

If the solenoids are mounted in batteries, a magnetic scheme type G90/L should be used.

To facilitate the cabling a special connector is available, which contains a circuit which realises the inversion of the power supply to the solenoid, indispensable for the PLC command, 122-892 P with common positive or 122-893 N with common negative.

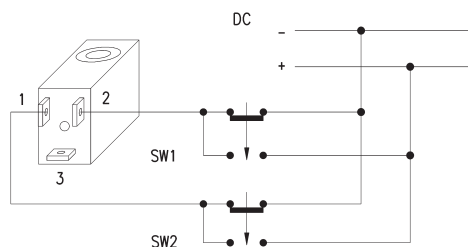
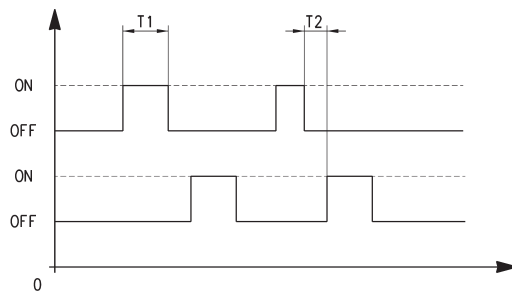

Solenoids Mod. U7... / U7*EX and Mod. G7...



Electrical connection: bipolar plus earth
 Norm: DIN EN 175 301-803-B
 Solenoid material: U7* = PET: G7* = PA
 To order the ATEX version of Mod. U7 (not available for Mod. U7F, U7K1 with voltage 125V 50/60Hz) it is necessary to add EX at the end of the code.
 Mod. U7*EX marked:
 II 3G Ex nA IIC T4 Gc X IP65
 II 3D Ex tc IIIC 130°C Dc X

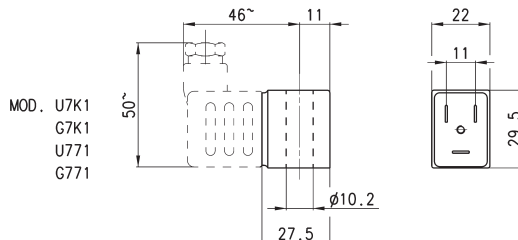
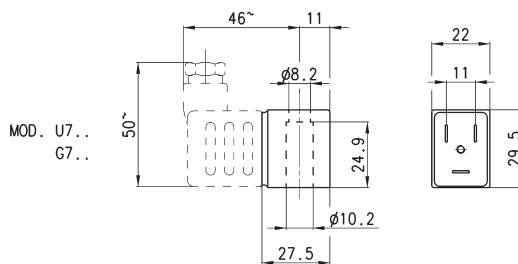

Mod.	Sol. volt. (1)	Pow. abs. (1)	Sol. volt. (2)	Pow. abs. (2)	Sol. volt. (3)	Pow. abs. (3)
U7H	12 V DC	3.1 W	24V - 50/60 Hz	3.5 VA		
G7H	12 V DC	3.1 W	24V - 50/60Hz	3.5 VA		
U7K	110V - 50/60Hz	3.8 VA	125V - 50/60Hz	5.5 VA	72 V DC	4.8 W
U7K1	110V - 50/60Hz	5.8 VA	125V - 50/60Hz	8.3 VA	72 V DC	5.6 W
G7K	110V - 50/60Hz	3.8 VA	125V - 50/60Hz	5.5 VA	72 V DC	4.8 W
G7K1	110V - 50/60Hz	5.8 VA	125V - 50/60Hz	8.3 VA	72 V DC	5.6 W
U7J	230V - 50/60Hz	3.5 VA	240V - 50/60Hz	4 VA		
G7J	230V - 50/60Hz	3.5 VA	240V - 50/60Hz	4 VA		
U79	48 V DC	3.1 W				
G79	48 V DC	3.1 W				
U710	110 V DC	3.2 W				
G710	110 V DC	3.2 W				
U77	24 V DC	3.1 W	48V - 50/60Hz	3.8 VA		
U771	24 V DC	3.1 W	48V - 50/60Hz	3.8 VA		
G77	24 V DC	3.1 W	48V - 50/60Hz	3.8 VA		
G771	24 V DC	3.1 W	48V - 50/60Hz	3.8 VA		
U7F	380V - 50/60Hz	7 VA				
U72	12 V DC	5 W				
G72	12 V DC	5 W				
U73	24 V DC	5 W				
G73	24 V DC	5 W				

Notes to the table:
 Sol. volt. = Solenoid voltage
 Pow. abs. = Power absorption

Mod. U7K1, G7K1, U771 and G771 are to be used only with sol. valves series A, NO in line.

Solenoids Mod. A8...



Electrical connection: bipolar plus earth
Norm: DIN EN 175 301-803-A

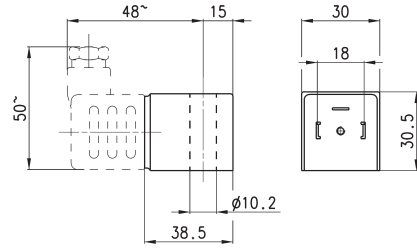

Mod.	Solenoid voltage	Power absorption
A8B	24V - 50/60Hz	5VA
A8D	110V - 50/60Hz	5VA
A8E	220V - 50/60Hz	5VA
A83	24V DC	4W

Solenoids for solenoid valves Series A, 3, 4, 9 and NA

All solenoids presented can be mounted on the following solenoid valves: Series A - 3 - 4 - 9 - NA

NB:

For the tightening of the solenoids' nut we recommend to do it manually, avoiding the use of any equipment.

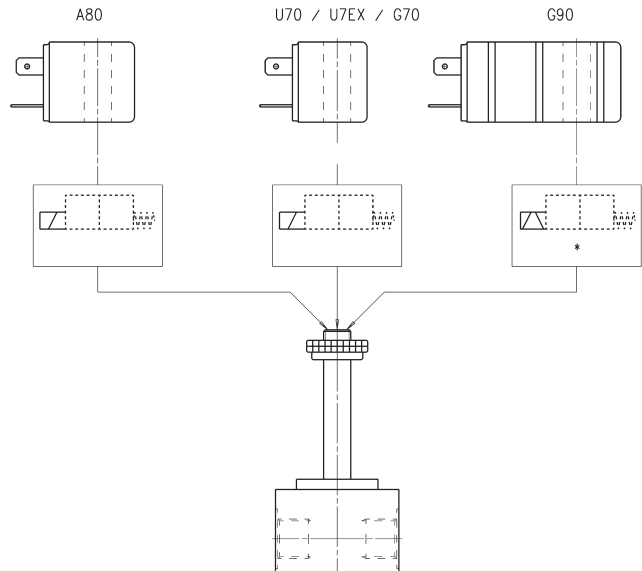

Solenoids Mod. B8...

Electrical connection: bipolar plus earth
Norm: DIN EN 175 301-803-A

Solenoid material: PA-MXD6

The B8*K models can be used only with some solenoid valves Series CFB (Mod. CFB-D1..., 2/2 NO).
Further details on page 2/1.30.03.

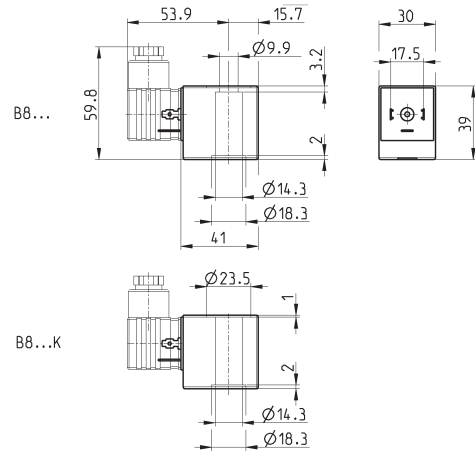

Mod.	Solenoid voltage	Power absorption
B8B	24 V - 50 Hz	15 VA
B8BK	24 V - 50 Hz	15 VA
B8D	110 V - 50/60 Hz	15 VA
B8DK	110 V - 50/60 Hz	15 VA
B8E	220/230 V - 50/60 Hz	15 VA
B8EK	230 V - 50/60 Hz	15 VA
B8F	220/230 V - 50/60 Hz	21 VA
B8FK	220/230 V - 50/60 Hz	21 VA
B82	12 V - DC	19 W
B82K	12 V - DC	19 W
B83	24 V - DC	19 W
B83K	24 V - DC	19 W

Solenoid Mod. H8.. for potentially explosive ambients

Certification in compliance with
EN 60079-0 EN 60079-18

ATEX :
II 2G Ex mb IIC T4 Gb
II 2D Ex mb IIIC T135°C Db
I M2 Ex mb I Mb
INERIS 06ATEX0002X

IECEX :
Ex mb IIC T4 Gb
Ex mb IIIC T135°C Db
Ex mb I Mb
IECEX INE 15.0053X

For Series NA use plate mod.
NA54-PC.

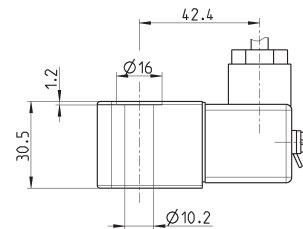
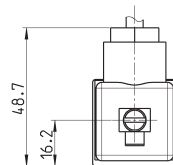
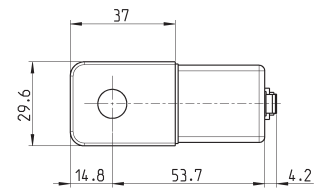

Mod.	Solenoid voltage	Power absorption
H8BI	24 V - DC	5.3 W
H8BI	24 V - 50/60 Hz	5.3 W
H8CI	48 V - 50/60 Hz	5.3 W
H8DI	110 V - 50/60 Hz	5.3 W
H8EI	230 V - 50/60 Hz	5.3 W

Temperature class/Max surface temperature: T4/135°C
Environment temperature: -20°C + 40°C
Connection: tripolar cable 3 m (other lengths on request)
Incapsulating material: self-extinguishing PA.

Solenoids Mod. B9...

Electrical connection: bipolar plus earth
Norm: DIN EN 175 301-803-A

Solenoid material: PA-MXD6

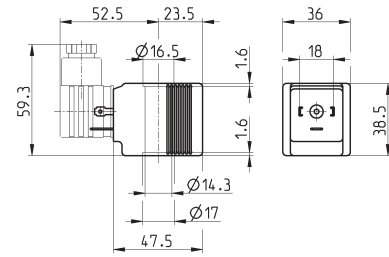

Mod.	Solenoid voltage	Power absorption
B9B	24 V - 50 Hz	29 VA
B9D	110 V - 50/60 Hz	29 VA
B9E	230 V - 50 Hz	29 VA
B92	12 V - DC	30 W
B93	24 V - DC	30 W

Connectors Mod. 122-... DIN EN 175 301-803-B

For solenoids Mod. U7/U7*EX, G7 and B7

Mod. 122-800EX:
for ATEX certified solenoids mod. U7*EX, with anti-screwing off screw mod. TORX.

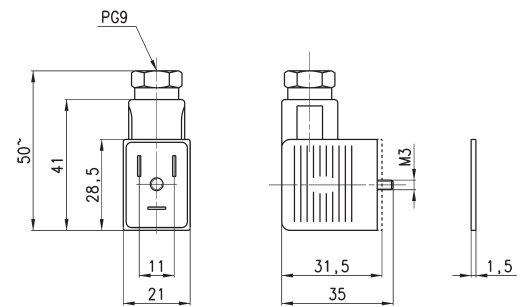

Mod.	description	colour	working voltage	cable holding	tightening torque
122-601	connector, diode + Led	transparent	10/50 V DC	PG9	0.5 Nm
122-701	connector, varistor + Led	transparent	24 V AC/DC	PG9	0.5 Nm
122-702	connector, varistor + Led	transparent	110 V AC/DC	PG9	0.5 Nm
122-703	connector, varistor + Led	transparent	230 V AC/DC	PG9	0.5 Nm
122-800	connector, without electronics	black	-	PG9	0.5 Nm
122-800EX	connector, without electronics	black	-	PG9	0.5 Nm

Connectors Mod. 122-5... DIN EN 175 301-803-B with cable

For solenoids Mod. U7/U7*EX, G7 and B7

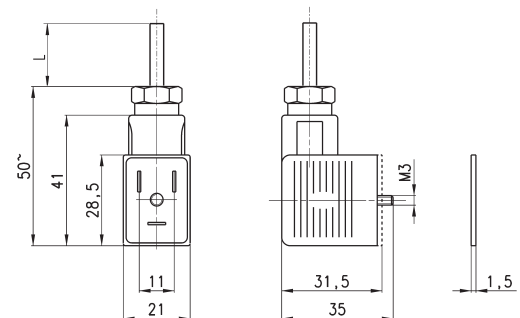

Mod.	description	colour	working voltage	cable length [L]	cable holding	tightening torque
122-550-1	moulded cable, without electronics	black	-	1000 mm	-	0.5 Nm
122-550-5	moulded cable, without electronics	black	-	5000 mm	-	0.5 Nm
122-571-3	moulded cable, varistor + Led	black	-	3000 mm	-	0.5 Nm

Connectors Mod. 122-89*C DIN EN 175 301-803-B

For solenoids Mod. G9

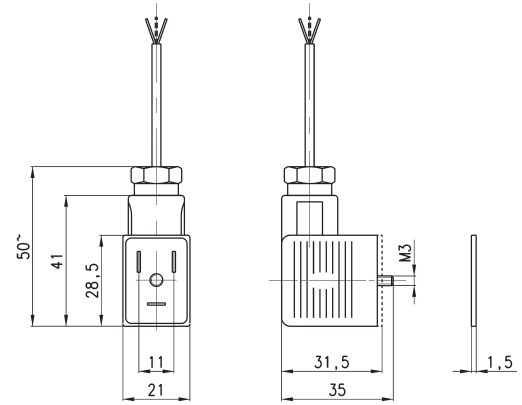

Mod.	description	colour	working voltage	cable length [L]	cable holding	tightening torque
122-892C	pre-wired connector, positive common	transparent	12/24V DC	2000 mm	PG9	0.5 Nm
122-893C	pre-wired connector, negative common	transparent	12/24V DC	2000 mm	PG9	0.5 Nm

Connector Mod. 124-... DIN EN 175 301-803-A

For solenoids Mod. A8 and Mod. B8/B9

Protection class IP65

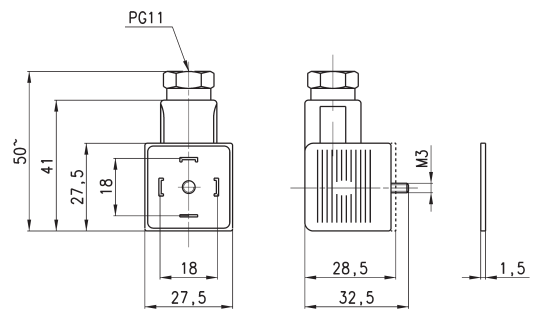

Mod.	description	colour	working voltage	cable holding	tightening torque
124-800	connector, without electronics	black	-	PG9/PG11	0.5 Nm
124-702	connector, varistor + Led	black	110 V AC/DC	PG9/PG11	0.5 Nm
124-701	connector, varistor + Led	black	24 V AC/DC	PG9/PG11	0.5 Nm
124-703	connector, varistor + Led	black	230 V AC/DC	PG9/PG11	0.5 Nm