

Type H3F Load Cell



Short description



- Nickel plated alloy steel IP67 "S" type load cell
- Tension and compression applications
- Suitable for hanging, hopper and other weighing devices
- Also available in imperial capacities and dimensions

Non OIML approved



Certificate no. 06-099A1

Available models

Capacity	Accuracy	Full article description
100kg	C3	H3F-C3-100kg-6T
250kg	C3	H3F-C3-250kg-6T
500kg	C3	H3F-C3-500kg-6T
750kg	C3	H3F-C3-750kg-6T
1t	C3	H3F-C3-1t-6T
1.5t	C3	H3F-C3-1.5t-6T
2t	C3	H3F-C3-2t-6T
2.5t	C3	H3F-C3-2.5t-6T
5t	C3	H3F-C3-5t-6T

Specifications and dimensions are subject to change without notice and do not constitute any liability whatsoever.

Type H3F Load Cell

Detailed specifications H3F

Accuracy class		C3
Output sensitivity (= FS)	mV/V	3.0 ± 0.008
Maximum capacity (E _{max})	t	0.1, 0.25, 0.5, 0.75, 1, 1.5, 2, 2.5, 5
Max.number of load cell intervals	n _{LC}	3000
Ratio of min. LC verification interval	$Y = E_{max} / v_{min}$	10000
Combined Error	%FS	≤± 0.020
Minimum dead load	Of E _{max}	0%
Safe overload	of E _{max}	150 %
Ultimate overload	of E _{max}	300 %
Zero balance	of FS	< ± 1.0 %
Excitation, recommended voltage	V	5 ~ 12
Excitation maximum	V	18
Input resistance	Ω	350 ± 3.5
Output resistance	Ω	351 ± 2.0
Insulation resistance	MΩ	≥5000 (at 50VDC)
Compensated temperature	°C	-10 ~ +40
Operating temperature	°C	-35 ~ +65
Storage temperature	°C	-40 ~ +70
Element material		Nickel plated alloy steel
Ingress Protection (acc. to EN 60529)		IP67
Recommended torque on fixation	Nm	M10: 50 M12:75 M18: 300
ATEX classification (optional)		II1G Ex ia II1C T4 II1D Ex iaD 20 T73°C II3G nL IIC T4

Wiring

Wiring:

Shielded, 4 conductor cable.
 Cable diameter: Ø5mm.
 Standard cable length: 6m.
 Shield not connected to element

4-wire diagram

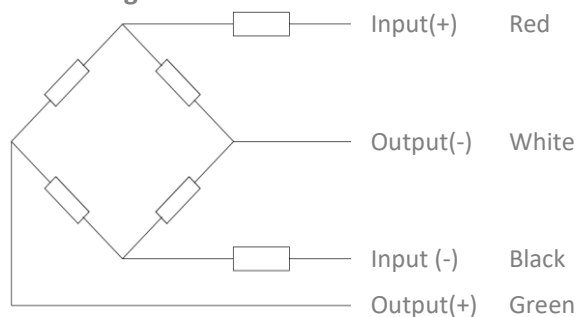

Specifications and dimensions are subject to change without notice and do not constitute any liability whatsoever.

Type H3F Load Cell

Dimensions in mm

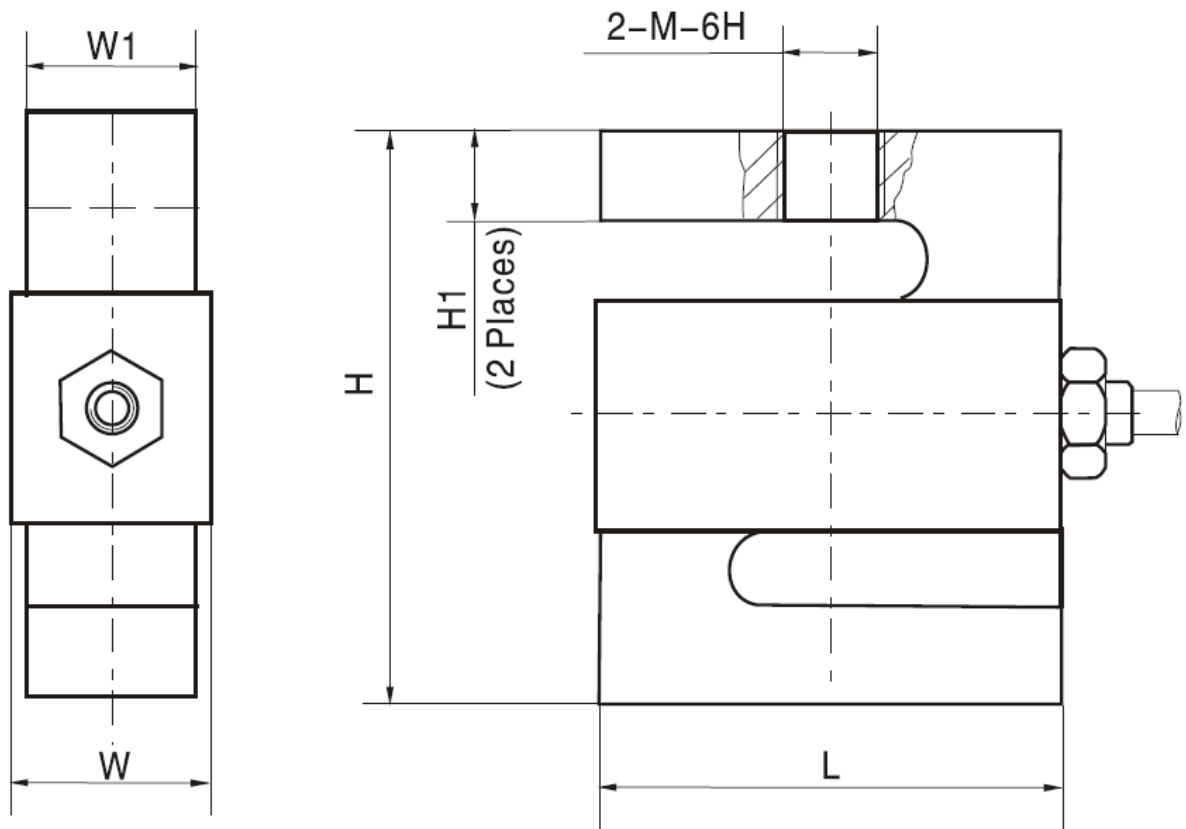

Dimension Capacity	H	W	W1	L	H1	M
100kg	76.2	20.6	19	50.8	15.8	M10 x 1.5
250kg	76.2	20.6	19	50.8	15.12	M12 x 1.75
500kg	76.2	20.6	19	50.8	14.2	M12 x 1.75
750kg	76.2	20.6	19	50.8	13.46	M12 x 1.75
1t	76.2	27	25.4	50.8	13.24	M12 x 1.75
1.5t	76.2	27	25.4	50.8	11.82	M12 x 1.75
2t	108	27	25.4	76.2	26.7	M18 x 1.5
2.5t	108	27	25.4	76.2	25.48	M18 x 1.5
5t	108	27	25.4	76.2	20.26	M18 x 1.5

Specifications and dimensions are subject to change without notice and do not constitute any liability whatsoever.

Type H3F Load Cell

Available accessories

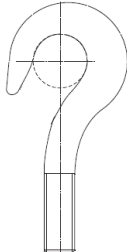
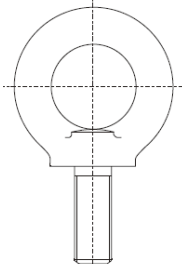
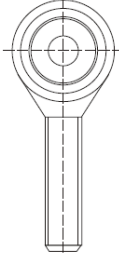
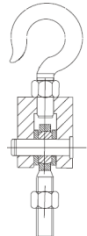
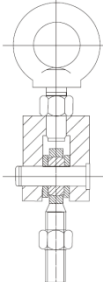
<p>HL-3-001-25kg-5t hook</p> <ul style="list-style-type: none">• Alloy Steel• Suitable for hybrid scales, crane scales, packaging scales and hopper scales	
<p>HL-3-002-25kg-5t eye</p> <ul style="list-style-type: none">• Alloy Steel• Suitable for hybrid scales, crane scales, packaging scales and hopper scales	
<p>HL-3-003-25kg-5t rod end</p> <ul style="list-style-type: none">• Alloy Steel• Suitable for hybrid scales, crane scales, packaging scales, hopper scales and other electronic weighing devices.	
<p>HL-3-004-25kg-5t hook assembly</p> <ul style="list-style-type: none">• Alloy Steel• Suitable for hybrid scales, crane scales, packaging scales, hopper scales and other electronic weighing devices.	
<p>HL-3-005-25kg-5t eye assembly</p> <ul style="list-style-type: none">• Alloy Steel• Suitable for hybrid scales, crane scales, packaging scales, hopper scales and other electronic weighing devices.	

Specifications and dimensions are subject to change without notice and do not constitute any liability whatsoever.