



www.gearmotor.co.kr
www.smservo.co.kr

SMS

AC & DC STANDARD GEAR MOTOR



SMS SHINMYUNG SERVO CO., LTD.

■ OUTLINE

The MOTORS supplied by SHINMYUNG SERVO CO.,LTD. are widely utilized as AC & DC STANDARD SMALL MOTORS, which are standardized with all kinds of gear heads to meet diversified customer's demands.

These motors are designed and manufactured for high accuracy, stability and durability by the support of SHINMYUNG ELECTRIC Mfg Co., Ltd. high-level design capability, mass production technology and 40 year's experience.

From now our company can supply the motors with reasonable price and high quality to the customers as quickly as possible and acquire CE U.L. CSA and VDE mark by your demands.

■ FEATURES

1. INDUCTION motors are used for continuous duty applications to the same direction in the long time, but as reversible motors is used for frequent starting and stopping characteristics, these motors are designed specially for high starting torque. Therefore, REVERSIBLE motors are applied for normal rotation, stop, reverse rotation alternately in the short time.
2. The customer can select all kinds of gear heads that suit with each motor. Standard gear ratios are divided into 20 steps in the range from 1/3 to 1/180. Depend on the demand, the ratio can be available from 1/30 to 1/1800 with a decimal gearhead.
3. As the strength of gear heads are designed optimally for motors output, these motors can be stably available for wide range of gear ratio.
4. As the motors are assembled by using standard parts, whose quality is stable and also these motors are designed and manufactured for low noise, low vibration and long life expectancy.

■ UL, CE Certificates

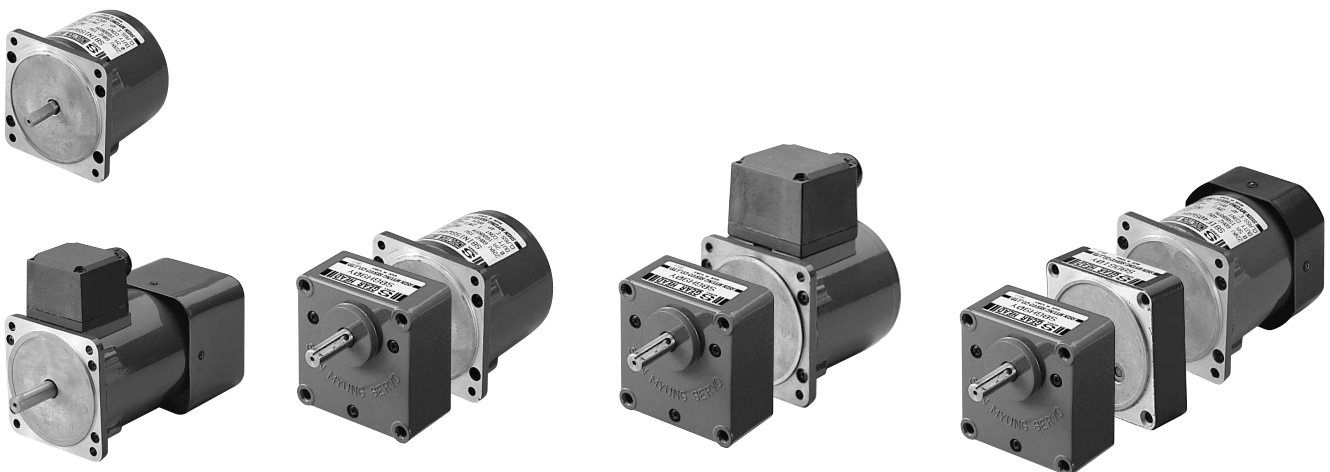
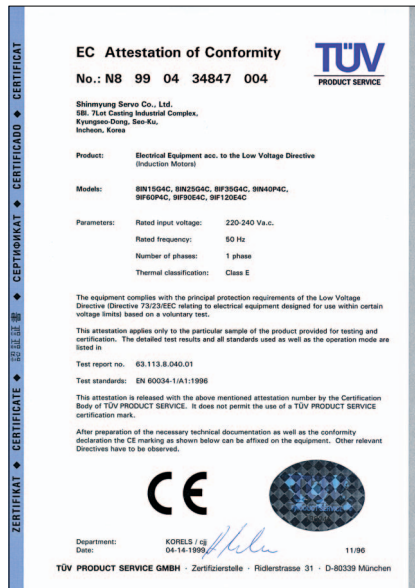
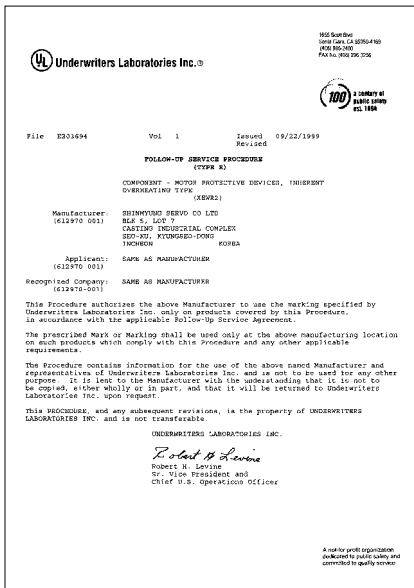

CONTENTS

1. CODING SYSTEM	4p
2. HOW TO HANDLE	6p
3. AC MOTOR SERIES	
- INDUCTION MOTOR	10p
- CE APPROVAL	16p
- UL APPROVAL	24p
- 3 PHASE INDUCTION MOTOR	32p
- 2 POLE INDUCTION MOTOR	36p
- REVERSIBLE MOTOR	37p
- SPEED CONTROL MOTOR & CONTROLLER	44p
- MAGNETIC BRAKE MOTOR	54p
4. DC MOTOR SERIES	
- DC MOTOR & CONTROLLER	64p
5. WORM GEARHEAD	70p

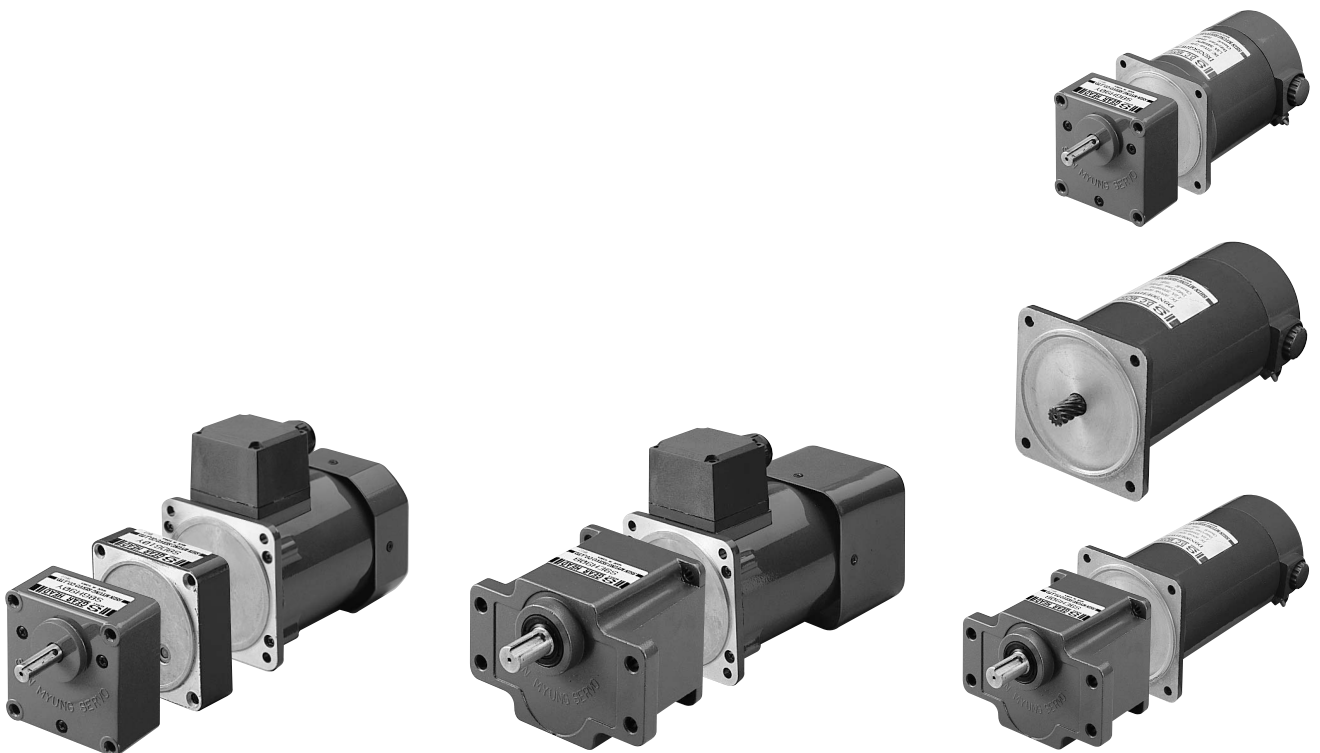

CODING SYSTEM

AC MOTOR & DC MOTOR

MODEL

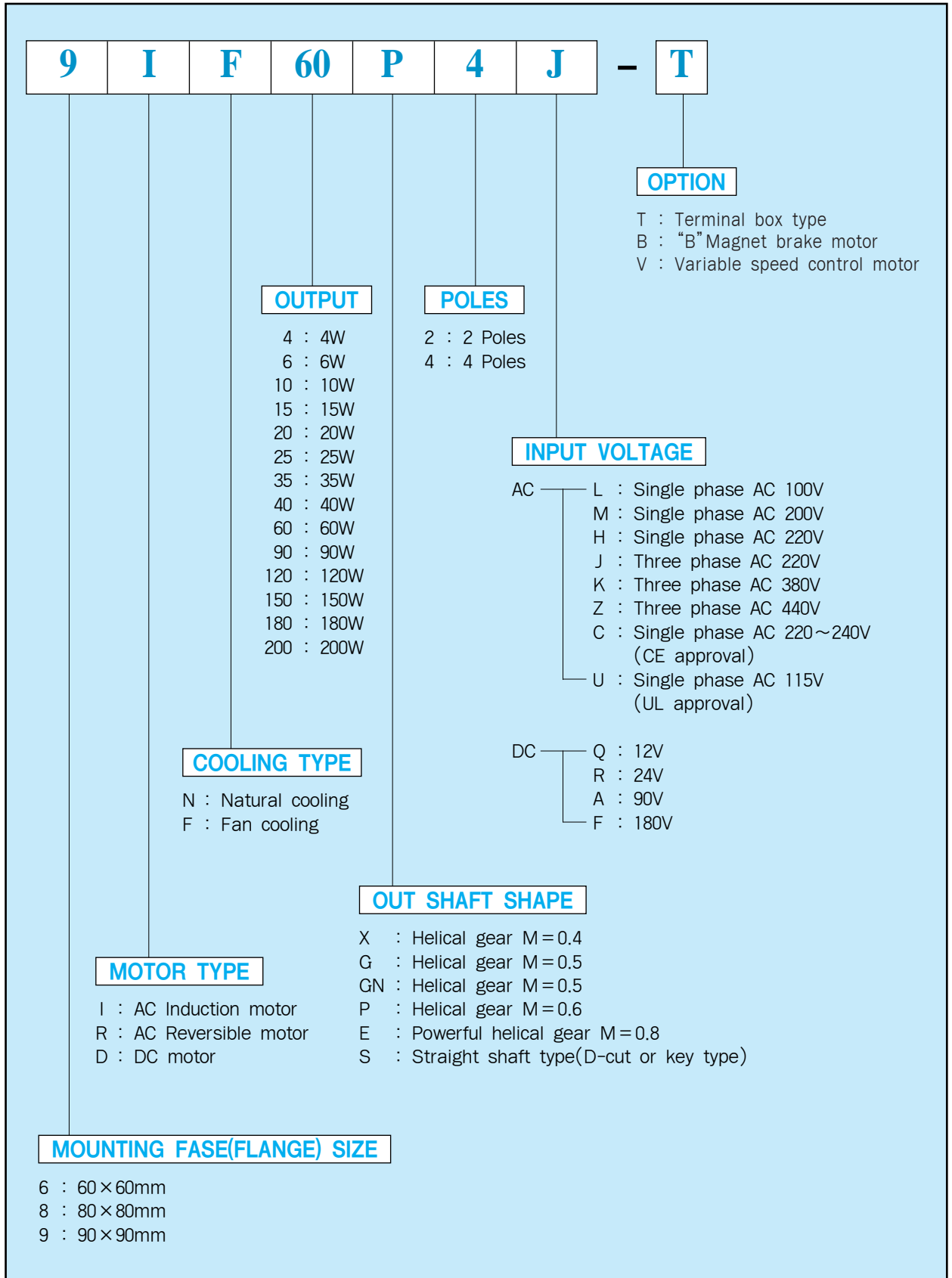

CODING SYSTEM

GEARHEAD

MODEL

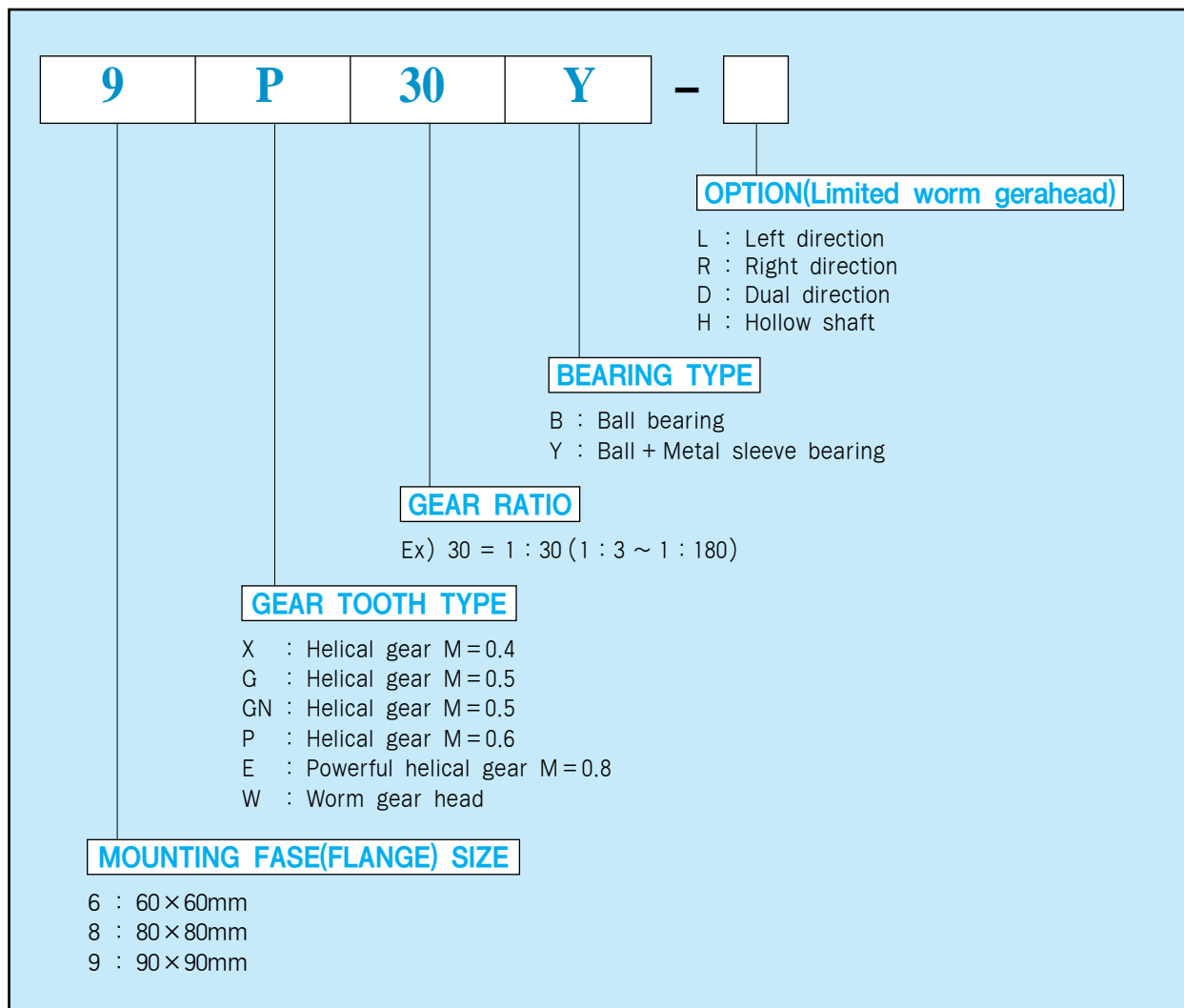

◆ DECIMAL GEAR HEAD

Decimal gearhead is a mediate gearbox which is assembled between a motor and a gearhead to get the transmission ratio 1:250~1:1800.

There are two kinds of decimal gearboxes as follows:

MODEL	REDUCTION	MOUNTING FASE(FLANGE) SIZE
6DG10Y	1 : 10	60 × 60mm
8DGN10Y	1 : 10	80 × 80mm
9DP10Y	1 : 10	90 × 90mm

HOW TO HANDLE

AC MOTOR

■ CHECK BEFORE OPERATION

- 1) Confirm the name of model, voltage, output, etc.
- 2) In case of single phase motors, an attached condenser must be used. Connect firmly condenser terminal and the lead wires of motor with a pressing terminal or soldering.
- 3) Be careful. There are twice times of voltage of input voltage between the terminals of condenser.
- 4) Do not disassemble and modify.

■ WARNING

- 1) Use the motor at ambient temperature between -10~40°C and humidity at 85%.
- 2) Avoid the following places where ;
 - The sun shines directly.
 - Damp or oily place
 - The places are being vibrated
 - The place is dusty
 - There are flammable materials.
- 3) Make sure that surface temperature of the motor case should not be exceeded 90°C. A same type of gear tooth must be connected between motor and gearhead.

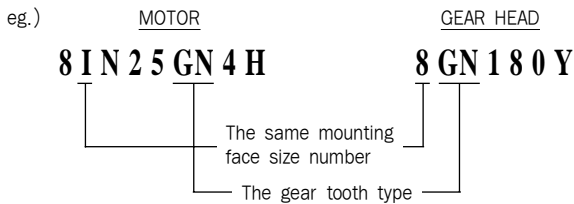

1) Motors and gear head should be connected as belows.

MOTOR	GEAR HEAD	MODULE
X	X	0.4
GN	GN	0.5
P	P	0.6
E	E	0.8

2) Make sure that same model name and number can only be connected.

■ REVERSIBLE MOTORS ARE MADE

For short-time revolution, so that temperature rapidly rises in 30 minutes compared to induction motors.
But the temperatures of the motor case remains cool under 90°C, if the motor dose not work continuously.

■ HOW TO CONNECT THE LEADWIRES

- Try again to connect the leadwires when the following troubles are occurred.
- 1) Motor does not start.
 - 2) Torque is less powerful.
 - 3) When it turns to the wrong direction.
Contact us when the cause is unknown.

!! CAUTION

As the rotation direction of output shaft of an gearhead depends on the ratio. Please confirm the ratio. Only after motor stops, reconnect it to reverse the direction of an induction motor.

!! INDUCTION MOTOR

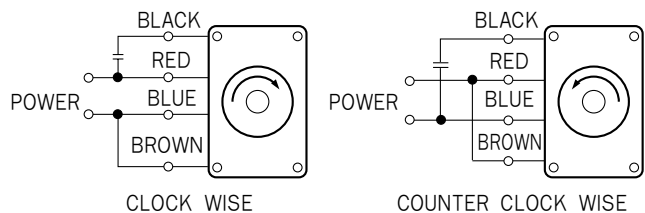

!! REVERSIBLE MOTOR

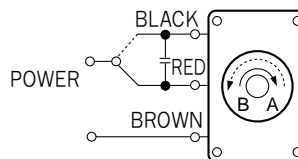

!! 3-phase INDUCTION MOTOR

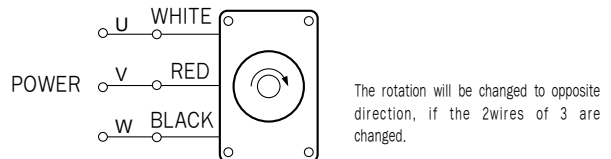

HOW TO HANDLE

GEAR HEAD

AVAILABLE MOTOR

Check the motor and gear head before connect them.
The following motor and gear head can be connected.

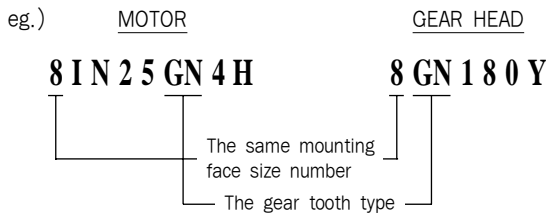

1) Connectable motor and gear tooth type

MOTOR	DECIMAL	GEAR TOOTH	MODULE
X	DX	X	0.4
GN	DGN	GN	0.5
P	DP	P	0.6
E	-	E	0.8

2) Connection can not be done when the gear head types of motor and gearhead types & sizes are different.

ASSEMBLING OF MOTOR AND GEARHEAD

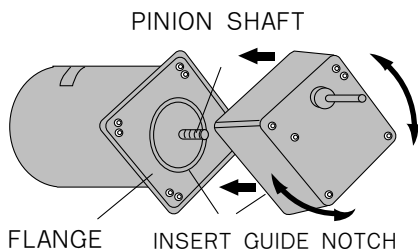

A motor and gearhead must be connected as shown above by turning the gearhead right and left a little repeatedly using the inside guide line with enough care that the pinion does not hit the base-plate or gearhead heavily.

GEAR HEAD OUTPUT SHAFT TURNING DIRECTION

GEAR HEAD	SAME DIRECTION WITH MOTOR	REVERSE DIRECTION WITH MOTOR
6G□Y	3~18, 50~180	25~50
8GN□Y	3~18, 50~180	25~36
9P□Y	3~18, 50~180	25~36
9E□Y	3~9, 25~60	12.5~18, 75~180

ACCESSORIES

- Mounting screw, hex. nut and plain washer
 - • • 4 pcs. each
- Parallel key (Only for key-grooved shaft)
 - • • 1 pc.

GEAR HEAD	SCREW	KEY SIZE
6G3Y ~ 6G18Y	M4 0.7 × 50	-
6G25Y ~ 6G180Y	M4 0.7 × 60	-
8GN3Y ~ 8GN18Y	M5 0.8 × 50	4 × 4 × 25
8GN25Y ~ 8GN180Y	M5 0.8 × 60	4 × 4 × 25
9P3Y ~ 9P18Y	M6 1.0 × 65	4 × 4 × 25
9P25Y ~ 9P180Y	M6 1.0 × 80	4 × 4 × 25
9E3B ~ 6G180B	M6 1.0 × 25	5 × 5 × 25
6DG10Y	M4 0.7 × 90	-
8DGN10Y	M5 0.8 × 90	-
9DP10Y	M6 1.0 × 110	-

Caution in mounting transmission parts

When you mount a pulley, gear or other power transmission part to a Gear Head, take care not to give shock to the output shaft which will affect bearings badly.

In key insertion, especially, never hit with hammer or similar tool.

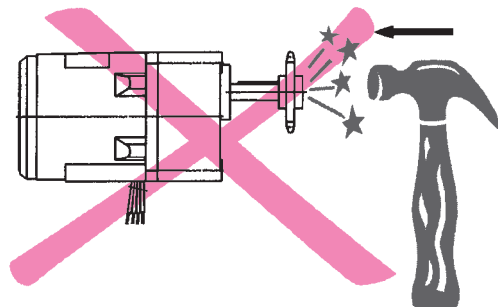

HOW TO HANDLE

GEAR HEAD

THE LIFE OF GEAR HEAD

Generally, the life of the gearhead is determined by the bearing mostly. The bearing life of gearhead is reflected by the friction load transmitted from gearshaft and overhung load and thrust load.

The life of ball bearing type is about 5000 hours in the conditions of the permissible overhung loads and thrust loads with the following operation conditions:

- * Torque : Permissible torque
- * Loads : Continued
- * Hours : 8 hours / day
- * Case temperature : 80°C (Ballbearing Type)

But, generally use the coefficient, which is called the service factor(see table 1) as the loads are changeable a lot of times.

Table 1 service factor

Load class	Service factor(f)		
	5hrs / day	8hrs / day	24hrs / day
Uniform	0.8	1.0	1.5
Moderate shock	1.2	1.5	2.5
Heavy shock	1.5	2.0	2.5

<Load examples>

Uniform	- Velt conveyor - Operation in the same direction continued - Film winding
Moderate shock	- Frequent starting, stopping - CAM running
Heavy shock	- The frequent conversion of reversible motor - The frequent short stop by the brake pack - the conversion of reversible motor (Speed control pack)

PERMISSIBLE OVERHUNG & THRUST LOAD OF GEAR HEAD

Model	Ratio	Allowable Max. Torque		Allowable overhung load		Allowable thrust load	
		Kg-cm	N-m	Kg	N	Kg	N
6G□Y	3~18	30	3	5	50	3	30
6G□B	25~180			15	150		
8GN□Y	3~18	100	10	10	100	5	50
8GN□B	25~180			20	200		
9P□Y	3~18	120	12	25	250	10	100
9P□B	25~180			30	300		
9E□B	3~9	300	30	40	400	15	150
	12.5~36			45	450		
	50~180			50	500		

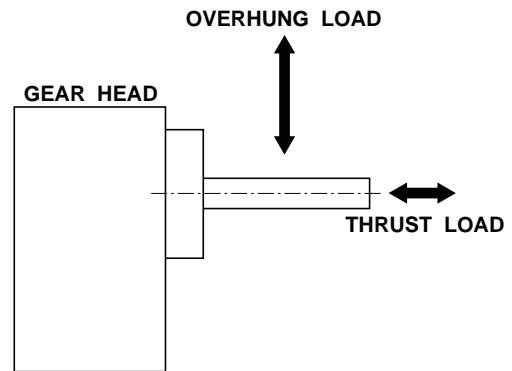

$$* \text{ Overhung load } W = \frac{K \times T \times f}{r}$$

W : Overhung load

K : Load connection of gearhead shaft(Kg-cm)

T : Service factor(see Table 2)

f : Service factor(see table 2)

r : The diameter of gear or pully etc.

Table 2 Load connection factor

Connection method	Factor(K)
Chain sprocket	1
Gear, Pinion	1.25
V-belt	1.5
Flat-belt	2.5

The above listed ratings are the maximum permissible overhung and thrust loads.

Calculate the actual overhungload from the formular and then do not exceed the permissible loads to avoid a failure or a deformation of the shaft.

AC MOTOR & GEAR HEAD

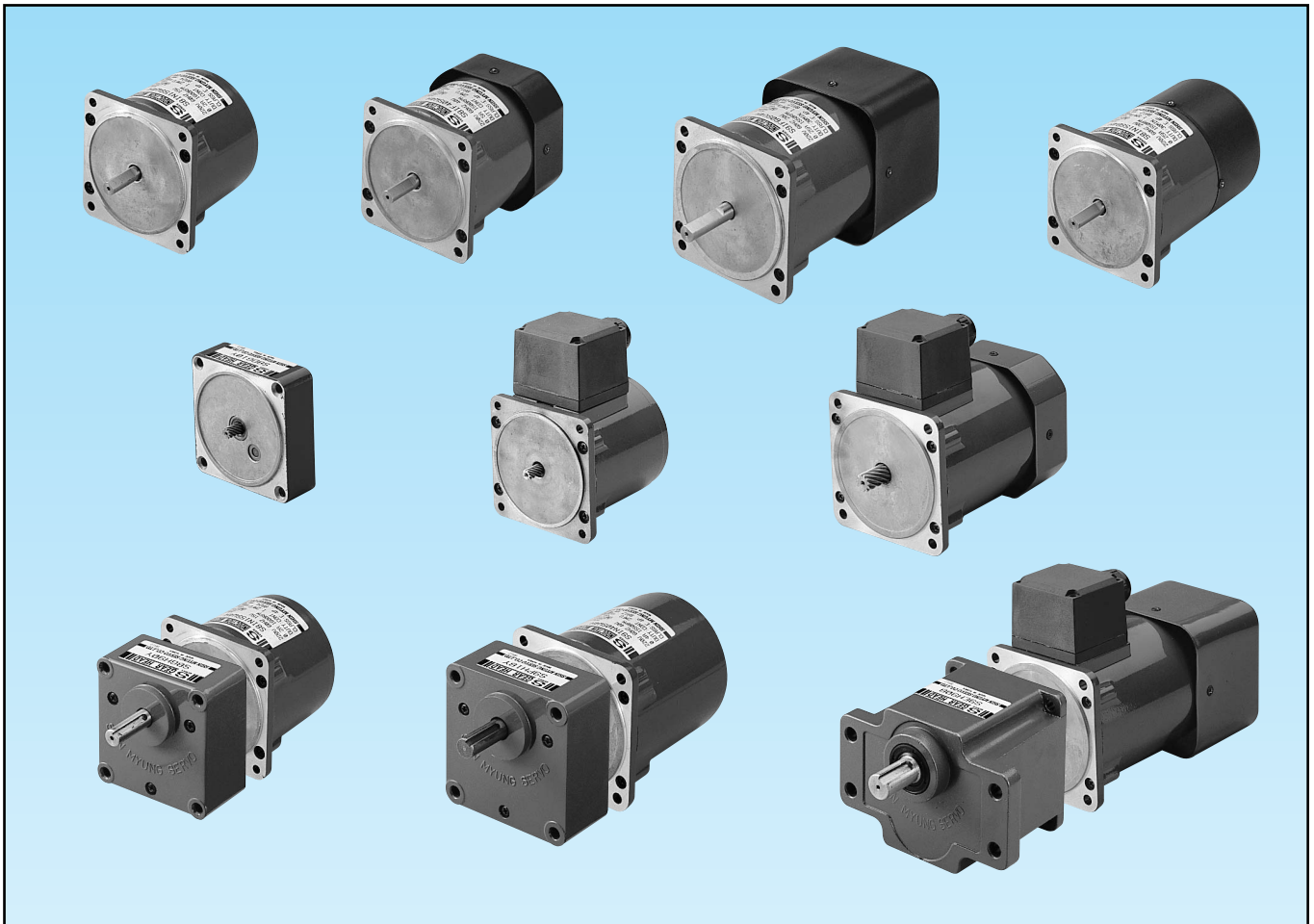

PRODUCTS

- | | |
|------------------------------------------------|----------|
| 1. INDUCTION MOTOR | 6W~120W |
| 2. REVERSIBLE MOTOR | 6W~120W |
| 3. SPEED CONTROL INDUCTION MOTOR & CONTROLLER | 15W~120W |
| 4. SPEED CONTROL REVERSIBLE MOTOR & CONTROLLER | 20W~120W |
| 5. MAGNETIC BRAKE INDUCTION MOTOR | 15W~120W |
| 6. MAGNETIC BRAKE REVERSIBLE MOTOR | 20W~120W |

INDUCTION MOTOR(C € approved)

6W

□60mm

LEAD WIRE TYPE

MOTOR DIMENSIONS

10



6IN6S4H(L)

WEIGHT 0.7kg

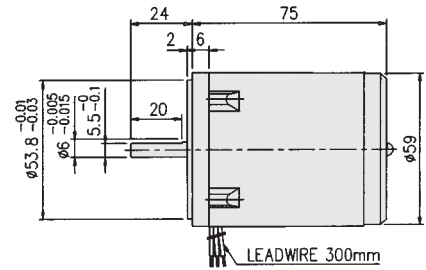
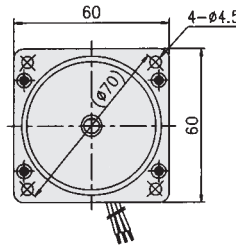

6IN6G4H(L)

WEIGHT 0.7kg

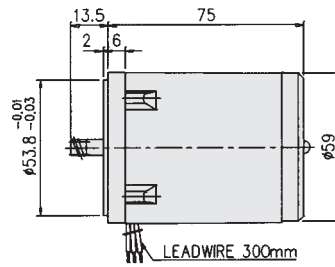
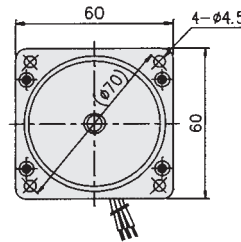

WIRING DIAGRAM

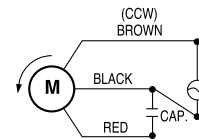
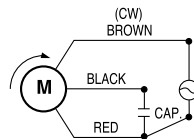

⊕ ELECTRICAL PERFORMANCES

- SINGLE PHASE, 4 POLES, CONTINUOUS DUTY, INSULATION CLASS "E"

MODEL		OUTPUT W	VOLTAGE V	FREQUENCY Hz	RATED					STARTING TORQUE		STARTING CURRENT mA	CAPACITOR μF
STRAIGHT SHAFT	PINION SHAFT				SPEED rpm	INPUT W	CURRENT mA	TORQUE		kg-cm	N-m		
6IN6S4L	6IN6G4L	6	100	50	1250	28	280	0.5	0.05	0.55	0.055	400	4
				60	1550	28	280	0.4	0.04	0.55	0.055	400	4
6IN6S4H	6IN6G4H	6	220	50	1250	40	180	0.5	0.05	0.55	0.055	220	0.8
				60	1550	40	180	0.4	0.04	0.55	0.055	220	0.8
6IN6S4C	6IN6G4C	6	220~240	50	1250	45	190	0.4	0.04	0.55	0.055	240	0.8

GEAR HEAD

MOTOR DIMENSIONS



GEARHEAD 6G□Y(B)

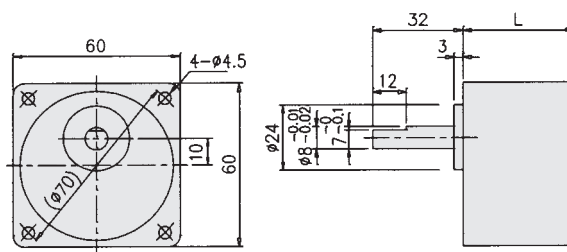

GEAR RATIO	L mm	WEIGHT(kg)	BOLT
1/3~1/18	30	0.25	M4×50
1/25~1/180	40	0.35	M4×60

DECIMAL GEARHEAD 6DG10Y(B)

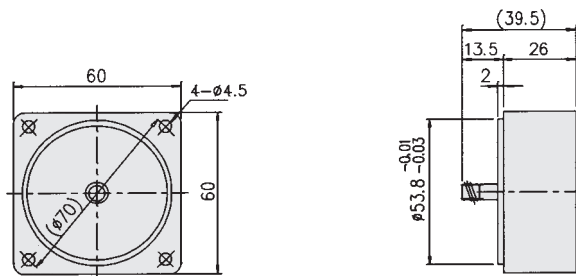

- ⊕ □ OF GEAR HEAD MODEL NAME INDICATE THE DEDUCTION RATIO.
- ⊕ THE NORMAL TORQUE(kg·cm) IS THAT THE MOTOR & GEAR HEAD ARE DIRECTLY COUPLED.
- ⊕ THE NORMAL TORQUE(kg·cm) IS 30kg·cm IN CASE THE DECIMAL GEARHEAD OF THE DEDUCTION RATIO 1/10 IS CONNECTED.
- ⊕ THE ROTATION DIRECTION OF OUTPUT SHAFT FOR THE GEARHEAD INDICATED ■ ROTATES WITH MOTOR ON THE CONTRARY.
- ⊕ THE ACTUAL ROTATION SPEED IS 2-20% LESS THAN SYNCHRONOUS SPEED ACCORDING TO THE SIZE OF THE LOAD.

50HZ

MODEL	rpm	500	416	300	250	200	166	120	100	83	75	60	50	42	30	25	20	16	15	12	10	8
	Ratio	3	3.6	5	6	7.5	9	12.5	15	18	20	25	30	36	50	60	75	90	100	120	150	180
6G□Y 6G□B	kg-cm	1.3	1.5	2.1	2.6	3.2	3.9	5.4	6.4	7.7	8.5	9.7	11.6	13.9	17.5	21.0	26.2	30	30	30	20	30
	N-m	0.13	0.15	0.21	0.26	0.31	0.38	0.53	0.63	0.75	0.83	0.95	1.14	1.36	1.72	2.06	2.57	2.94	2.94	2.94	2.94	2.94

60HZ

MODEL	rpm	600	500	360	300	240	200	144	120	100	90	72	60	50	36	30	24	20	18	15	12	10
	Ratio	3	3.6	5	6	7.5	9	12.5	15	18	20	25	30	36	50	60	75	90	100	120	150	180
6G□Y 6G□B	kg-cm	1.0	1.3	1.7	2.1	2.6	3.1	4.4	5.2	6.3	6.6	8.2	9.8	11.8	16.4	18.2	22.5	26.5	29.5	30	30	30
	N-m	0.10	0.13	0.17	0.21	0.25	0.30	0.43	0.51	0.62	0.65	0.84	0.96	1.16	1.60	1.78	2.20	2.59	2.89	2.94	2.94	2.94

INDUCTION MOTOR

MOTOR

N - T CURVE

MOTOR DIMENSIONS

PINION SHAFT

12

① **8IN15S4** □
8IN15GN4 □

WEIGHT 1.5kg

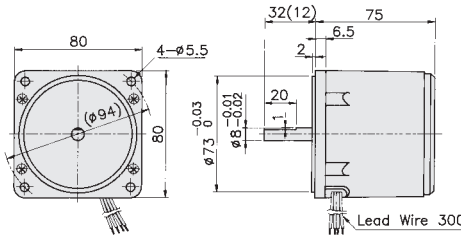
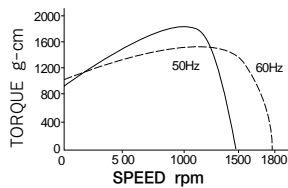

MODULE 0.5
PRESSURE ANGLE 20°
TEETH No. 10
DIAMETER ϕ 7.2mm
LENGTH 12mm

② **8IN25S4** □
8IN25GN4 □

WEIGHT 1.6kg

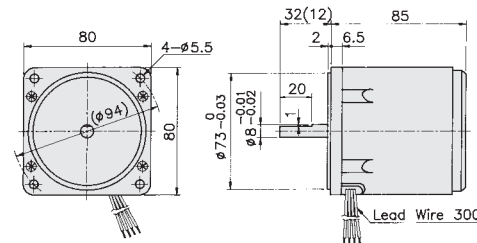
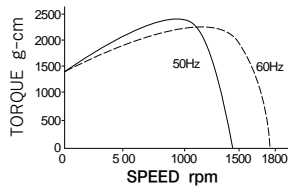

MODULE 0.5
PRESSURE ANGLE 20°
TEETH No. 10
DIAMETER ϕ 7.2mm
LENGTH 12mm

③ **8IF35S4** □
8IF35GN4 □

WEIGHT 1.7kg

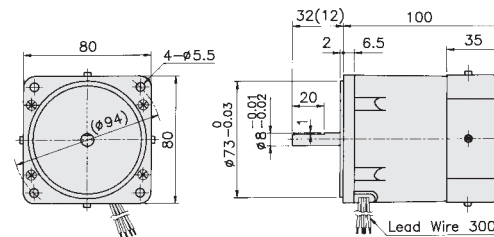
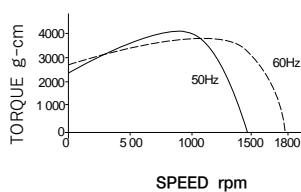

MODULE 0.5
PRESSURE ANGLE 20°
TEETH No. 10
DIAMETER ϕ 7.2mm
LENGTH 12mm

⚡ ELECTRICAL PERFORMANCES

- SINGLE PHASE, 4 POLES, CONTINUOUS DUTY, INSULATION CLASS "E"

FIG NO.	MODEL		OUTPUT W	VOLTAGE V	FREQUENCY Hz	RATED					STARTING TORQUE		STARTING CURRENT mA	CAPACITOR μ F
	STRAIGHT SHAFT	PINION SHAFT				SPEED rpm	INPUT W	CURRENT mA	TORQUE		kg-cm	N-m		
									kg-cm	N-m				
①	8IN15S4L	8IN15GN4L	15	100	50	1250	45	400	1.10	0.108	0.68	0.067	800	3
					60	1550	45	400	0.90	0.088	0.68	0.067	750	
①	8IN15S4H	8IN15GN4H	15	220	50	1250	45	200	1.10	0.108	0.68	0.067	400	1.2
					60	1550	45	200	0.90	0.088	0.68	0.067	400	
②	8IN25S4L	8IN25GN4L	25	100	50	1250	60	600	1.75	0.172	1.00	0.098	1100	6
					60	1550	60	600	1.40	0.137	1.00	0.098	1000	
②	8IN25S4H	8IN25GN4H	25	220	50	1250	60	290	1.75	0.172	1.00	0.098	500	1.5
					60	1550	60	290	1.40	0.137	1.00	0.098	500	
③	8IF35S4L	8IF35GN4L	35	100	50	1200	100	1000	3.10	0.304	1.90	0.186	1300	10
					60	1500	100	1000	2.60	0.255	1.90	0.186	1300	
③	8IF35S4H	8IF35GN4H	35	220	50	1200	100	500	3.10	0.304	1.90	0.186	650	2
					60	1500	100	500	2.60	0.255	1.90	0.186	650	

GEAR HEAD

DECIMAL GEAR HEAD (RATIO 1/10)

GEAR HEAD (RATIO 1/3~1/180)

② 8DGN10Y WEIGHT 0.3kg

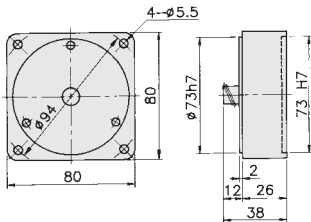

① 8GN□B
8GN□Y

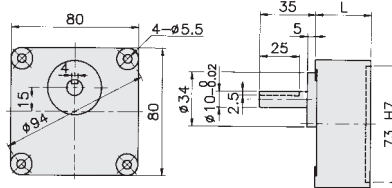

GEAR RATIO	L mm	WEIGHT(kg)	BOLT
1/3~1/18	30	0.5	M5×50
1/25~1/180	40	0.6	M5×60

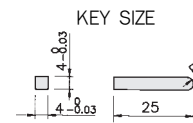

WIRING(SINGLE PHASE MOTOR)

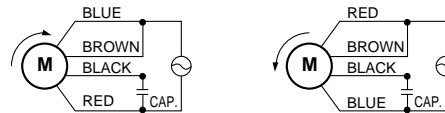

* Facing output shaft

- ⊕ THE NORMAL TORQUE(kg·cm) IS THAT THE MOTOR & GEAR HEAD ARE DIRECTLY COUPLED.
- ⊕ INSERT THE DENOMINATOR OF REDUTION RATIO IN □ OF GEAR HEAD MODEL NAME.
- ⊕ ACTUAL ROTATION SPEED IS 2-15% LESS THAN SYNCHRONOUS SPEED.

DECIMAL GEAR HEAD	GEAR HEAD MODEL	SYNCHRONOUS SPEED (RPM)																
		DENOMINATOR OF REDUCTION RATIO	500	300	200	120	100	60	50	30	20	15	10	6	5	3	2	1
			50Hz	3	5	7.5	12.5	15	25	30	50	75	100	150	250	300	500	750
② 8DGN10Y	① 8GN□Y, 8GN□B	60Hz	3.6	6	9	15	18	30	36	60	90	120	180	300	360	600	900	1800
② 8DGN10Y	① 8GN□Y, 8GN□B	50Hz	2.6	4.4	6.6	11	13	20	24	35	53	71	100	D35	D35	D65	D80	D100
② 8DGN10Y	① 8GN□Y, 8GN□B	60Hz	2.6	4.4	6.6	11	13	20	24	35	53	71	100	D35	D35	D65	D80	D100
② 8DGN10Y	① 8GN□Y, 8GN□B	50Hz	4.1	6.8	10	17	20	31	37	55	83	100	100	D35	D35	D65	D80	D100
② 8DGN10Y	① 8GN□Y, 8GN□B	60Hz	4.1	6.8	10	17	20	31	37	55	83	100	100	D35	D35	D65	D80	D100
② 8DGN10Y	① 8GN□Y, 8GN□B	50Hz	7.6	13	19	32	38	57	68	100	100	100	100	D35	D35	D65	D80	D100
② 8DGN10Y	① 8GN□Y, 8GN□B	60Hz	7.6	13	19	32	38	57	68	100	100	100	100	D35	D35	D65	D80	D100

■ COLOR INDICATES THAT THE ROTATION OF GEARHEAD SHAFT IS IN OPPOSITE DIRECTION AS OUTPUT SHAFT OF MOTOR
D:USE DECIMAL GEAR

INDUCTION MOTOR

MOTOR

N - T CURVE

MOTOR DIMENSIONS

PINION SHAFT

④ 9IN40S4 □ 9IN40P4 □

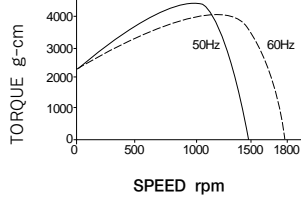

WEIGHT 2.5kg

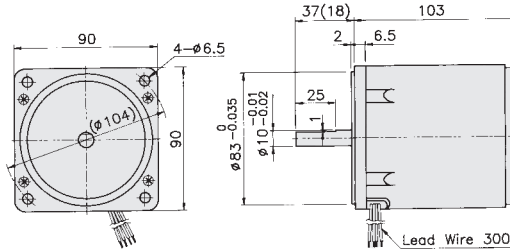

MODULE 0.6
PRESSURE ANGLE 20°
TEETH No. 12
DIAMETER ϕ 9.63mm
LENGTH 18mm

14

⑤ 9IF60S4 □ 9IF60P4 □

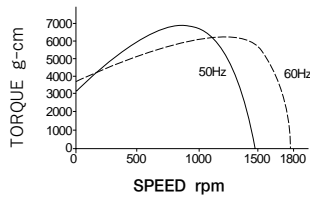

WEIGHT 2.6kg

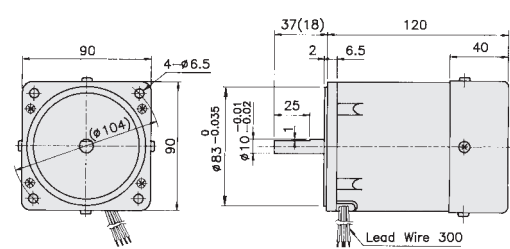

MODULE 0.6
PRESSURE ANGLE 20°
TEETH No. 12
DIAMETER ϕ 9.63mm
LENGTH 18mm

⑥ 9IF90S4 □ 9IF90E4 □

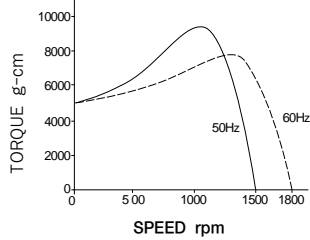

WEIGHT 3.2kg

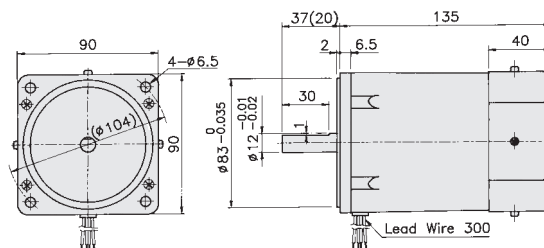

MODULE 0.8
PRESSURE ANGLE 20°
TEETH No. 11
DIAMETER ϕ 11.55mm
LENGTH 20mm

⑦ 9IF120S4 □ 9IF120E4 □

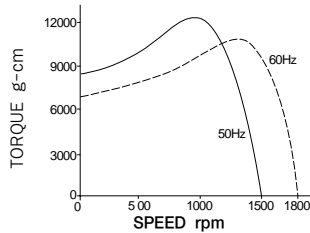

WEIGHT 3.2kg

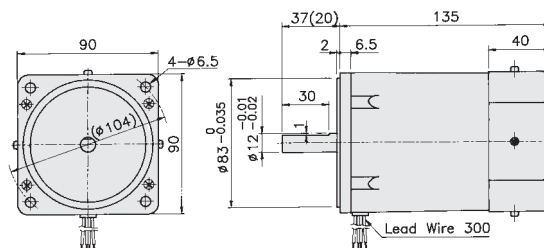

MODULE 0.8
PRESSURE ANGLE 20°
TEETH No. 11
DIAMETER ϕ 11.55mm
LENGTH 20mm

⊕ ELECTRICAL PERFORMANCES

- SINGLE PHASE, 4POLES, CONTINUOUS DUTY, INSULATION CLASS "E"

FIG NO.	MODEL		OUTPUT W	VOLTAGE V	FREQUENCY Hz	RATED					STARTING TORQUE		STARTING CURRENT mA	CAPACITOR μ F
	STRAIGHT SHAFT	PINION SHAFT				SPEED rpm	INPUT W	CURRENT mA	TORQUE		kg-cm	N-m		
									kg-cm	N-m				
④	9IN40S4L	9IN40P4L	40	100	50	1250	110	1100	3.00	0.294	1.80	0.176	1700	10
					60	1550	110	520	2.50	0.245	1.80	0.176	1600	
④	9IN40S4H	9IN40P4H	40	220	50	1250	110	520	3.00	0.294	1.80	0.176	1100	2
					60	1550	110	520	2.50	0.245	1.80	0.176	1100	
⑤	9IF60S4L	9IF60P4L	60	100	50	1250	150	1300	4.50	0.441	3.00	0.294	2200	16
					60	1550	150	1300	3.80	0.372	3.00	0.294	2200	
⑤	9IF60S4H	9IF60P4H	60	220	50	1250	150	700	4.50	0.441	3.00	0.294	1300	3.5
					60	1550	150	700	3.80	0.372	3.00	0.294	1300	
⑥	9IF90S4L	9IF90E4L	90	100	50	1250	200	2000	6.80	0.666	4.20	0.412	3200	25
					60	1550	200	2000	5.70	0.559	4.20	0.412	3000	
⑥	9IF90S4H	9IF90E4H	90	220	50	1250	200	1000	6.80	0.666	4.20	0.412	1600	5
					60	1550	200	1000	5.70	0.559	4.20	0.412	1500	
⑦	9IF120S4L	9IF120E4L	120	100	50	1350	240	2400	8.70	0.853	5.40	0.540	4800	35
					60	1600	240	2400	7.30	0.715	5.40	0.540	4600	
⑦	9IF120S4H	9IF120E4H	120	220	50	1350	350	1600	8.70	0.853	5.40	0.540	3200	6
					60	1600	350	1600	7.30	0.715	5.40	0.540	3200	

GEAR HEAD

DECIMAL GEAR HEAD (RATIO 1/10)

GEAR HEAD (RATIO 1/3~1/180)

④ 9DP10Y WEIGHT 0.6kg

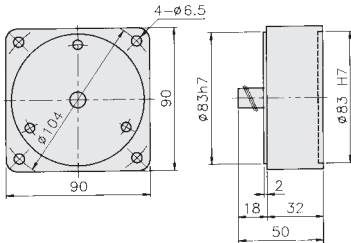

③ 9P□B
9P□Y

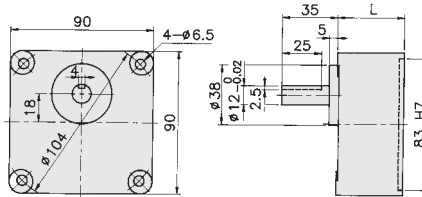

GEAR RATIO	L mm	WEIGHT(kg)	BOLT
1/3~1/18	42	0.8	M6×65
1/25~1/180	60	0.9	M6×80

KEY SIZE

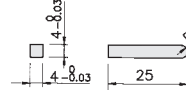

⑤ 9E□B

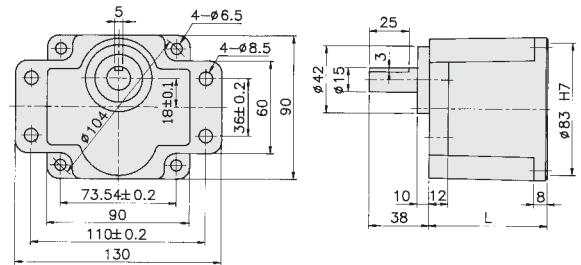

GEAR RATIO	L mm	WEIGHT(kg)	BOLT
1/3~1/60	65	1.6	M6×25
1/75~1/180	85	2.0	M6×25

KEY SIZE

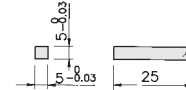

WIRING(SINGLE PHASE MOTOR)

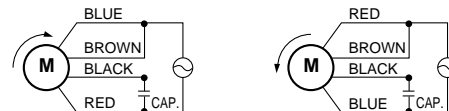

*Facing output shaft

- ⊕ THE NORMAL TORQUE(kg·cm) IS THAT THE MOTOR & GEAR HEAD ARE DIRECTLY COUPLED.
- ⊕ INSERT THE DENOMINATOR OF REDUTION RATIO IN □ OF GEAR HEAD MODEL NAME.
- ⊕ ACTUAL ROTATION SPEED IS 2-15% LESS THAN SYNCHRONOUS SPEED.

DECIMAL GEAR HEAD	GEAR HEAD MODEL	SYNCHRONOUS		500	300	200	120	100	60	50	30	20	15	10	6	5	3	2	1
		DENOMINATOR OF REDUCTION RATIO	50Hz	60Hz	3	5	7.5	12.5	15	25	30	50	75	100	150	250	300	500	750
④9DP10Y	③9P□Y, 9P□B		7.3	12	18	30	36	55	66	98	120	120	120	120	D 120	D 120	D 120	D 120	D 120
④9DP10Y	③9P□Y, 9P□B		7.3	12	18	30	36	55	66	98	120	120	120	120	D 120	D 120	D 120	D 120	D 120
④9DP10Y	③9P□Y, 9P□B		11	18	28	46	55	83	100	120	120	120	120	120	D 120	D 120	D 120	D 120	D 120
④9DP10Y	③9P□Y, 9P□B		11	18	28	46	55	83	100	120	120	120	120	120	D 120	D 120	D 120	D 120	D 120
—	⑤9E□B		17	28	42	62	75	112	135	224	300	300	300	300	-	-	-	-	-
—	⑤9E□B		17	28	42	62	75	112	135	224	300	300	300	300	-	-	-	-	-
—	⑤9E□B		21	35	53	80	96	144	172	287	300	300	300	300	-	-	-	-	-
—	⑤9E□B		21	35	53	80	96	144	172	287	300	300	300	300	-	-	-	-	-

■ COLOR INDICATES THAT THE ROTATION OF GEARHEAD SHAFT IS IN OPPOSITE DIRECTION AS OUTPUT SHAFT OF MOTOR
D:USE DECIMAL GEAR

INDUCTION MOTOR(C € approved)

MOTOR

N - T CURVE

MOTOR DIMENSIONS

PINION SHAFT

16

⑧ 8IN15S4C 8IN15GN4C

WEIGHT 1.5kg

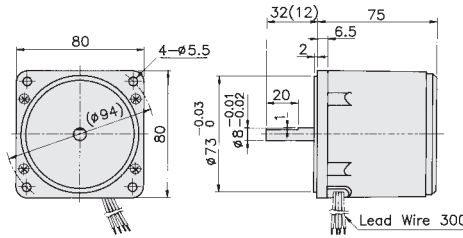
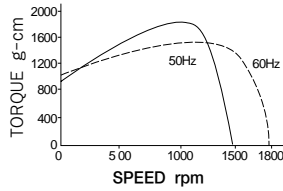

MODULE 0.5
PRESSURE ANGLE 20°
TEETH No. 10
DIAMETER ϕ 7.2mm
LENGTH 12mm

⑨ 8IN25S4C 8IN25GN4C

WEIGHT 1.6kg

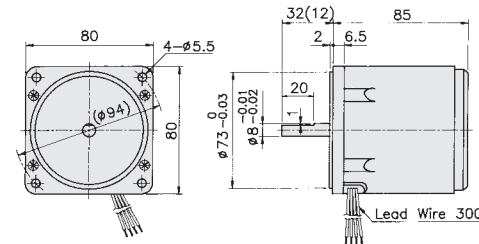
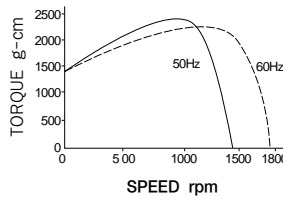

MODULE 0.5
PRESSURE ANGLE 20°
TEETH No. 10
DIAMETER ϕ 7.2mm
LENGTH 12mm

⑩ 8IF35S4C 8IF35GN4C

WEIGHT 1.7kg

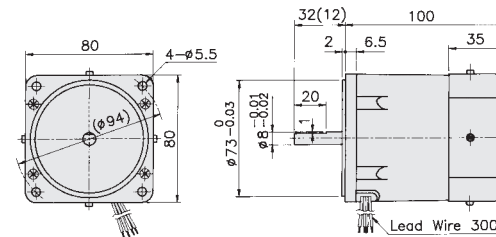
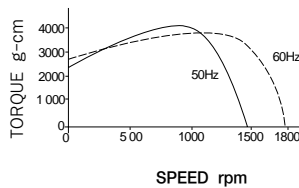

MODULE 0.5
PRESSURE ANGLE 20°
TEETH No. 10
DIAMETER ϕ 7.2mm
LENGTH 12mm

⊕ ELECTRICAL PERFORMANCES

- SINGLE PHASE, 4 POLES, CONTINUOUS DUTY, INSULATION CLASS "E"

FIG NO.	MODEL		OUTPUT W	VOLTAGE V	FREQUENCY Hz	RATED					STARTING TORQUE		STARTING CURRENT mA	CAPACITOR μ F
	STRAIGHT SHAFT	PINION SHAFT				SPEED rpm	INPUT W	CURRENT mA	TORQUE		kg-cm	N-m		
									kg-cm	N-m				
⑧	8IN15S4C	8IN15GN4C	15	220~240	50	1300	55	260	1.10	0.100	0.68	0.067	400	1.2
⑨	8IN25S4C	8IN25GN4C	25	220~240	50	1250	65	300	1.75	0.170	1.00	0.098	450	1.5
⑩	8IF35S4C	8IF35GN4C	35	220~240	50	1200	90	360	2.72	0.260	0.19	0.186	510	2.0

GEAR HEAD

DECIMAL GEAR HEAD

GEAR HEAD (RATIO 1/3~1/180)

2 8DGN10Y WEIGHT 0.3kg

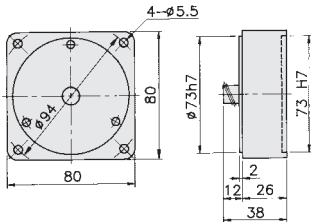

1 8GN□B
8GN□Y

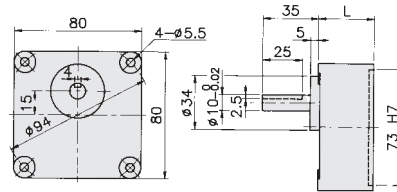

GEAR RATIO	L mm	WEIGHT(kg)	BOLT
1/3~1/18	30	0.5	M5×50
1/25~1/180	40	0.6	M5×60

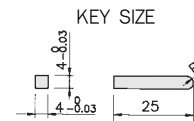

WIRING(SINGLE PHASE MOTOR)

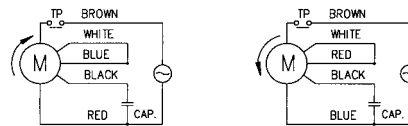

*Facing output shaft

- ⊕ THE NORMAL TORQUE(kg·cm) IS THAT THE MOTOR & GEAR HEAD ARE DIRECTLY COUPLED.
- ⊕ INSERT THE DENOMINATOR OF REDUTION RATIO IN □ OF GEAR HEAD MODEL NAME.
- ⊕ ACTUAL ROTATION SPEED IS 2-15% LESS THAN SYNCHRONOUS SPEED.

DECIMAL GEAR HEAD	GEAR HEAD MODEL	SYNCHRONOUS SPEED (RPM)																		
		DENOMINATOR OF REDUCTION RATIO	50Hz																	
			3	5	7.5	12.5	15	25	30	50	75	100	120	150	250	300	500	750	1500	
2 8DGN10Y	1 8GN□Y, 8GN□B	3.6	6	9	15	18	30	36	60	90	120	180	300	360	600	900	1800			
2 8DGN10Y	1 8GN□Y, 8GN□B	2.6	4.4	6.6	11	13	20	24	35	53	71	100	D35	D35	D65	D80	D100			
2 8DGN10Y	1 8GN□Y, 8GN□B	4.1	6.8	10	17	20	31	37	55	83	100	100	D35	D35	D65	D80	D100			
2 8DGN10Y	1 8GN□Y, 8GN□B	7.6	13	19	32	38	57	68	100	100	100	100	D35	D35	D65	D80	D100			

■ COLOR INDICATES THAT THE ROTATION OF GEARHEAD SHAFT IS IN OPPOSITE DIRECTION AS OUTPUT SHAFT OF MOTOR
D:USE DECIMAL GEAR

INDUCTION MOTOR(C € approved)

MOTOR

N - T CURVE

MOTOR DIMENSIONS

PINION SHAFT

⑪ 9IN40S4C 9IN40P4C

WEIGHT 2.5kg

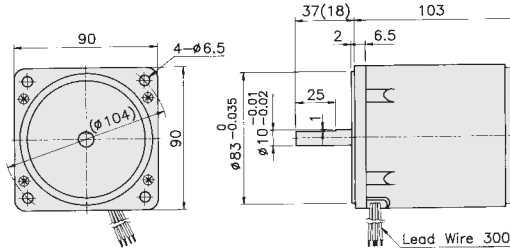
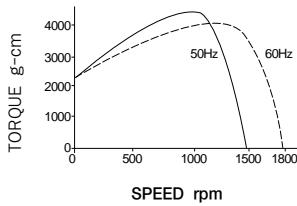

MODULE 0.6
PRESSURE ANGLE 20°
TEETH No. 12
DIAMETER ϕ 9.63mm
LENGTH 18mm

⑫ 9IF60S4C 9IF60P4C

WEIGHT 2.6kg

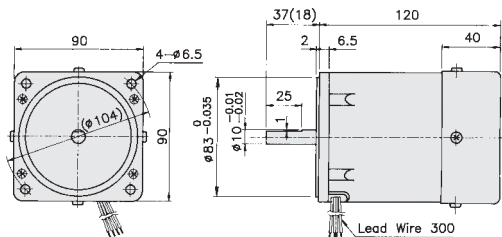
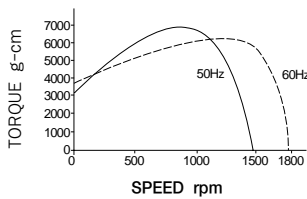

MODULE 0.6
PRESSURE ANGLE 20°
TEETH No. 12
DIAMETER ϕ 9.63mm
LENGTH 18mm

⑬ 9IF90S4C 9IF90E4C

WEIGHT 3.2kg

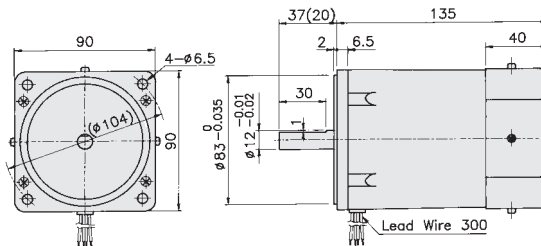
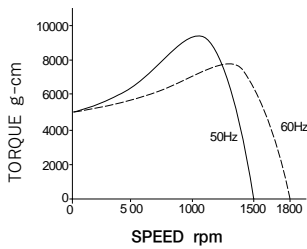

MODULE 0.8
PRESSURE ANGLE 20°
TEETH No. 11
DIAMETER ϕ 11.55mm
LENGTH 20mm

⑭ 9IF120S4C 9IF120E4C

WEIGHT 3.2kg

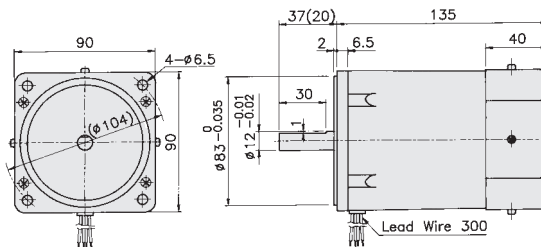
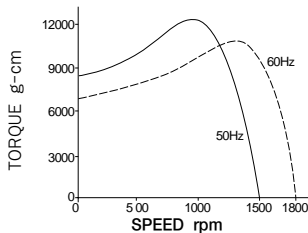

MODULE 0.8
PRESSURE ANGLE 20°
TEETH No. 11
DIAMETER ϕ 11.55mm
LENGTH 20mm

⊕ ELECTRICAL PERFORMANCES

- SINGLE PHASE, 4 POLES, CONTINUOUS DUTY, INSULATION CLASS "E"

FIG NO.	MODEL		OUTPUT W	VOLTAGE V	FREQUENCY Hz	RATED					STARTING TORQUE		STARTING CURRENT mA	CAPACITOR μ F
	STRAIGHT SHAFT	PINION SHAFT				SPEED rpm	INPUT W	CURRENT mA	TORQUE		kg-cm	N-m		
									kg-cm	N-m				
⑪	9IN40S4C	9IN40P4C	40	220~240	50	1300	100	490	3.00	0.294	1.79	0.176	900	2.0
⑫	9IF60S4C	9IF60P4C	60	220~240	50	1300	160	700	4.50	0.441	3.00	0.294	1140	3.5
⑬	9IF90S4C	9IF90E4C	90	220~240	50	1300	200	1000	6.79	0.666	4.19	0.411	1480	5.0
⑭	9IF120S4C	9IF120E4C	120	220~240	50	1250	400	1800	8.70	0.853	5.61	0.550	2800	7.0

GEAR HEAD

DECIMAL GEAR HEAD

GEAR HEAD (RATIO 1/3~1/180)

④ 9DP10Y WEIGHT 0.6kg

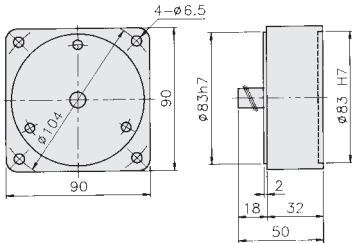

③ 9P□B
③ 9P□Y

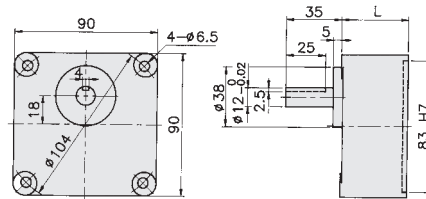

GEAR RATIO	L mm	WEIGHT(kg)	BOLT
1/3~1/18	42	0.8	M6×65
1/25~1/180	60	0.9	M6×80

KEY SIZE

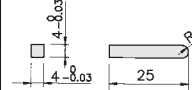

⑤ 9E□B

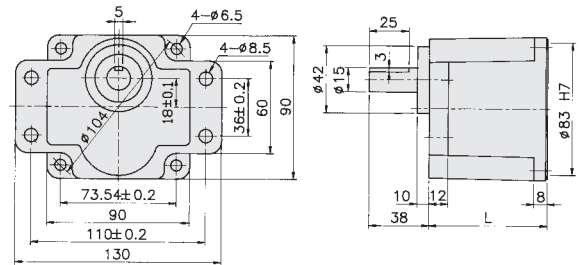

GEAR RATIO	L mm	WEIGHT(kg)	BOLT
1/3~1/60	65	1.6	M6×25
1/75~1/180	85	2.0	M6×25

KEY SIZE

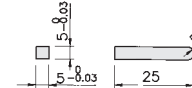

WIRING(SINGLE PHASE MOTOR)

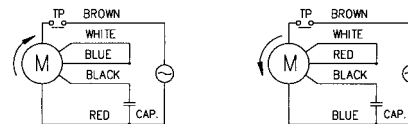

*Facing output shaft

- ⊕ THE NORMAL TORQUE(kg·cm) IS THAT THE MOTOR & GEAR HEAD ARE DIRECTLY COUPLED.
- ⊕ INSERT THE DENOMINATOR OF REDUTION RATIO IN □ OF GEAR HEAD MODEL NAME.
- ⊕ ACTUAL ROTATION SPEED IS 2-15% LESS THAN SYNCHRONOUS SPEED.

DECIMAL GEAR HEAD	GEAR HEAD MODEL	SYNCHRONOUS SPEED (RPM)																
		DENOMINATOR OF REDUCTION RATIO	50Hz		60Hz		50Hz		60Hz		50Hz		60Hz		50Hz		60Hz	
			3	5	7.5	12.5	15	25	30	50	75	100	150	200	300	450	600	
④9DP10Y	③9P□Y, 9P□B	7.3	12	18	30	36	55	66	98	120	120	120	D	D	D	D	D	
④9DP10Y	③9P□Y, 9P□B	11	18	28	46	55	83	100	120	120	120	120	D	D	D	D	D	
-	⑤9E□B	17	28	42	62	75	112	135	224	300	300	300	-	-	-	-	-	
-	⑤9E□B	21	35	53	80	96	144	172	287	300	300	300	-	-	-	-	-	

■ COLOR INDICATES THAT THE ROTATION OF GEARHEAD SHAFT IS IN OPPOSITE DIRECTION AS OUTPUT SHAFT OF MOTOR
D:USE DECIMAL GEAR

INDUCTION MOTOR(CE approved)

MOTOR

N - T CURVE

MOTOR DIMENSIONS

PINION SHAFT

20

15 8IN15S4C-T 8IN15GN4C-T

WEIGHT 1.7kg

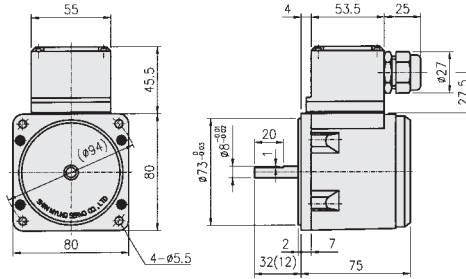
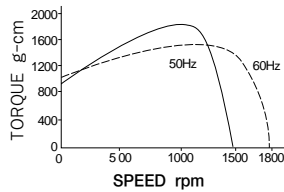

MODULE 0.5
PRESSURE ANGLE 20°
TEETH No. 10
DIAMETER ϕ 7.2mm
LENGTH 12mm

16 8IN25S4C-T 8IN25GN4C-T

WEIGHT 1.8kg

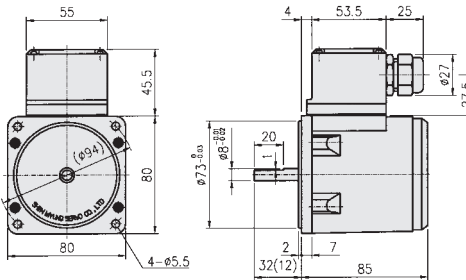
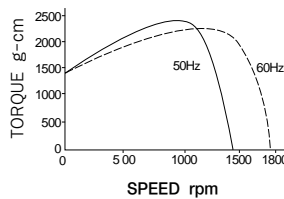

MODULE 0.5
PRESSURE ANGLE 20°
TEETH No. 10
DIAMETER ϕ 7.2mm
LENGTH 12mm

17 8IF35S4C-T 8IF35GN4C-T

WEIGHT 1.9kg

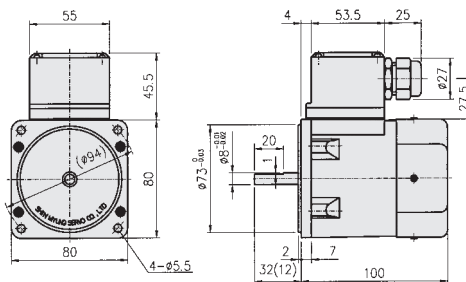
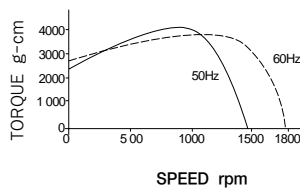

MODULE 0.5
PRESSURE ANGLE 20°
TEETH No. 10
DIAMETER ϕ 7.2mm
LENGTH 12mm

⊕ ELECTRICAL PERFORMANCES

- SINGLE PHASE, 4 POLES, CONTINUOUS DUTY, INSULATION CLASS "E"

FIG NO.	MODEL		OUTPUT W	VOLTAGE V	FREQUENCY Hz	RATED					STARTING TORQUE		STARTING CURRENT mA	CAPACITOR μ F
	STRAIGHT SHAFT	PINION SHAFT				SPEED rpm	INPUT W	CURRENT mA	TORQUE		kg-cm	N-m		
									kg-cm	N-m				
15	8IN15S4C-T	8IN15GN4C-T	15	220~240	50	1300	55	260	1.10	0.100	0.68	0.067	400	1.2
16	8IN25S4C-T	8IN25GN4C-T	25	220~240	50	1250	65	300	1.75	0.170	1.00	0.098	450	1.5
17	8IF35S4C-T	8IF35GN4C-T	35	220~240	50	1200	90	360	2.72	0.260	0.19	0.186	510	2.0

GEAR HEAD

DECIMAL GEAR HEAD (RATIO 1/10)

GEAR HEAD (RATIO 1/3~1/180)

2 8DGN10Y WEIGHT 0.3kg

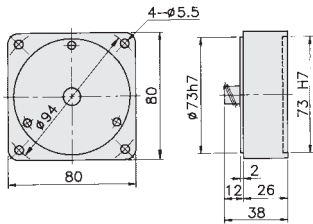

1 8GN□B
8GN□Y

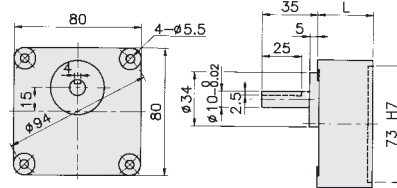

GEAR RATIO	L mm	WEIGHT(kg)	BOLT
1/3~1/18	30	0.5	M5×50
1/25~1/180	40	0.6	M5×60

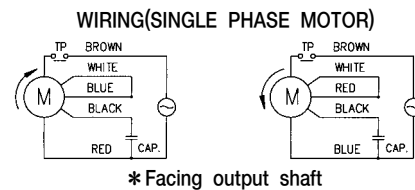
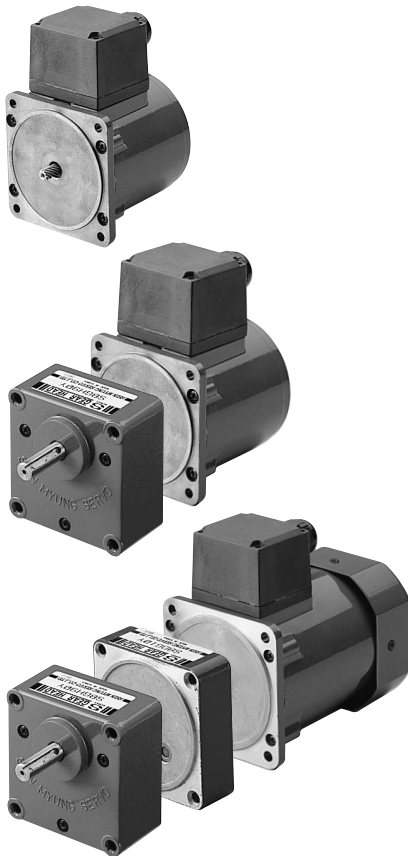
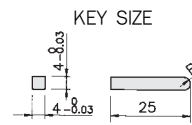

- ⊕ THE NORMAL TORQUE(kg·cm) IS THAT THE MOTOR & GEAR HEAD ARE DIRECTLY COUPLED.
- ⊕ INSERT THE DENOMINATOR OF REDUCTION RATIO IN □ OF GEAR HEAD MODEL NAME.
- ⊕ ACTUAL ROTATION SPEED IS 2-15% LESS THAN SYNCHRONOUS SPEED.

DECIMAL GEAR HEAD	GEAR HEAD MODEL	SYNCHRONOUS SPEED (RPM)																
		DENOMINATOR OF REDUCTION RATIO	500	300	200	120	100	60	50	30	20	15	10	6	5	3	2	1
			50Hz	3	5	7.5	12.5	15	25	30	50	75	100	150	250	300	500	750
28DGN10Y	18GN□Y, 8GN□B	60Hz	3.6	6	9	15	18	30	36	60	90	120	180	300	360	600	900	1800
28DGN10Y	18GN□Y, 8GN□B		2.6	4.4	6.6	11	13	20	24	35	53	71	100	D35	D35	D65	D80	D100
28DGN10Y	18GN□Y, 8GN□B		4.1	6.8	10	17	20	31	37	55	83	100	100	D35	D35	D65	D80	D100
28DGN10Y	18GN□Y, 8GN□B		7.6	13	19	32	38	57	68	100	100	100	100	D35	D35	D65	D80	D100

■ COLOR INDICATES THAT THE ROTATION OF GEARHEAD SHAFT IS IN OPPOSITE DIRECTION AS OUTPUT SHAFT OF MOTOR
D:USE DECIMAL GEAR

INDUCTION MOTOR(CE approved)

MOTOR

N - T CURVE

MOTOR DIMENSIONS

PINION SHAFT

18 9IN40S4C-T
9IN40P4C-T

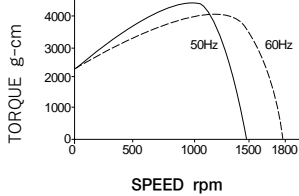

WEIGHT 2.7kg

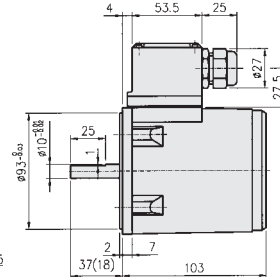
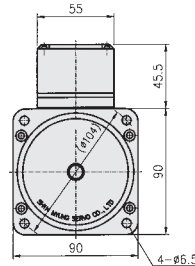

MODULE 0.6
PRESSURE ANGLE 20°
TEETH No. 12
DIAMETER ϕ 9.63mm
LENGTH 18mm

19 9IF60S4C-T
9IF60P4C-T

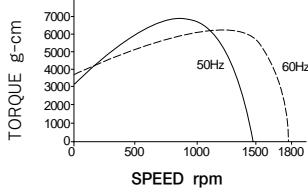

WEIGHT 2.8kg

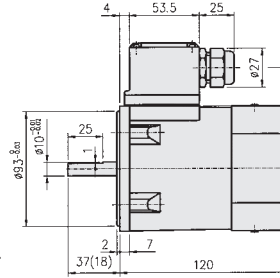
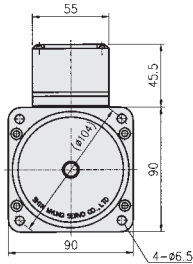

MODULE 0.6
PRESSURE ANGLE 20°
TEETH No. 12
DIAMETER ϕ 9.63mm
LENGTH 18mm

20 9IF90S4C-T
9IF90E4C-T

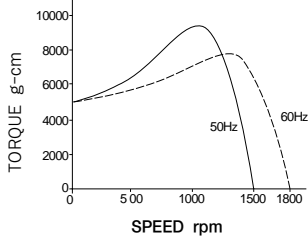

WEIGHT 3.4kg

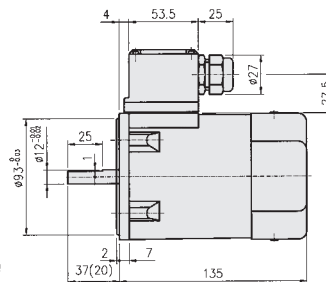
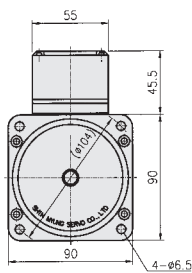

MODULE 0.8
PRESSURE ANGLE 20°
TEETH No. 11
DIAMETER ϕ 11.55mm
LENGTH 20mm

21 9IF120S4C-T
9IF120E4C-T

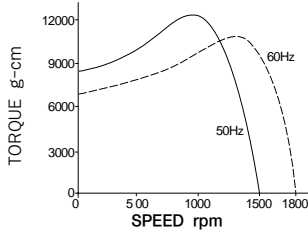

WEIGHT 3.4kg

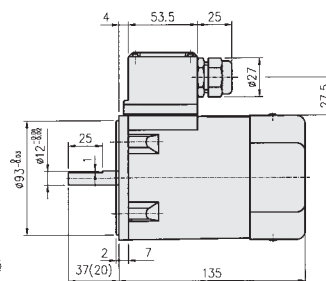
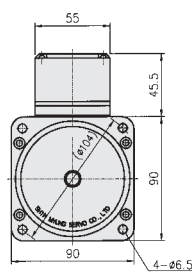

MODULE 0.8
PRESSURE ANGLE 20°
TEETH No. 11
DIAMETER ϕ 11.55mm
LENGTH 20mm

⊕ ELECTRICAL PERFORMANCES

- SINGLE PHASE, 4 POLES, CONTINUOUS DUTY, INSULATION CLASS "E"

FIG NO.	MODEL		OUTPUT W	VOLTAGE V	FREQUENCY Hz	RATED					STARTING TORQUE		STARTING CURRENT mA	CAPACITOR μ F
	STRAIGHT SHAFT	PINION SHAFT				SPEED rpm	INPUT W	CURRENT mA	TORQUE		kg-cm	N-m		
									kg-cm	N-m				
18	9IN40S4C-T	9IN40P4C-T	40	220~240	50	1300	100	490	3.00	0.294	1.79	0.176	900	2.0
19	9IF60S4C-T	9IF60P4C-T	60	220~240	50	1300	160	700	4.50	0.441	3.00	0.294	1140	3.5
20	9IF90S4C-T	9IF90E4C-T	90	220~240	50	1300	200	1000	6.79	0.666	4.19	0.411	1480	5.0
21	9IF120S4C-T	9IF120E4C-T	120	220~240	50	1250	400	1800	8.70	0.853	5.61	0.550	2800	7.0

GEAR HEAD

DECIMAL GEAR HEAD (RATIO 1/10)

GEAR HEAD (RATIO 1/3~1/180)

④ 9DP10Y WEIGHT 0.6kg

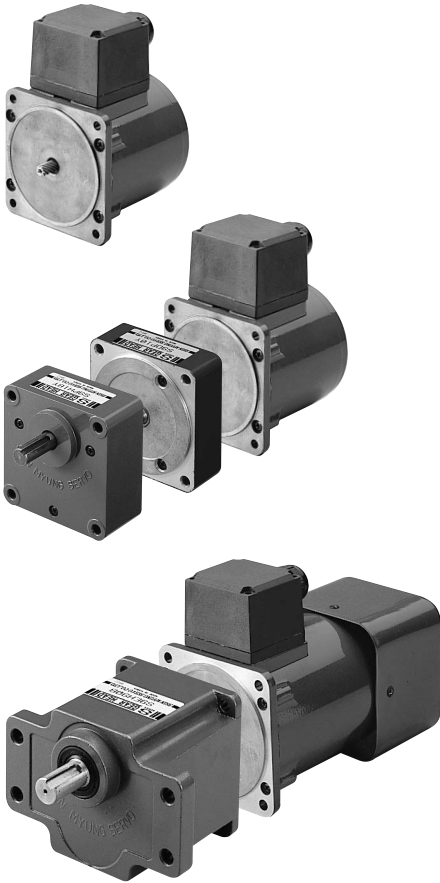
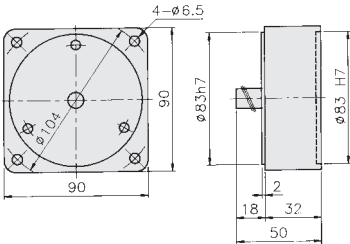

③ 9P□B
9P□Y

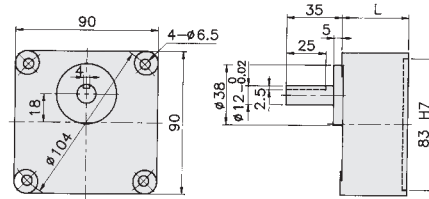

GEAR RATIO	L mm	WEIGHT(kg)	BOLT
1/3~1/18	42	0.8	M6×65
1/25~1/180	60	0.9	M6×80

KEY SIZE

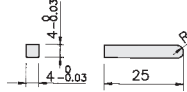

⑤ 9E□B

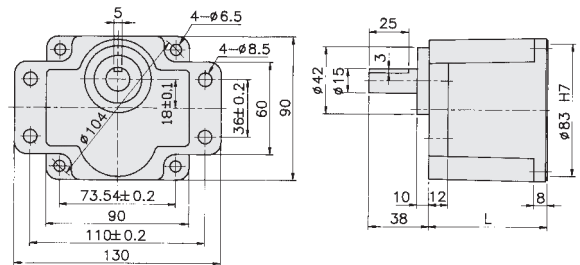

GEAR RATIO	L mm	WEIGHT(kg)	BOLT
1/3~1/60	65	1.6	M6×25
1/75~1/180	85	2.0	M6×25

KEY SIZE

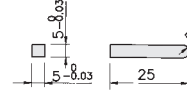

WIRING(SINGLE PHASE MOTOR)

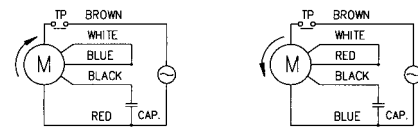

* Facing output shaft

- ⊕ THE NORMAL TORQUE(kg·cm) IS THAT THE MOTOR & GEAR HEAD ARE DIRECTLY COUPLED.
- ⊕ INSERT THE DENOMINATOR OF REDUTION RATIO IN □ OF GEAR HEAD MODEL NAME.
- ⊕ ACTUAL ROTATION SPEED IS 2-15% LESS THAN SYNCHRONOUS SPEED.

DECIMAL GEAR HEAD	GEAR HEAD MODEL	SYNCHRONOUS SPEED (RPM)		500	300	200	120	100	60	50	30	20	15	10	6	5	3	2	1
		DENOMINATOR OF REDUCTION RATIO	50Hz	3	5	7.5	12.5	15	25	30	50	75	100	150	250	300	500	750	1500
			60Hz	3.6	6	9	15	18	30	36	60	90	120	180	300	360	600	900	1800
④9DP10Y	③9P□Y, 9P□B		7.3	12	18	30	36	55	66	98	120	120	120	D 120	D 120	D 120	D 120	D 120	D 120
④9DP10Y	③9P□Y, 9P□B		11	18	28	46	55	83	100	120	120	120	120	D 120	D 120	D 120	D 120	D 120	D 120
-	⑤9E□B		17	28	42	62	75	112	135	224	300	300	300	-	-	-	-	-	-
-	⑤9E□B		21	35	53	80	96	144	172	287	300	300	300	-	-	-	-	-	-

■ COLOR INDICATES THAT THE ROTATION OF GEARHEAD SHAFT IS IN OPPOSITE DIRECTION AS OUTPUT SHAFT OF MOTOR
D:USE DECIMAL GEAR

INDUCTION MOTOR (us approved)

MOTOR

N - T CURVE

MOTOR DIMENSIONS

PINION SHAFT

24

② 8IN15S4U 8IN15GN4U

WEIGHT 1.5kg

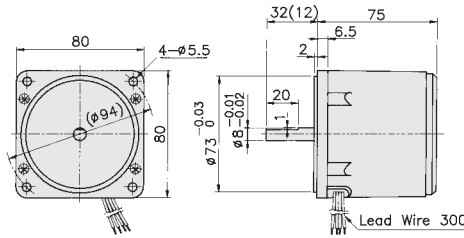
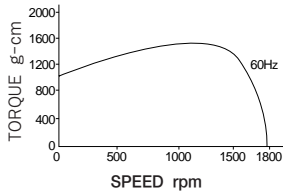

MODULE 0.5
PRESSURE ANGLE 20°
TEETH No. 10
DIAMETER φ 7.2mm
LENGTH 12mm

③ 8IN25S4U 8IN25GN4U

WEIGHT 1.6kg

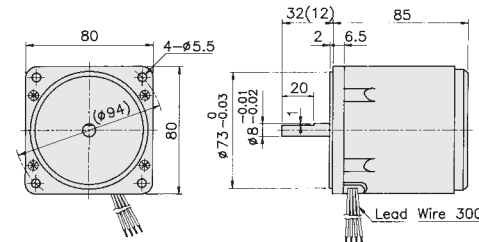
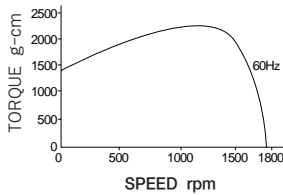

MODULE 0.5
PRESSURE ANGLE 20°
TEETH No. 10
DIAMETER φ 7.2mm
LENGTH 12mm

⊕ ELECTRICAL PERFORMANCES

- SINGLE PHASE, 4 POLES, CONTINUOUS DUTY, INSULATION CLASS "A"

FIG NO.	MODEL		OUTPUT W	VOLTAGE V	FREQUENCY Hz	RATED				STARTING TORQUE		STARTING CURRENT mA	CAPACITOR μF	
	STRAIGHT SHAFT	PINION SHAFT				SPEED rpm	INPUT W	CURRENT mA	TORQUE		kg-cm			N-m
									kg-cm	N-m				
②	8IN15S4U	8IN15GN4U	15	115	60	1600	46	400	0.90	0.088	0.68	0.067	750	2.0
③	8IN25S4U	8IN25GN4U	25	115	60	1550	69	600	1.4	0.137	1.0	0.098	1000	4.0

GEAR HEAD

DECIMAL GEAR HEAD (RATIO 1/10)

GEAR HEAD (RATIO 1/3~1/180)

② 8DGN10Y WEIGHT 0.3kg

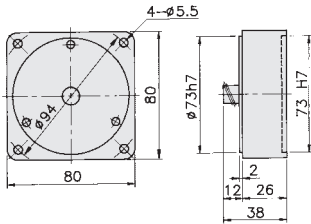

① 8GN□B
8GN□Y

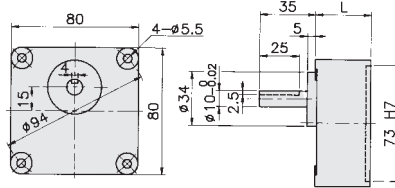

GEAR RATIO	L mm	WEIGHT(kg)	BOLT
1/3~1/18	30	0.5	M5×50
1/25~1/180	40	0.6	M5×60

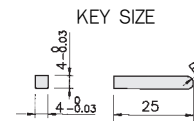

WIRING(SINGLE PHASE MOTOR)

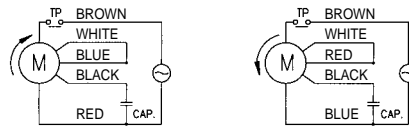

*Facing output shaft

- ⊕ THE NORMAL TORQUE(kg·cm) IS THAT THE MOTOR & GEAR HEAD ARE DIRECTLY COUPLED.
- ⊕ INSERT THE DENOMINATOR OF REDUCTION RATIO IN □ OF GEAR HEAD MODEL NAME.
- ⊕ ACTUAL ROTATION SPEED IS 2-15% LESS THAN SYNCHRONOUS SPEED.

DECIMAL GEAR HEAD	GEAR HEAD MODEL	SYNCHRONOUS SPEED (RPM)														
		600	360	240	144	100	60	36	24	18	12	7.2	5	3	2	1
		DENOMINATOR OF REDUCTION RATIO (60Hz)														
②8DGN10Y	①8GN□Y, 8GN□B	3	5	7.5	12.5	18	30	50	75	100	150	250	360	600	900	1800
		3.6	6	9	15	25	36	60	90	120	180	300	500	750	1500	
②8DGN10Y	①8GN□Y, 8GN□B	2	3	5	9	13	16	29	44	59	88	D35	D35	D65	D80	D100
		2	4	6	10	16	19	35	53	70	100	D35	D65	D80	D100	
②8DGN10Y	①8GN□Y, 8GN□B	3	5	8	14	20	30	45	68	91	100	D35	D35	D65	D80	D100
		4	6	10	17	25	36	55	82	100	100	D35	D65	D80	D100	

■ COLOR INDICATES THAT THE ROTATION OF GEARHEAD SHAFT IS IN OPPOSITE DIRECTION AS OUTPUT SHAFT OF MOTOR
D:USE DECIMAL GEAR

INDUCTION MOTOR (us approved)

MOTOR

N - T CURVE

MOTOR DIMENSIONS

PINION SHAFT

②④ 9IN40S4U 9IN40P4U

WEIGHT 2.5kg

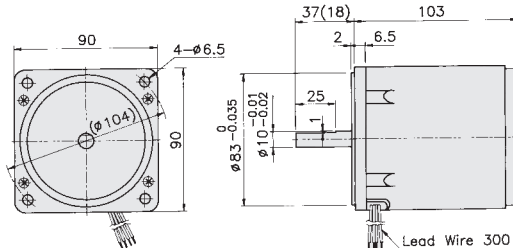
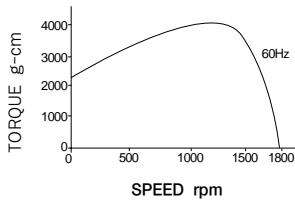

MODULE 0.6
PRESSURE ANGLE 20°
TEETH No. 12
DIAMETER ϕ 9.63mm
LENGTH 18mm

26

②⑤ 9IF60S4U 9IF60P4U

WEIGHT 2.6kg

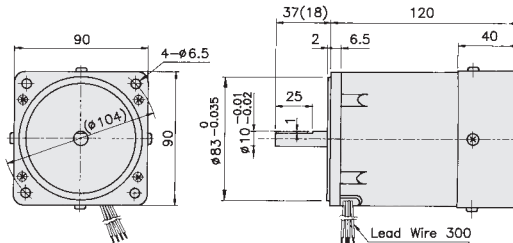
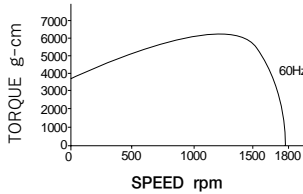

MODULE 0.6
PRESSURE ANGLE 20°
TEETH No. 12
DIAMETER ϕ 9.63mm
LENGTH 18mm

②⑥ 9IF90S4U 9IF90E4U

WEIGHT 3.2kg

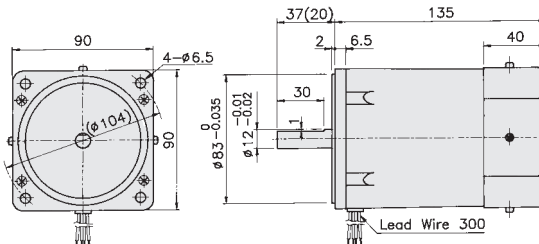
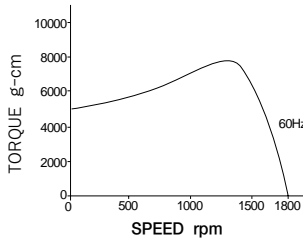

MODULE 0.8
PRESSURE ANGLE 20°
TEETH No. 11
DIAMETER ϕ 11.55mm
LENGTH 20mm

⊕ ELECTRICAL PERFORMANCES

- SINGLE PHASE, 4 POLES, CONTINUOUS DUTY, INSULATION CLASS "A"

FIG NO.	MODEL		OUTPUT W	VOLTAGE V	FREQUENCY Hz	RATED					STARTING TORQUE		STARTING CURRENT mA	CAPACITOR μ F
	STRAIGHT SHAFT	PINION SHAFT				SPEED rpm	INPUT W	CURRENT mA	TORQUE		kg-cm	N-m		
									kg-cm	N-m				
②④	9IN40S4U	9IN40P4U	40	115	60	1600	97	850	2.5	0.245	1.8	1.176	1600	8.0
②⑤	9IF60S4U	9IF60P4U	60	115	60	1600	149	1300	3.8	0.372	3.0	0.294	2200	12.0
②⑥	9IF90S4U	9IF90E4U	90	115	60	1600	230	2000	5.7	0.559	4.2	0.412	3000	20.0

GEAR HEAD

DECIMAL GEAR HEAD (RATIO 1/10)

GEAR HEAD (RATIO 1/3~1/180)

④ 9DP10Y WEIGHT 0.6kg

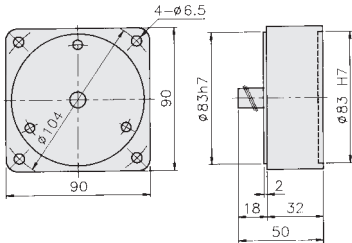

③ 9P□B
9P□Y

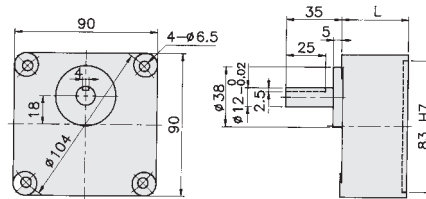

GEAR RATIO	L mm	WEIGHT(kg)	BOLT
1/3~1/18	42	0.8	M6×65
1/25~1/180	60	0.9	M6×80

KEY SIZE

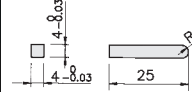

⑤ 9E□B

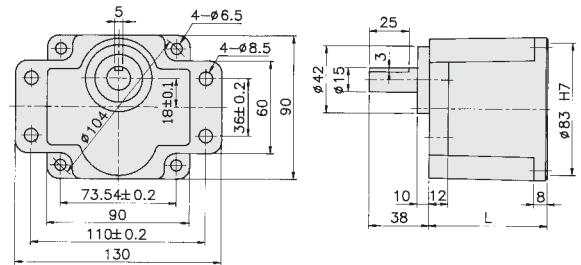

GEAR RATIO	L mm	WEIGHT(kg)	BOLT
1/3~1/60	65	1.6	M6×25
1/75~1/180	85	2.0	M6×25

KEY SIZE

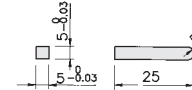

WIRING(SINGLE PHASE MOTOR)

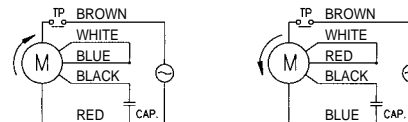

*Facing output shaft

- ⊕ THE NORMAL TORQUE(kg·cm) IS THAT THE MOTOR & GEAR HEAD ARE DIRECTLY COUPLED.
- ⊕ INSERT THE DENOMINATOR OF REDUCTION RATIO IN □ OF GEAR HEAD MODEL NAME.
- ⊕ ACTUAL ROTATION SPEED IS 2-15% LESS THAN SYNCHRONOUS SPEED.

DECIMAL GEAR HEAD	GEAR HEAD MODEL	SYNCHRONOUS SPEED (RPM)															
		600	360	240	144	100	60	36	24	18	12	7.2	5	3	2	1	
④9DP10Y	③9P□Y, 9P□B	500	300	200	120	72	50	30	20	15	10	6	3.6	2.4	1.2		
		3	5	7.5	12.5	18	30	50	75	100	150	250	360	600	900	1800	
④9DP10Y	③9P□Y, 9P□B	3.6	6	9	15	25	36	60	90	120	180	300	500	750	1500		
		6	10	15	25	36	54	82	120	120	120	D120	D120	D120	D120	D120	
④9DP10Y	③9P□Y, 9P□B	7	12	18	30	45	65	98	120	120	120	D120	D120	D120	D120		
		9	15	23	38	55	83	120	120	120	120	D120	D120	D120	D120	D120	
-	⑤9E□B	11	18	27	46	69	99	120	120	120	120	D120	D120	D120	D120		
		13	23	34	57	83	124	186	280	300	300						
-	⑤9E□B	16	27	41	69	103	149	224	300	300	300						

■ COLOR INDICATES THAT THE ROTATION OF GEARHEAD SHAFT IS IN OPPOSITE DIRECTION AS OUTPUT SHAFT OF MOTOR
D:USE DECIMAL GEAR

INDUCTION MOTOR (us approved)

MOTOR

N - T CURVE

MOTOR DIMENSIONS

PINION SHAFT

28

⑰ 8IN15S4U -T 8IN15GN4U -T

WEIGHT 1.7kg

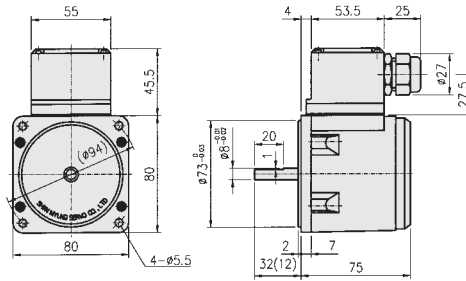
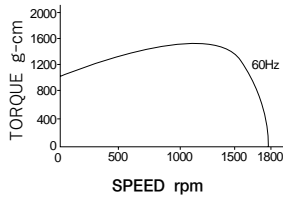

MODULE 0.5
PRESSURE ANGLE 20°
TEETH No. 10
DIAMETER ϕ 7.2mm
LENGTH 12mm

⑱ 8IN25S4U -T 8IN25GN4U -T

WEIGHT 1.8kg

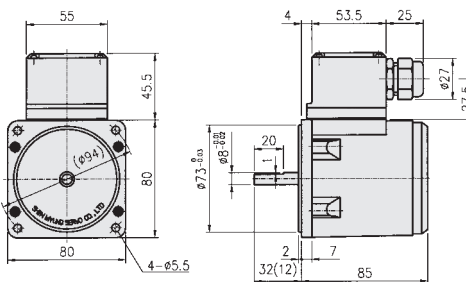
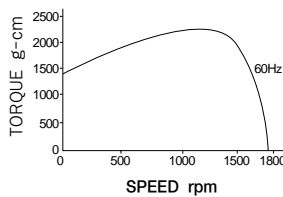

MODULE 0.5
PRESSURE ANGLE 20°
TEETH No. 10
DIAMETER ϕ 7.2mm
LENGTH 12mm

◆ ELECTRICAL PERFORMANCES
- SINGLE PHASE, 4 POLES, CONTINUOUS DUTY, INSULATION CLASS "A"

FIG NO.	MODEL		OUTPUT W	VOLTAGE V	FREQUENCY Hz	RATED					STARTING TORQUE		STARTING CURRENT mA	CAPACITOR μ F
	STRAIGHT SHAFT	PINION SHAFT				SPEED rpm	INPUT W	CURRENT mA	TORQUE		kg-cm	N-m		
									kg-cm	N-m				
⑰	8IN15S4U-T	8IN15GN4U-T	15	115	60	1600	46	400	0.9	0.088	0.68	0.067	750	2.0
⑱	8IN25S4U-T	8IN25GN4U-T	25	115	60	1550	69	600	1.4	0.137	1.0	0.098	1000	4.0

GEAR HEAD

DECIMAL GEAR HEAD (RATIO 1/10)

GEAR HEAD (RATIO 1/3~1/180)

2 8DGN10Y WEIGHT 0.3kg

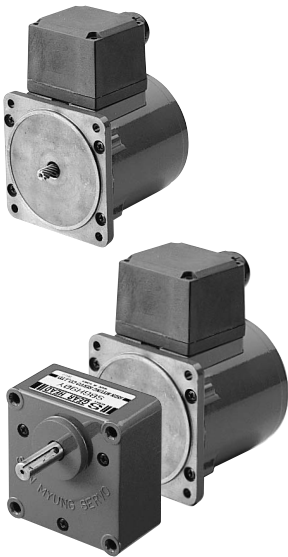
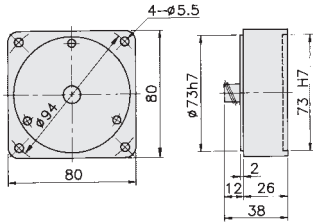

1 8GN□B
8GN□Y

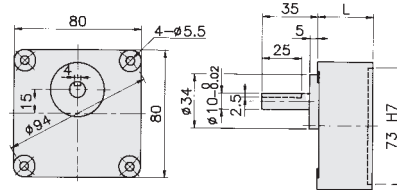

GEAR RATIO	L mm	WEIGHT(kg)	BOLT
1/3~1/18	30	0.5	M5×50
1/25~1/180	40	0.6	M5×60

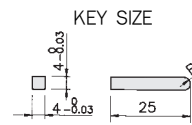

WIRING(SINGLE PHASE MOTOR)

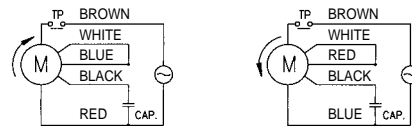

*Facing output shaft

- ⊕ THE NORMAL TORQUE(kg·cm) IS THAT THE MOTOR & GEAR HEAD ARE DIRECTLY COUPLED.
- ⊕ INSERT THE DENOMINATOR OF REDUTION RATIO IN □ OF GEAR HEAD MODEL NAME.
- ⊕ ACTUAL ROTATION SPEED IS 2-15% LESS THAN SYNCHRONOUS SPEED.

DECIMAL GEAR HEAD	GEAR HEAD MODEL	SYNCHRONOUS SPEED (RPM)	600	360	240	144	100	60	36	24	18	12	7.2	5	3	2	1	
			DENOMINATOR OF REDUCTION RATIO (60Hz)	3	5	7.5	12.5	18	30	50	75	100	150	250	360	600	900	1800
2 8DGN10Y	1 8GN□Y, 8GN□B	3.6	6	9	15	25	36	60	90	120	180	300	500	750	1500			
		2	3	5	9	13	16	29	44	59	88	D35	D35	D65	D80	D100		
2 8DGN10Y	1 8GN□Y, 8GN□B	3	5	8	14	20	30	45	68	91	100	D35	D35	D65	D80	D100		
		4	6	10	17	25	36	55	82	100	100	D35	D65	D80	D100			

■ COLOR INDICATES THAT THE ROTATION OF GEARHEAD SHAFT IS IN OPPOSITE DIRECTION AS OUTPUT SHAFT OF MOTOR
D:USE DECIMAL GEAR

INDUCTION MOTOR (us approved)

MOTOR

N - T CURVE

MOTOR DIMENSIONS

PINION SHAFT

30

② 9IN40S4U -T
9IN40P4U -T

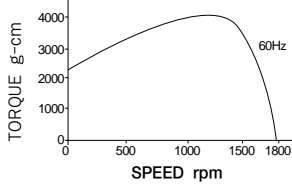

WEIGHT 2.7kg

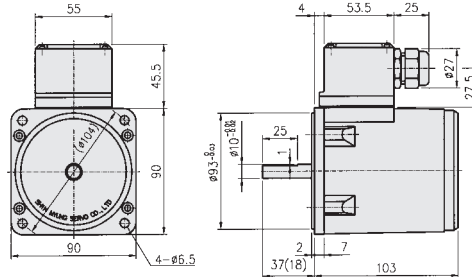

MODULE 0.6
PRESSURE ANGLE 20°
TEETH No. 12
DIAMETER ø9.63mm
LENGTH 18mm

③ 9IF60S4U -T
9IF60P4U -T

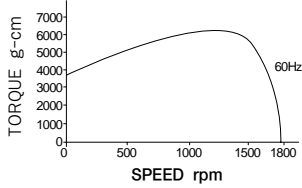

WEIGHT 2.8kg

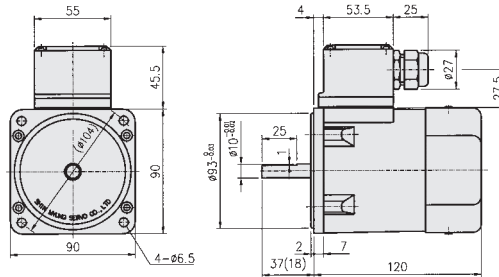

MODULE 0.6
PRESSURE ANGLE 20°
TEETH No. 12
DIAMETER ø9.63mm
LENGTH 18mm

④ 9IF90S4U -T
9IF90E4U -T

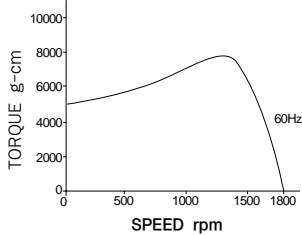

WEIGHT 3.4kg

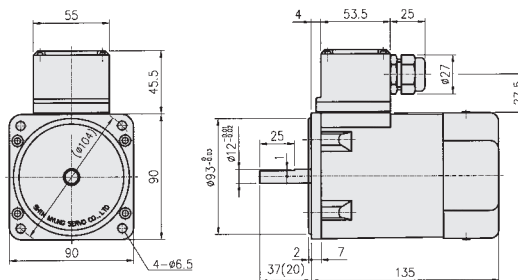

MODULE 0.8
PRESSURE ANGLE 20°
TEETH No. 11
DIAMETER ø11.55mm
LENGTH 20mm

⊕ ELECTRICAL PERFORMANCES

- SINGLE PHASE, 4 POLES, CONTINUOUS DUTY, INSULATION CLASS "A"

FIG NO.	MODEL		OUTPUT W	VOLTAGE V	FREQUENCY Hz	RATED					STARTING TORQUE		STARTING CURRENT mA	CAPACITOR μF
	STRAIGHT SHAFT	PINION SHAFT				SPEED rpm	INPUT W	CURRENT mA	TORQUE		kg-cm	N-m		
									kg-cm	N-m				
②	9IN40S4U-T	9IN40P4U-T	40	115	60	1600	97	850	2.5	0.245	1.8	1.176	1600	8.0
③	9IF60S4U-T	9IF60P4U-T	60	115	60	1600	149	1300	3.8	0.372	3.0	0.294	2200	12.0
④	9IF90S4U-T	9IF90E4U-T	90	115	60	1600	230	2000	5.7	0.559	4.2	0.412	3000	20.0

GEAR HEAD

DECIMAL GEAR HEAD (RATIO 1/10)

GEAR HEAD (RATIO 1/3~1/180)

④ 9DP10Y WEIGHT 0.6kg

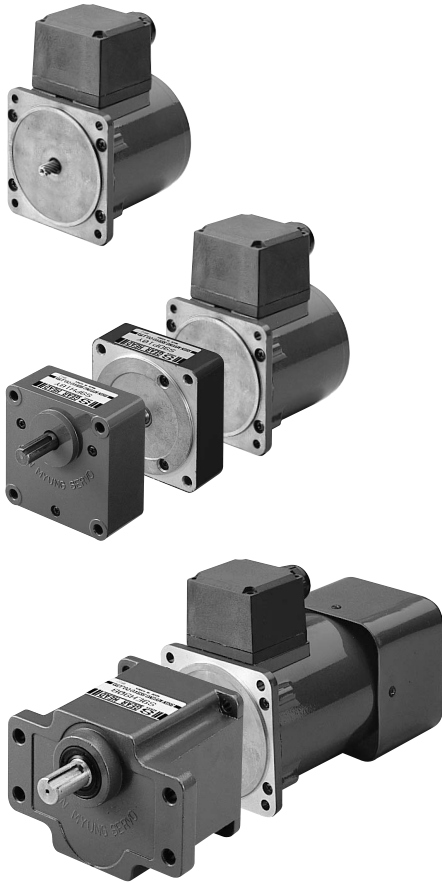
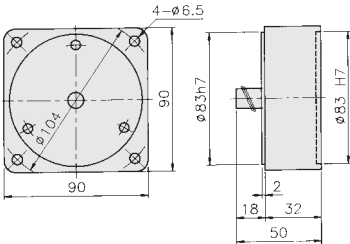

③ 9P□B
9P□Y

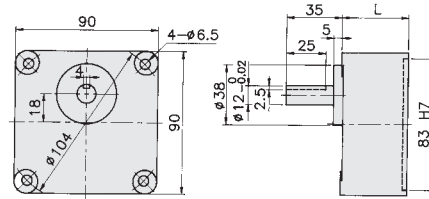

GEAR RATIO	L mm	WEIGHT(kg)	BOLT
1/3~1/18	42	0.8	M6×65
1/25~1/180	60	0.9	M6×80

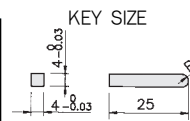

⑤ 9E□B

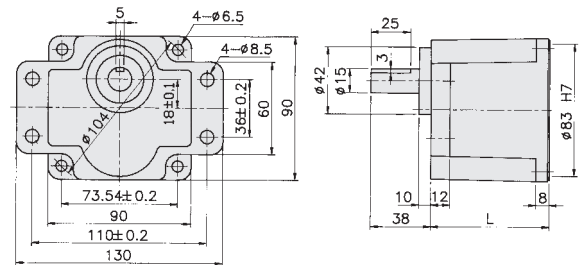

GEAR RATIO	L mm	WEIGHT(kg)	BOLT
1/3~1/60	65	1.6	M6×25
1/75~1/180	85	2.0	M6×25

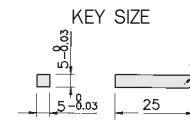

WIRING(SINGLE PHASE MOTOR)

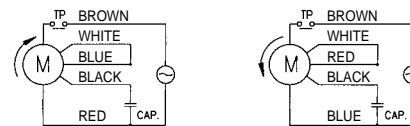

* Facing output shaft

- ⊕ THE NORMAL TORQUE(kg·cm) IS THAT THE MOTOR & GEAR HEAD ARE DIRECTLY COUPLED.
- ⊕ INSERT THE DENOMINATOR OF REDUCTION RATIO IN □ OF GEAR HEAD MODEL NAME.
- ⊕ ACTUAL ROTATION SPEED IS 2-15% LESS THAN SYNCHRONOUS SPEED.

DECIMAL GEAR HEAD	GEAR HEAD MODEL	SYNCHRONOUS SPEED (RPM)	600	360	240	144	100	60	36	24	18	12	7.2	5	3	2	1
			500	300	200	120	72	50	30	20	15	10	6	3.6	2.4	1.2	
		DENOMINATOR OF REDUCTION RATIO (60Hz)	3	5	7.5	12.5	18	30	50	75	100	150	250	360	600	900	1800
			3.6	6	9	15	25	36	60	90	120	180	300	500	750	1500	
④9DP10Y	③9P□Y, 9P□B		6	10	15	25	36	54	82	120	120	120	D120	D120	D120	D120	D120
			7	12	18	30	45	65	98	120	120	120	D120	D120	D120	D120	
④9DP10Y	③9P□Y, 9P□B		9	15	23	38	55	83	120	120	120	120	D120	D120	D120	D120	D120
			11	18	27	46	69	99	120	120	120	120	D120	D120	D120	D120	
-	⑤9E□B		13	23	34	57	83	124	186	280	300	300					
			16	27	41	69	103	149	224	300	300	300					

■ COLOR INDICATES THAT THE ROTATION OF GEARHEAD SHAFT IS IN OPPOSITE DIRECTION AS OUTPUT SHAFT OF MOTOR
D:USE DECIMAL GEAR

INDUCTION MOTOR

MOTOR

N - T CURVE

MOTOR DIMENSIONS

PINION SHAFT

③② **9IN40S4** □
9IN40P4 □

WEIGHT 2.5kg

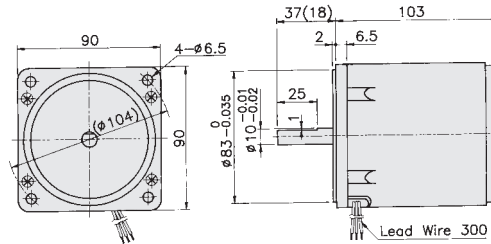
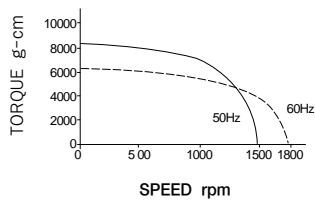

MODULE 0.6
PRESSURE 20°
TEETH No. 12
DIAMETER ϕ 9.63mm
LENGTH 18mm

32

③③ **9IF60S4** □
9IF60P4 □

WEIGHT 2.6kg

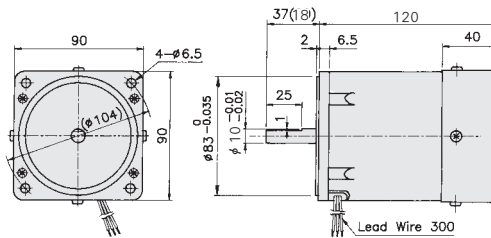
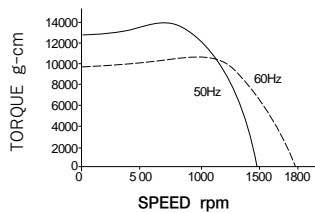

MODULE 0.6
PRESSURE ANGLE 20°
TEETH No. 12
DIAMETER ϕ 9.63mm
LENGTH 18mm



◆ ELECTRICAL PERFORMANCES

- THREE PHASE, 4 POLES, CONTINUOUS DUTY, INSULATION CLASS "E"

FIG NO.	MODEL		OUTPUT W	VOLTAGE V	FREQUENCY Hz	RATED					STARTING TORQUE	
	STRAIGHT SHAFT	PINION SHAFT				SPEED rpm	INPUT W	CURRENT mA	TORQUE		kg-cm	N-m
									kg-cm	N-m		
③②	9IN40S4J	9IN40P4J	40	220	50	1300	90	400	3.00	0.294	6.50	0.637
					60	1550	90	400	2.60	0.255	5.00	0.490
③②	9IN40S4K	9IN40P4K	40	380	50	1300	90	230	3.00	0.294	6.50	0.637
					60	1550	90	230	2.60	0.255	5.00	0.490
③②	9IN40S4Z	9IN40P4Z	40	440	50	1300	90	200	3.00	0.294	6.50	0.637
					60	1550	90	200	2.60	0.255	5.00	0.490
③③	9IF60S4J	9IF60P4J	60	220	50	1300	135	600	4.50	0.441	7.50	0.735
					60	1550	135	600	3.80	0.372	6.00	0.588
③③	9IF60S4K	9IF60P4K	60	380	50	1300	135	350	4.50	0.441	7.50	0.735
					60	1550	135	350	3.80	0.372	7.50	0.588
③③	9IF60S4Z	9IF60P4Z	60	440	50	1300	135	300	4.50	0.441	7.50	0.735
					60	1550	135	300	3.80	0.372	6.00	0.588

GEAR HEAD

DECIMAL GEAR HEAD (RATIO 1/10)

GEAR HEAD (RATIO 1/3~1/180)

④ 9DP10Y WEIGHT 0.6kg

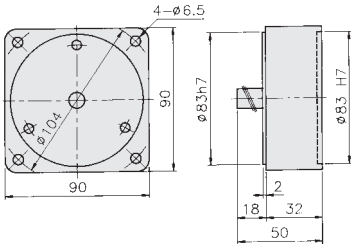

③ 9P□B
9P□Y

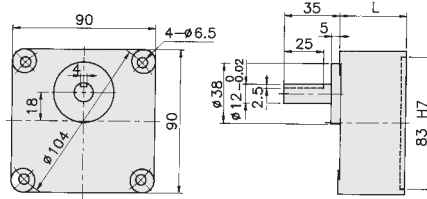

GEAR RATIO	L mm	WEIGHT(kg)	BOLT
1/3~1/18	42	0.8	M6×65
1/25~1/180	60	0.9	M6×80

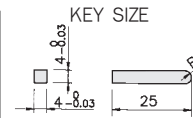

WIRING(THREE PHASE MOTOR)

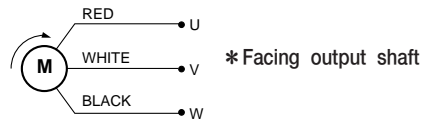

As for CCW rotation, change the 2wires among U.V.W shown above.

- ⊕ THE NORMAL TORQUE(kg·cm) IS THAT THE MOTOR & GEAR HEAD ARE DIRECTLY COUPLED.
- ⊕ INSERT THE DENOMINATOR OF REDUTION RATIO IN □ OF GEAR HEAD MODEL NAME.
- ⊕ ACTUAL ROTATION SPEED IS 2-15% LESS THAN SYNCHRONOUS SPEED.

DECIMAL GEAR HEAD	GEAR HEAD MODEL	SYNCHRONOUS SPEED (RPM)																
		DENOMINATOR OF REDUCTION RATIO	500	300	200	120	100	60	50	30	20	15	10	6	5	3	2	1
			50Hz	3	5	7.5	12.5	15	25	30	50	75	100	150	250	300	500	750
④S9DP10Y	③9P□Y, 9P□B	60Hz	3.6	6	9	15	18	30	36	60	90	120	180	300	360	600	900	1800
④S9DP10Y	③9P□Y, 9P□B		7.6	13	19	32	38	57	68	102	120	120	120	D 120	D 120	D 120	D 120	D 120
④S9DP10Y	③9P□Y, 9P□B		7.6	13	19	32	38	57	68	102	120	120	120	D 120	D 120	D 120	D 120	D 120
④S9DP10Y	③9P□Y, 9P□B		7.6	13	19	32	38	57	68	102	120	120	120	D 120	D 120	D 120	D 120	D 120
④S9DP10Y	③9P□Y, 9P□B		11	18	28	46	55	83	100	120	120	120	120	D 120	D 120	D 120	D 120	D 120
④S9DP10Y	③9P□Y, 9P□B		11	18	28	46	55	83	100	120	120	120	120	D 120	D 120	D 120	D 120	D 120
④S9DP10Y	③9P□Y, 9P□B		11	18	28	46	55	83	100	120	120	120	120	D 120	D 120	D 120	D 120	D 120

■ COLOR INDICATES THAT THE ROTATION OF GEARHEAD SHAFT IS IN OPPOSITE DIRECTION AS OUTPUT SHAFT OF MOTOR
D:USE DECIMAL GEAR

INDUCTION MOTOR

MOTOR

N - T CURVE

MOTOR DIMENSIONS

PINION SHAFT

34

34 91F60E4 □

WEIGHT 2.6kg

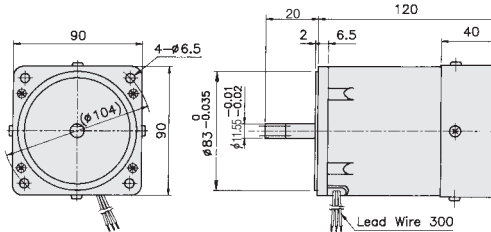
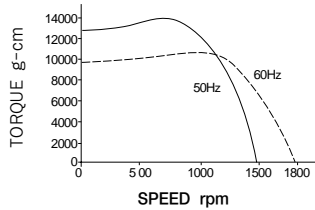

MODULE 0.8
PRESSURE ANGLE 20°
TEETH No. 11
DIAMETER ϕ 11.55mm
LENGTH 20mm

35 91F90S4 □ 91F90E4 □

WEIGHT 3.2kg

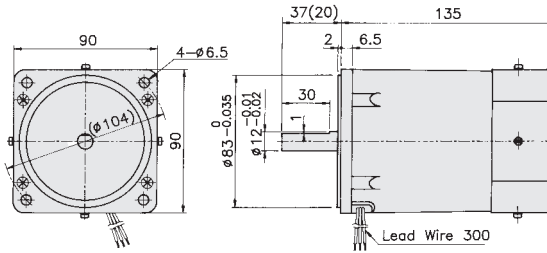
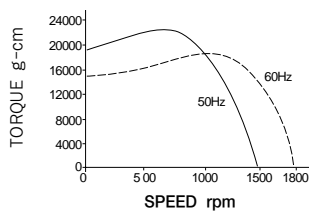

MODULE 0.8
PRESSURE ANGLE 20°
TEETH No. 11
DIAMETER ϕ 11.55mm
LENGTH 20mm

36 91F120S4 □ 91F120E4 □

WEIGHT 3.2kg

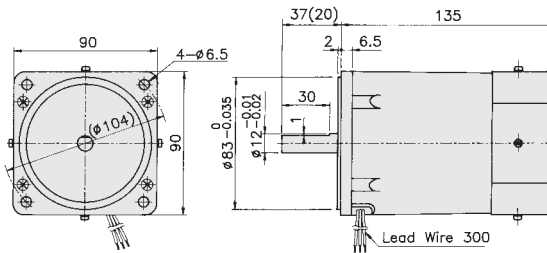
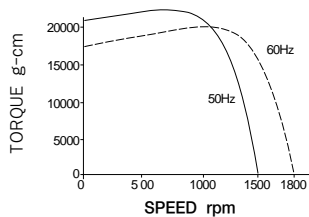

MODULE 0.8
PRESSURE ANGLE 20°
TEETH No. 11
DIAMETER ϕ 11.55mm
LENGTH 20mm

◆ ELECTRICAL PERFORMANCES

- THREE PHASE, 4 POLES, CONTINUOUS DUTY, INSULATION CLASS "E"

FIG NO.	MODEL		OUTPUT W	VOLTAGE V	FREQUENCY Hz	RATED					STARTING TORQUE	
	STRAIGHT SHAFT	PINION SHAFT				SPEED rpm	INPUT W	CURRENT mA	TORQUE		kg-cm	N-m
									kg-cm	N-m		
34	-	91F60E4J	60	220	50	1300	135	600	4.50	0.441	7.50	0.735
					60	1550	135	600	3.80	0.372	6.00	0.588
34	-	91F60E4K	60	380	50	1300	135	350	4.50	0.441	7.50	0.735
					60	1550	135	350	3.80	0.372	6.00	0.588
34	-	91F60E4Z	60	440	50	1300	135	300	4.50	0.441	7.50	0.735
					60	1550	135	300	3.80	0.372	6.00	0.588
35	91F90S4J	91F90E4J	90	220	50	1250	180	800	6.80	0.666	8.50	0.833
					60	1500	180	800	5.70	0.559	7.00	0.686
35	91F90S4K	91F90E4K	90	380	50	1250	180	450	6.80	0.666	8.50	0.833
					60	1500	180	450	5.70	0.559	7.00	0.686
35	91F90S4Z	91F90E4Z	90	440	50	1250	180	400	6.80	0.666	8.50	0.833
					60	1500	180	400	5.70	0.559	7.00	0.686
36	91F120S4J	91F120E4J	120	220	50	1300	240	1000	9.00	0.882	16.00	1.568
					60	1550	240	1000	7.60	0.745	14.00	1.372
36	91F120S4K	91F120E4K	120	380	50	1300	240	600	9.00	0.882	16.00	1.568
					60	1550	240	600	7.60	0.745	14.00	1.372
36	91F120S4Z	91F120E4Z	120	440	50	1300	240	500	9.00	0.882	16.00	1.568
					60	1550	240	500	7.60	0.745	14.00	1.372

GEAR HEAD

DECIMAL GEAR HEAD (RATIO 1/10)

GEAR HEAD (RATIO 1/3~1/180)



5 9E□B

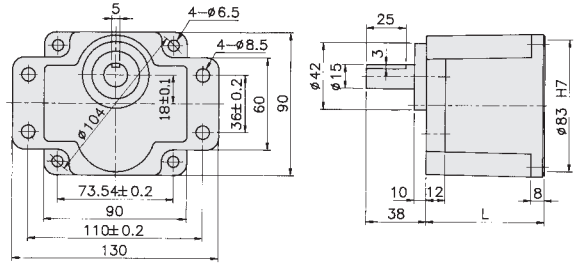

GEAR RATIO	L mm	WEIGHT(kg)	BOLT
1/3~1/60	65	1.6	M6×25
1/75~1/180	85	2.0	M6×25

KEY SIZE

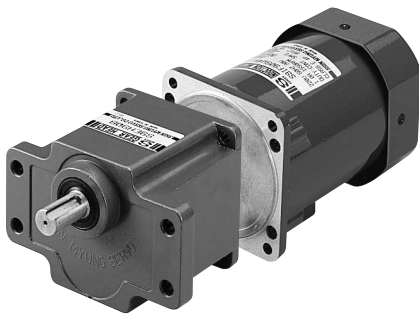
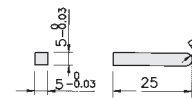

WIRING(THREE PHASE MOTOR)

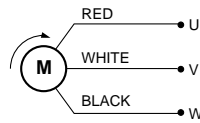

*Facing output shaft

- ⊕ THE NORMAL TORQUE(kg-cm) IS THAT THE MOTOR & GEAR HEAD ARE DIRECTLY COUPLED.
- ⊕ INSERT THE DENOMINATOR OF REDUTION RATIO IN □ OF GEAR HEAD MODEL NAME.
- ⊕ ACTUAL ROTATION SPEED IS 2-15% LESS THAN SYNCHRONOUS SPEED.

DECIMAL GEAR HEAD	GEAR HEAD MODEL	SYNCHRONOUS SPEED (RPM)																		
		DENOMINATOR OF REDUCTION RATIO	500 300 200 120 100 60 50 30 20 15 10 6 5 3 2 1																	
			50Hz	3	5	7.5	12.5	15	25	30	50	75	90	150	202	269	300	-	-	-
-	5 9E□B	60Hz	3.6	6	9	15	18	30	36	60	90	120	180	300	360	600	900	1800	-	-
-	5 9E□B	50Hz	11	18	28	42	50	75	90	150	202	269	300	-	-	-	-	-	-	-
-	5 9E□B	60Hz	11	18	28	42	50	75	90	150	202	269	300	-	-	-	-	-	-	-
-	5 9E□B	50Hz	17	28	42	62	75	112	135	224	300	300	300	-	-	-	-	-	-	-
-	5 9E□B	60Hz	17	28	42	62	75	112	135	224	300	300	300	-	-	-	-	-	-	-
-	5 9E□B	50Hz	17	28	42	62	75	112	135	224	300	300	300	-	-	-	-	-	-	-
-	5 9E□B	60Hz	22	37	55	83	100	150	180	299	300	300	300	-	-	-	-	-	-	-
-	5 9E□B	50Hz	22	37	55	83	100	150	180	299	300	300	300	-	-	-	-	-	-	-
-	5 9E□B	60Hz	22	37	55	83	100	150	180	299	300	300	300	-	-	-	-	-	-	-

■ COLOR INDICATES THAT THE ROTATION OF GEARHEAD SHAFT IS IN OPPOSITE DIRECTION AS OUTPUT SHAFT OF MOTOR

INDUCTION MOTOR (2 POLES)

MOTOR

N - T CURVE

MOTOR DIMENSIONS

36

③⑦ 9IF90S2L 9IF90S2H

WEIGHT 2.6kg

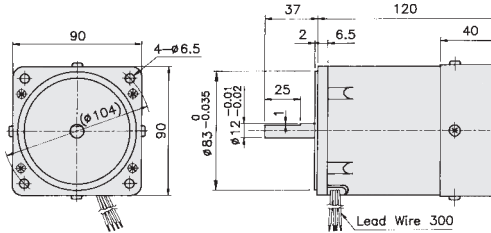
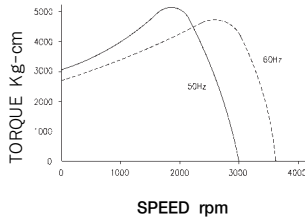

③⑧ 9IF150S2L 9IF150S2H

WEIGHT 3.2kg

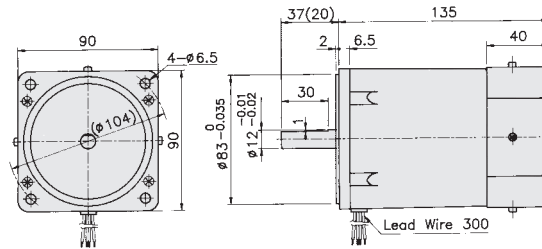
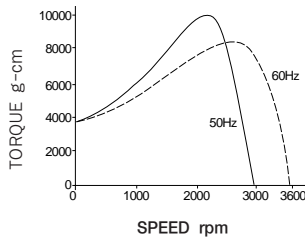

WIRING

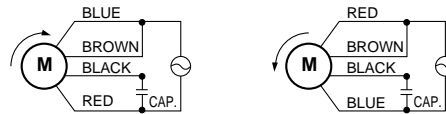

* Facing output shaft

⊕ ELECTRICAL PERFORMANCES

- SINGLE PHASE, 2 POLES, CONTINUOUS DUTY, INSULATION CLASS "E"

FIG NO.	MODEL	OUTPUT W	VOLTAGE V	FREQUENCY Hz	RATED				STARTING TORQUE		STARTING CURRENT mA	CAPACITOR μF	
					SPEED rpm	INPUT W	CURRENT mA	TORQUE					
③⑦	9IF90S2L	90	100	50	2600	190	1800	3.40	0.333	2.30	0.225	1400	16
				60	3150	190	2000	2.80	0.274	2.30	0.225	1500	
③⑦	9IF90S2H	90	220	50	2600	280	1500	3.40	0.333	2.30	0.225	2400	5.0
				60	3200	250	1200	2.80	0.274	2.30	0.225	2400	
③⑧	9IF150S2L	150	100	50	2650	300	2800	5.60	0.549	3.80	0.372	6800	40
				60	3200	300	3200	4.60	0.451	3.80	0.372	6600	
③⑧	9IF150S2H	150	220	50	2650	300	1400	5.60	0.549	3.80	0.372	3400	8
				60	3200	300	1600	4.60	0.451	3.80	0.372	3300	

REVERSIBLE MOTOR

A condenser driven type single-phase reversible motor has both 100V and 220V models. Designed to operate in alternative repetition such as opening and closing gate, normal and the reversible movement of lift, starting and halting operation with the following features.

1. RATED HOUR

Suitable for using in operation where starting torque is necessary to be large and a short time is needed to reach loading torque, as continuous operation should be limited within 30 minutes. When normal and reversible operation or start and stop repetition is continued, the motor can be operated long within the temperature of the motor case at 90°C or below keeping an interval between the stops long.

2. CONTROLLER AND CONTROLLING TORQUE

Motor's responding speed is required to be quick at the operation of normal and reversible revolution, braking and stopping.

The reversible motor with built-in controller works the mechanical controlling torque all the time as shown in the picture below. So the motor is designed to make an easy alternation from normal to reverse motions and the like while in operation.

* The life length of the controlling brush is about 5000 hours.

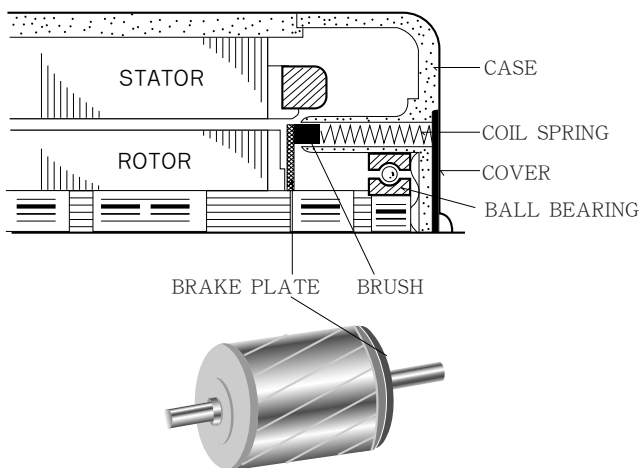

* The following indicates motor's control characteristics.

MODEL	BRAKE TORQUE (g-cm)	OVER RUN	OVER RUN WITHOUT SOFT BRAKE
6RN6S	100	3-4	30~50
8RN20S	150	3-4	40~60
8RN25S	220	3-4	50~70
9RN40S	600	4-5	80~100
9RN60S	600	5-6	80~100
9RF90S	600	5-6	80~100
9RF120S	600	5-6	80~100

2) BRAKE TORQUE

The motor with controller makes resistance as brake torque when the motor axle is turned by outside force at the stop condition.

3. OVER RUN & BRAKE TORQUE

1) OVER RUN

When the motor runs in no-load condition at the rated voltage, the rotor continues to run by an inertia after electricity is off.

REVERSIBLE MOTOR (C € approved)

6W

□ 60mm

LEAD WIRE TYPE

MOTOR DIMENSIONS

38



6RN6S4H(L)

WEIGHT 0.7kg

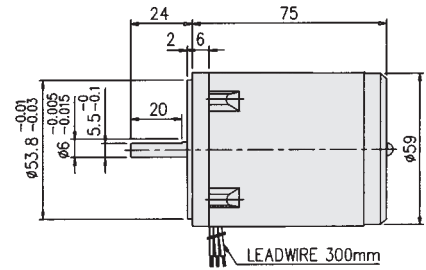
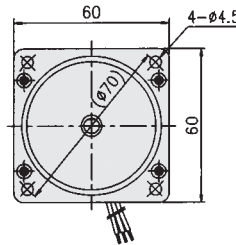

6RN6G4H(L)

WEIGHT 0.7kg

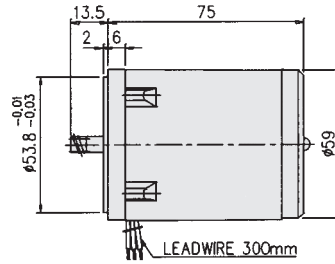
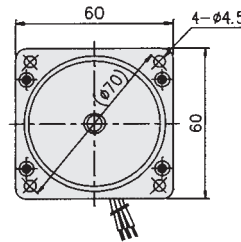

WIRING DIAGRAM

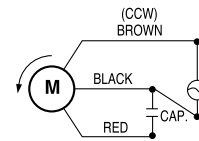
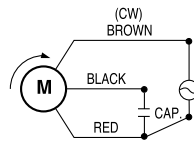

⊕ ELECTRICAL PERFORMANCES

- SINGLE PHASE, 4 POLES, 30MIN DUTY, INSULATION CLASS "E"

MODEL		OUTPUT W	VOLTAGE V	FREQUENCY Hz	RATED					STARTING TORQUE		STARTING CURRENT mA	CAPACITOR μF
STRAIGHT SHAFT	PINION SHAFT				SPEED rpm	INPUT W	CURRENT mA	TORQUE		kg-cm	N-m		
6RN6S4L	6RN6G4L	6	100	50	1250	28	280	0.5	0.05	0.55	0.055	400	4
				60	1550	28	280	0.4	0.04	0.55	0.055	400	4
6RN6S4H	6RN6G4H	6	220	50	1250	36	160	0.5	0.05	0.68	0.069	200	1
				60	1550	36	160	0.4	0.04	0.68	0.069	200	1
6RN6S4C	6RN6G4C	6	220~240	50	1250	40	180	0.4	0.04	0.68	0.069	220	1

GEAR HEAD

MOTOR DIMENSIONS



GEARHEAD 6G□Y(B)

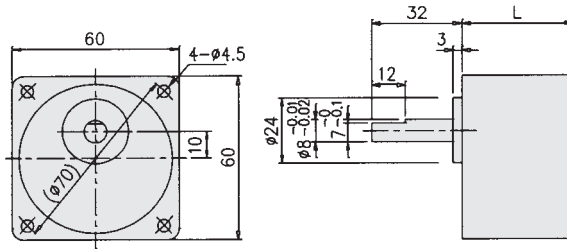

GEAR RATIO	L mm	WEIGHT(kg)	BOLT
1/3~1/18	30	0.25	M4×50
1/25~1/180	40	0.35	M4×60

DECIMAL GEARHEAD 6DG10Y(B)

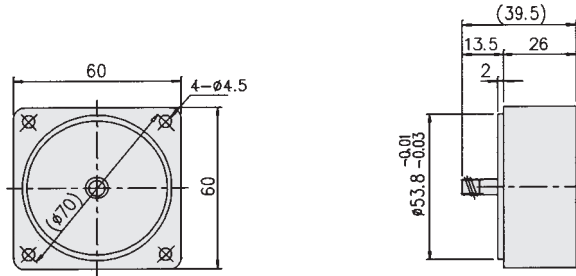

- ⊕ □ OF GEAR HEAD MODEL NAME INDICATE THE DEDUCTION RATIO.
- ⊕ THE NORMAL TORQUE(kg·cm) IS THAT THE MOTOR & GEAR HEAD ARE DIRECTLY COUPLED.
- ⊕ THE NORMAL TORQUE(kg·cm) IS 30kg·cm IN CASE THE DECIMAL GEARHEAD OF THE DEDUCTION RATIO 1/10 IS CONNECTED.
- ⊕ THE ROTATION DIRECTION OF OUTPUT SHAFT FOR THE GEARHEAD INDICATED ■ ROTATES WITH MOTOR ON THE CONTRARY.
- ⊕ THE ACTUAL ROTATION SPEED IS 2-20% LESS THAN SYNCHRONOUS SPEED ACCORDING TO THE SIZE OF THE LOAD.

50HZ

MODEL	rpm	500	416	300	250	200	166	120	100	83	75	60	50	42	30	25	20	16	15	12	10	8
	Ratio	3	3.6	5	6	7.5	9	12.5	15	18	20	25	30	36	50	60	75	90	100	120	150	180
6G□Y 6G□B	kg-cm	1.3	1.5	2.1	2.6	3.2	3.9	5.4	6.4	7.7	8.5	9.7	11.6	13.9	17.5	21.0	26.2	30	30	30	20	30
	N-m	0.13	0.15	0.21	0.26	0.31	0.38	0.53	0.63	0.75	0.83	0.95	1.14	1.36	1.72	2.06	2.57	2.94	2.94	2.94	2.94	2.94

60HZ

MODEL	rpm	600	500	360	300	240	200	144	120	100	90	72	60	50	36	30	24	20	18	15	12	10
	Ratio	3	3.6	5	6	7.5	9	12.5	15	18	20	25	30	36	50	60	75	90	100	120	150	180
6G□Y 6G□B	kg-cm	1.0	1.3	1.7	2.1	2.6	3.1	4.4	5.2	6.3	6.6	8.2	9.8	11.8	16.4	18.2	22.5	26.5	29.5	30	30	30
	N-m	0.10	0.13	0.17	0.21	0.25	0.30	0.43	0.51	0.62	0.65	0.84	0.96	1.16	1.60	1.78	2.20	2.59	2.89	2.94	2.94	2.94

REVERSIBLE MOTOR

MOTOR

N - T CURVE

MOTOR DIMENSIONS

PINION SHAFT

40

① **8RN20S4** □
8RN20GN4 □

WEIGHT 1.5kg

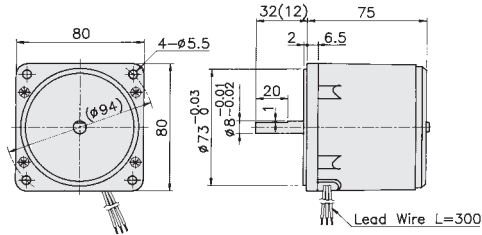
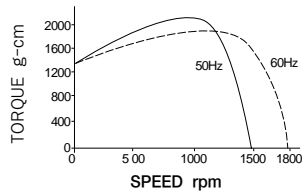

MODULE 0.5
PRESSURE ANGLE 20°
TEETH No. 10
DIAMETER ϕ 7.2mm
LENGTH 12mm

② **8RN25S4** □
8RN25GN4 □

WEIGHT 1.6kg

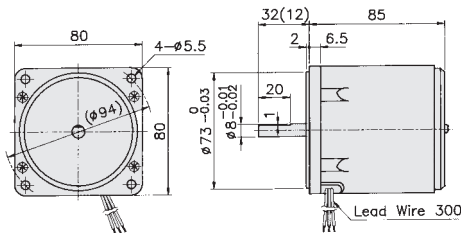
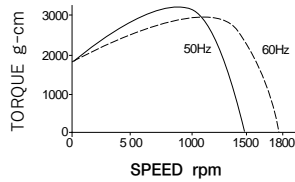

MODULE 0.5
PRESSURE ANGLE 20°
TEETH No. 10
DIAMETER ϕ 7.2mm
LENGTH 12mm



⊕ ELECTRICAL PERFORMANCES

- SINGLE PHASE, 4 POLES, 30MIN DUTY, INSULATION CLASS "E"

FIG NO.	MODEL		OUTPUT W	VOLTAGE V	FREQUENCY Hz	RATED					STARTING TORQUE		STARTING CURRENT mA	CAPACITOR μF
	STRAIGHT SHAFT	PINION SHAFT				SPEED rpm	INPUT W	CURRENT mA	TORQUE		kg-cm	Nm		
									kg-cm	Nm				
①	8RN20S4L	8RN20GN4L	20	100	50	1250	50	500	1.50	0.147	1.04	0.102	900	8
						1550	50	500	1.17	0.115	1.04	0.102	850	
①	8RN20S4H	8RN20GN4H	20	220	50	1250	60	280	1.50	0.147	1.04	0.102	430	1.5
						1550	60	280	1.17	0.115	1.04	0.102	430	
②	8RN25S4L	8RN25GN4L	25	100	50	1300	65	650	1.80	0.176	1.28	0.125	1250	10
						1600	65	650	1.37	0.134	1.28	0.125	1200	
②	8RN25S4H	8RN25GN4H	25	220	50	1300	70	330	1.80	0.176	1.28	0.125	600	2
						1600	70	330	1.37	0.134	1.28	0.125	550	

GEAR HEAD

DECIMAL GEAR HEAD (RATIO 1/10)

GEAR HEAD (RATIO 1/3~1/180)

② 8DGN10Y WEIGHT 0.3kg

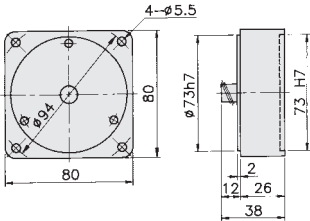

① 8GN□B
8GN□Y

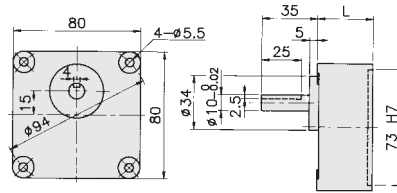

GEAR RATIO	L mm	WEIGHT(kg)	BOLT
1/3~1/18	30	0.5	M5×50
1/25~1/180	40	0.6	M5×60

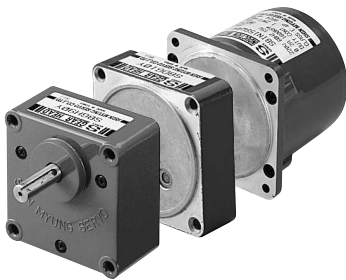
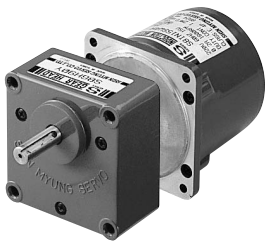
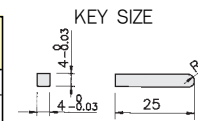

WIRING(SINGLE PHASE MOTOR)

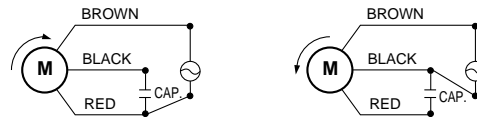

*Facing output shaft

- ⊕ THE NORMAL TORQUE(kg·cm) IS THAT THE MOTOR & GEAR HEAD ARE DIRECTLY COUPLED.
- ⊕ INSERT THE DENOMINATOR OF REDUTION RATIO IN □ OF GEAR HEAD MODEL NAME.
- ⊕ ACTUAL ROTATION SPEED IS 2-15% LESS THAN SYNCHRONOUS SPEED.

DECIMAL GEAR HEAD	GEAR HEAD MODEL	SYNCHRONOUS SPEED (RPM)		500	300	200	120	100	60	50	30	20	15	10	6	5	3	2	1
		DENOMINATOR OF REDUCTION RATIO	50Hz	3	5	7.5	12.5	15	25	30	50	75	100	150	250	300	500	750	1500
			60Hz	3.6	6	9	15	18	30	36	60	90	120	180	300	360	600	900	1800
②8DGN10Y	①8GN□Y, 8GN□B		3.4	5.7	8.5	14	17	26	31	46	69	92	100	D35	D35	D65	D80	D100	
②8DGN10Y	①8GN□Y, 8GN□B		3.4	5.7	8.5	14	17	26	31	46	69	92	100	D35	D35	D65	D80	D100	
②8DGN10Y	①8GN□Y, 8GN□B		4.0	6.7	10	17	20	30	36	54	81	100	100	D35	D35	D65	D80	D100	
②8DGN10Y	①8GN□Y, 8GN□B		4.0	6.7	10	17	20	30	36	54	81	100	100	D35	D35	D65	D80	D100	

■ COLOR INDICATES THAT THE ROTATION OF GEARHEAD SHAFT IS IN OPPOSITE DIRECTION AS OUTPUT SHAFT OF MOTOR
D:USE DECIMAL GEAR

REVERSIBLE MOTOR

MOTOR

N - T CURVE

③ 9RN40S4□
9RN40P4□

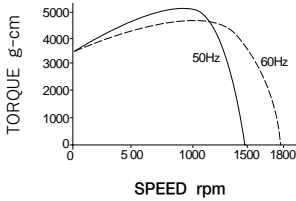

MOTOR DIMENSIONS

WEIGHT 2.5kg

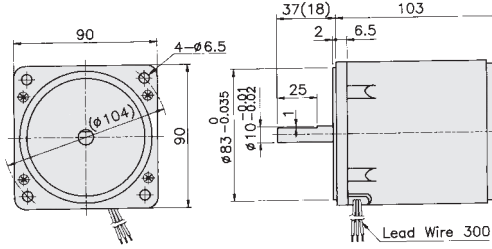

PINION SHAFT

MODULE 0.6
PRESSURE ANGLE 20°
TEETH No. 12
DIAMETER ϕ 9.63mm
LENGTH 18mm

42

④ 9RN60S4□
9RN60E4□

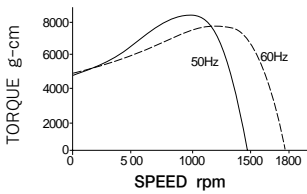

WEIGHT 2.6kg

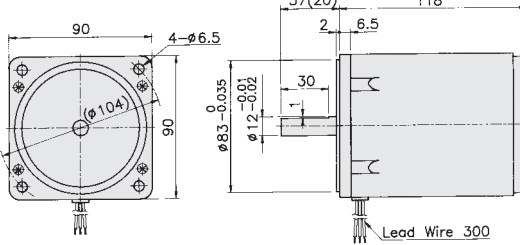

MODULE 0.8
PRESSURE ANGLE 20°
TEETH No. 11
DIAMETER ϕ 11.55mm
LENGTH 20mm

⑤ 9RF90S4□
9RF90E4□

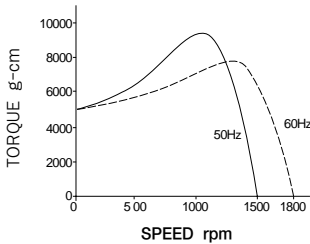

WEIGHT 2.6kg

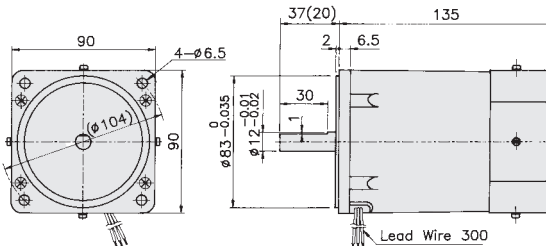

MODULE 0.8
PRESSURE ANGLE 20°
TEETH No. 11
DIAMETER ϕ 11.55mm
LENGTH 20mm

⑥ 9RF120S4□
9RF120E4□

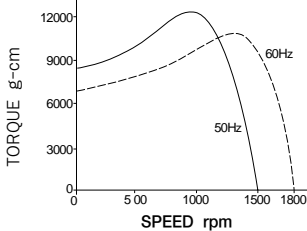

WEIGHT 2.6kg

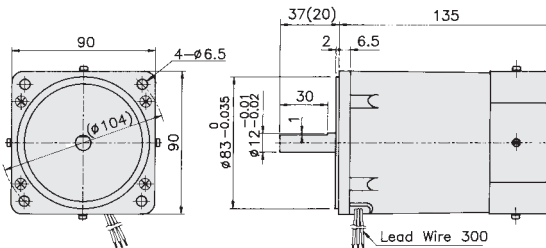

MODULE 0.8
PRESSURE ANGLE 20°
TEETH No. 11
DIAMETER ϕ 11.55mm
LENGTH 20mm

⊕ ELECTRICAL PERFORMANCES

- SINGLE PHASE, 4 POLES, 30MIN DUTY, INSULATION CLASS "E"

FIG NO.	MODEL		OUTPUT W	VOLTAGE V	FREQUENCY Hz	RATED				STARTING TORQUE		STARTING CURRENT mA	CAPACITOR μ F	
	STRAIGHT SHAFT	PINION SHAFT				SPEED rpm	INPUT W	CURRENT mA	TORQUE		kg-cm			Nm
③	9RN40S4L	9RN40P4L	40	100	50	1200	115	1150	3.20	0.314	2.60	0.255	1850	16
					60	1500	115	1150	2.60	0.255	2.60	0.255	1850	
③	9RN40S4H	9RN40P4H	40	220	50	1200	140	650	3.20	0.314	2.60	0.255	900	3.5
					60	1500	140	650	2.60	0.255	2.60	0.255	900	
④	9RN60S4L	9RN60E4L	60	100	50	1300	180	1800	4.50	0.441	3.50	0.343	3000	25
					60	1600	180	1800	3.80	0.372	3.50	0.343	3000	
④	9RN60S4H	9RN60E4H	60	220	50	1300	220	1000	4.50	0.441	3.50	0.343	1700	5
					60	1600	220	1000	3.80	0.372	3.50	0.343	1700	
⑤	9RF90S4L	9RF90E4L	90	100	50	1250	200	2000	6.80	0.666	4.20	0.412	3200	25
					60	1550	200	2000	5.70	0.559	4.20	0.412	3000	
⑤	9RF90S4H	9RF90E4H	90	220	50	1250	200	1000	6.80	0.666	4.20	0.412	1600	5
					60	1550	200	1000	5.70	0.559	4.20	0.412	1500	
⑥	9RF120S4L	9RF120E4L	120	100	50	1350	240	2400	8.70	0.853	6.00	0.588	4800	35
					60	1600	240	2400	7.30	0.715	6.00	0.588	4600	
⑥	9RF120S4H	9RF120E4H	120	220	50	1300	320	1400	8.70	0.853	6.00	0.588	2200	7
					60	1600	320	1400	7.30	0.715	6.00	0.588	2200	

GEAR HEAD

DECIMAL GEAR HEAD (RATIO 1/10)

GEAR HEAD (RATIO 1/3~1/180)

④ 9DP10Y WEIGHT 0.6kg

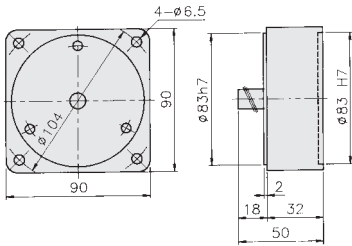

③ 9P□B
9P□Y

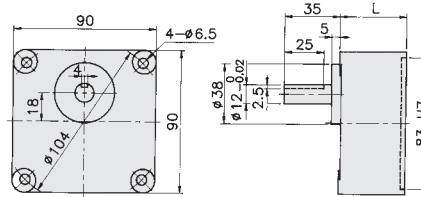

GEAR RATIO	mm L	WEIGHT(kg)	BOLT
1/3~1/18	42	0.8	M6×65
1/25~1/180	60	0.9	M6×80

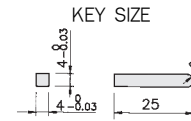

⑤ 9E□B

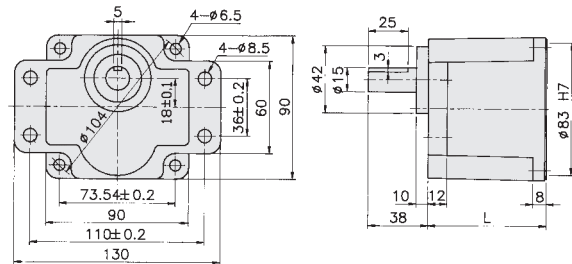

GEAR RATIO	mm L	WEIGHT(kg)	BOLT
1/3~1/60	65	1.6	M6×25
1/75~1/180	85	2.0	M6×25

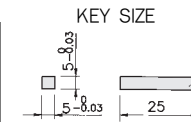

WIRING(SINGLE PHASE MOTOR)

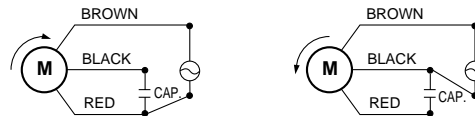

*Facing output shaft

- ⊕ THE NORMAL TORQUE(kg·cm) IS THAT THE MOTOR & GEAR HEAD ARE DIRECTLY COUPLED.
- ⊕ INSERT THE DENOMINATOR OF REDUTION RATIO IN □ OF GEAR HEAD MODEL NAME.
- ⊕ ACTUAL ROTATION SPEED IS 2-15% LESS THAN SYNCHRONOUS SPEED.

DECIMAL GEAR HEAD	GEAR HEAD MODEL	SYNCHRONOUS SPEED (RPM)																
		DENOMINATOR OF REDUCTION RATIO	500	300	200	120	100	60	50	30	20	15	10	6	5	3	2	1
			50Hz	3	5	7.5	12.5	15	25	30	50	75	100	150	250	300	500	750
④9DP10Y	③9P□Y 9P□B	60Hz	3.6	6	9	15	18	30	36	60	90	120	180	300	360	600	900	1800
④9DP10Y	③9P□Y S9P□B	60Hz	3.6	6	9	15	18	30	36	60	90	120	180	300	360	600	900	1800
—	⑤9E□B	60Hz	11	18	28	42	50	75	90	150	202	269	300	-	-	-	-	-
—	⑤9E□B	60Hz	11	18	28	42	50	75	90	150	202	269	300	-	-	-	-	-
—	⑤9E□B	60Hz	17	28	42	62	75	112	135	224	300	300	300	-	-	-	-	-
—	⑤9E□B	60Hz	17	28	42	62	75	112	135	224	300	300	300	-	-	-	-	-
—	⑤9E□B	60Hz	21	35	53	80	96	144	172	287	300	300	300	-	-	-	-	-
—	⑤9E□B	60Hz	21	35	53	80	96	144	172	287	300	300	300	-	-	-	-	-

■ COLOR INDICATES THAT THE ROTATION OF GEARHEAD SHAFT IS IN OPPOSITE DIRECTION AS OUTPUT SHAFT OF MOTOR
D:USE DECIMAL GEAR

SPEED CONTROL INDUCTION MOTOR

MOTOR

N - T CURVE

MOTOR DIMENSIONS

PINION SHAFT

① 8IN15S4□-V 8IN15GN4□-V

WEIGHT 1.6kg

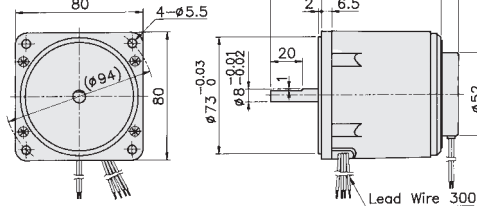
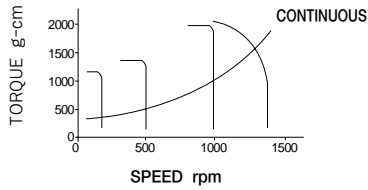

MODULE 0.5
PRESSURE ANGLE 20°
TEETH No. 10
DIAMETER φ7.2mm
LENGTH 12mm

44

② 8IN25S4□-V 8IN25GN4□-V

WEIGHT 1.7kg

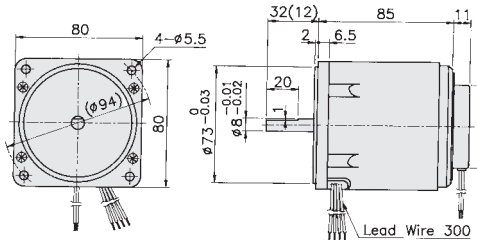
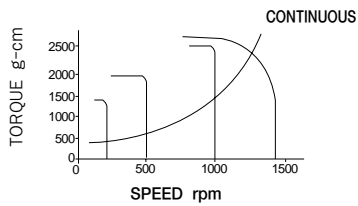

MODULE 0.5
PRESSURE ANGLE 20°
TEETH No. 10
DIAMETER φ7.2mm
LENGTH 12mm



⊕ ELECTRICAL PERFORMANCES

- SINGLE PHASE, 4 POLES, CONTINUOUS DUTY, INSULATION CLASS "E"

FIG NO.	MODEL		MAXIMUM OUTPUT W	VOLTAGE V	FREQUENCY Hz	VARIABLE SPEED RANGE rpm	MAXIMUM CURRENT mA	STARTING TORQUE		ALLOWABLE TORQUE		CAPACITOR μF
	STRAIGHT SHAFT	PINION SHAFT						kg-cm	N-m	kg-cm	N-m	
①	8IN15S4L-V	8IN15GN4L-V	15	100	50 / 60	70~1400	460	0.68	0.067	0.30~1.6	0.029~0.157	3
①	8IN15S4H-V	8IN15GN4H-V	15	220	50 / 60	70~1400	250	0.68	0.067	0.30~1.6	0.029~0.157	1.2
②	8IN25S4L-V	8IN25GN4L-V	25	100	50 / 60	70~1400	600	1.00	0.098	0.35~1.9	0.034~0.186	6
②	8IN25S4H-V	8IN25GN4H-V	25	220	50 / 60	70~1400	320	1.00	0.098	0.35~1.10	0.034~0.186	1.5

GEAR HEAD

DECIMAL GEAR HEAD (RATIO 1/10)

GEAR HEAD (RATIO 1/3~1/180)

2 8DGN10Y WEIGHT 0.6kg

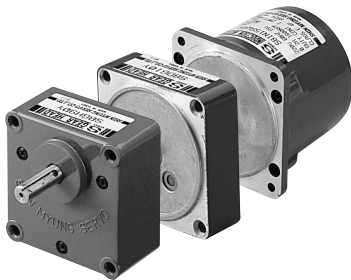
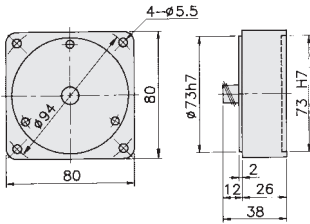

1 8GN□B
8GN□Y

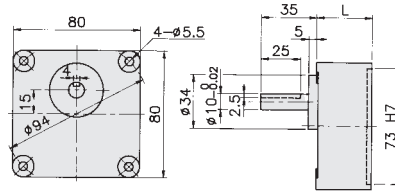

GEAR RATIO	mm L	WEIGHT(kg)	BOLT
1/3~1/18	30	0.5	M5 x 50
1/25~1/180	40	0.6	M5 x 60

KEY SIZE

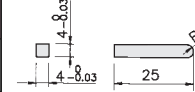

WIRING(SINGLE PHASE MOTOR)

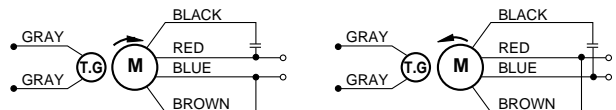

*Facing output shaft

- ⊕ THE NORMAL TORQUE(kg·cm) IS THAT THE MOTOR & GEAR HEAD ARE DIRECTLY COUPLED.
- ⊕ INSERT THE DENOMINATOR OF REDUCTION RATIO IN □ OF GEAR HEAD MODEL NAME.
- ⊕ ACTUAL ROTATION SPEED IS 2-15% LESS THAN SYNCHRONOUS SPEED.

DECIMAL GEAR HEAD	GEAR HEAD MODEL	SPEED RANGE	L.SPEED 70rpm H.SPEED 1400rpm	REDUCTION RATIO											
				50Hz	60Hz	95	11.7	7.8	4.7	3.9	2.3	1.9	1.2	0.8	0.6
28DGN10Y	18GN□Y, S8GN□B	Low speed	0.9	1.5	2.2	3.6	4.4	6.6	7.9	12	18	24	100		
		High speed	4.7	7.8	11.7	19	23	35	42	63	94	100	100		
28DGN10Y	18GN□Y, S8GN□B	Low speed	0.9	1.5	2.2	3.6	4.4	6.6	7.9	12	18	24	100		
		High speed	4.7	7.8	11.7	19	23	35	42	63	94	100	100		
28DGN10Y	18GN□Y, S8GN□B	Low speed	1.0	1.7	2.6	4.3	5.1	7.7	9.2	100	100	100	100		
		High speed	5.5	9.2	14	23	28	42	50	100	100	100	100		
28DGN10Y	18GN□Y, S8GN□B	Low speed	1.0	1.7	2.6	4.3	5.1	7.7	9.2	100	100	100	100		
		High speed	5.5	9.2	14	23	28	42	50	100	100	100	100		

■ COLOR INDICATES THAT THE ROTATION OF GEARHEAD SHAFT IS IN OPPOSITE DIRECTION AS OUTPUT SHAFT OF MOTOR
D:USE DECIMAL GEAR

SPEED CONTROL INDUCTION MOTOR

MOTOR

N - T CURVE

MOTOR DIMENSIONS

PINION SHAFT

③ 9IN40S4□-V 9IN40P4□-V

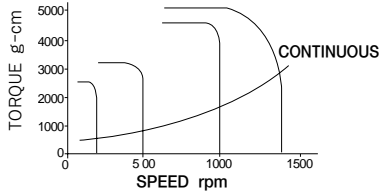

WEIGHT 2.6kg

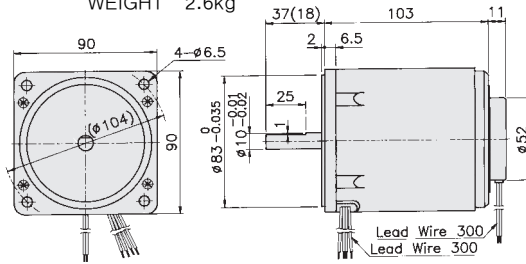

MODULE 0.6
PRESSURE ANGLE 20°
TEETH No. 12
DIAMETER ϕ 9.63mm
LENGTH 18mm

46

④ 9IF60S4□-V 9IF60P4□-V

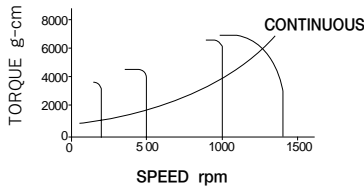

WEIGHT 2.9kg

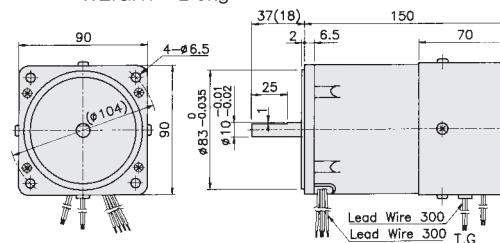

MODULE 0.6
PRESSURE ANGLE 20°
TEETH No. 12
DIAMETER ϕ 9.63mm
LENGTH 18mm

⑤ 9IF90S4□-V 9IF90E4□-V

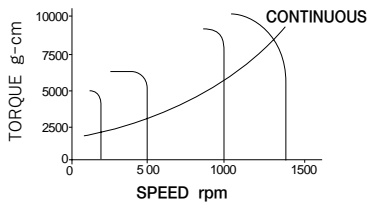

WEIGHT 3.5kg

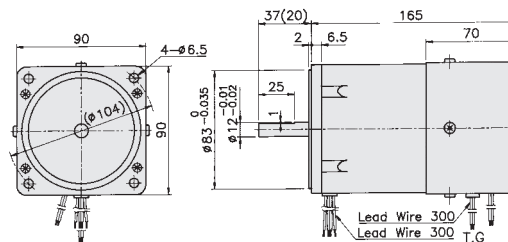

MODULE 0.8
PRESSURE ANGLE 20°
TEETH No. 11
DIAMETER ϕ 11.55mm
LENGTH 20mm

⑥ 9IF120S4□-V 9IF120E4□-V

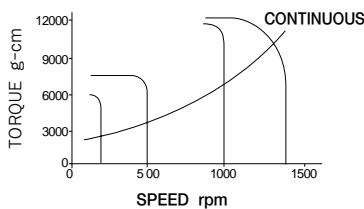

WEIGHT 3.5kg

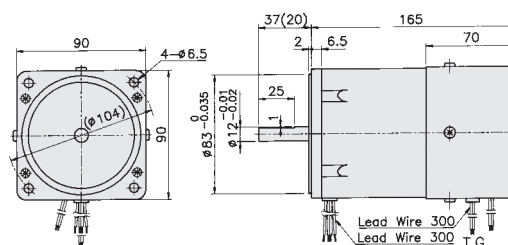

MODULE 0.8
PRESSURE ANGLE 20°
TEETH No. 11
DIAMETER ϕ 11.55mm
LENGTH 20mm

! Attention : As the model no. 9IF60S(P)4L(H)-V, 9IF90S(E)4L(H)-V, 9IF120S(E)4L(H)-V each has a fan motor inside, the black lead wire should be connected to the wire no. 1 and 2 of the controller (Refer to use only the controller model no.2290G)

◆ ELECTRICAL PERFORMANCES

- SINGLE PHASE, 4 POLES, CONTINUOUS DUTY, INSULATION CLASS "E"

FIG NO.	MODEL		MAXIMUM OUTPUT W	VOLTAGE V	FREQUENCY Hz	VARIABLE SPEED RANGE rpm	MAXIMUM CURRENT mA	STARTING TORQUE		ALLOWABLE TORQUE		CAPACITOR μ F
	STRAIGHT SHAFT	PINION SHAFT						kg-cm	N-m	kg-cm	N-m	
③	9IN40S4L-V	9IN40P4L-V	40	100	50 / 60	70~1400	1100	1.80	0.176	0.60~2.80	0.059~0.274	10
③	9IN40S4H-V	9IN40P4H-V	40	220	50 / 60	70~1400	600	1.80	0.176	0.60~2.80	0.059~0.274	2.0
④	9IF60S4L-V	9IF60P4L-V	60	100	50 / 60	70~1400	1300	3.00	0.294	1.20~3.70	0.118~0.363	16
④	9IF60S4H-V	9IF60P4H-V	60	220	50 / 60	70~1400	650	3.00	0.294	1.20~3.70	0.118~0.363	3.5
⑤	9IF90S4L-V	9IF90E4L-V	90	100	50 / 60	70~1400	2000	4.20	0.412	2.50~5.50	0.245~0.539	25
⑤	9IF90S4H-V	9IF90E4H-V	90	220	50 / 60	70~1400	1000	4.20	0.412	2.50~5.50	0.245~0.539	5
⑥	9IF120S4L-V	9IF120E4L-V	120	100	50 / 60	70~1400	2200	6.00	0.588	3.00~6.50	0.294~0.637	35
⑥	9IF120S4H-V	9IF120E4H-V	120	220	50 / 60	70~1400	1100	6.00	0.588	3.00~6.50	0.294~0.637	6

GEAR HEAD

DECIMAL GEAR HEAD (RATIO 1/10)

GEAR HEAD (RATIO 1/3~1/180)

④ 9DP10Y WEIGHT 0.6kg

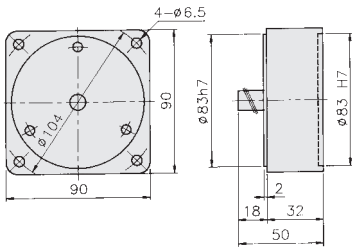

③ 9P□B
9P□Y

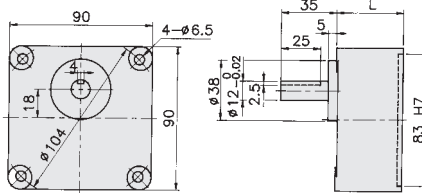

GEAR RATIO	mm L	WEIGHT(kg)	BOLT
1/3~1/18	42	0.8	M6×65
1/25~1/180	60	0.9	M6×80

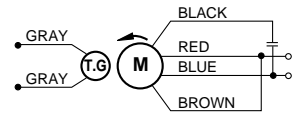
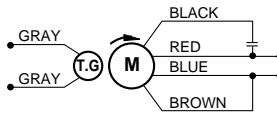
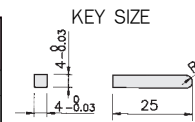

⑤ 9E□B

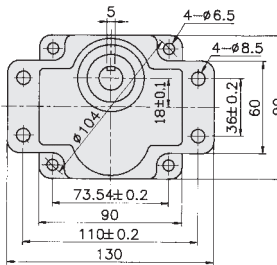

GEAR RATIO	mm L	WEIGHT(kg)	BOLT
1/3~1/60	65	1.6	M6×25
1/75~1/180	80	2.0	M6×25

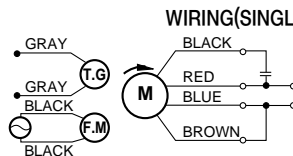
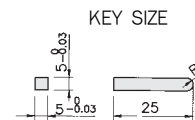

WIRING(SINGLE PHASE MOTOR)

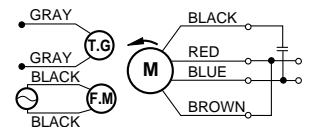

*Facing output shaft (60W~120W)

- ⊕ THE NORMAL TORQUE(kg·cm) IS THAT THE MOTOR & GEAR HEAD ARE DIRECTLY COUPLED.
- ⊕ INSERT THE DENOMINATOR OF REDUTION RATIO IN □ OF GEAR HEAD MODEL NAME.
- ⊕ ACTUAL ROTATION SPEED IS 2-15% LESS THAN SYNCHRONOUS SPEED.

DECIMAL GEAR HEAD	GEAR HEAD MODEL	SPEED RANGE DENOMINATOR OF REDUCTION RATIO	L.SPEED 70rpm																								
			H.SPEED 1400rpm																								
			95	11.7	7.8	4.7	3.9	2.3	1.9	1.2	0.8	0.6	0.4	389	233	156	93	78	47	39	23	16	12	8			
④9DP10Y	③9P□Y, 9P□B	Low speed	1.7	2.9	4.4	7.3	8.7	13	16	24	35	47	71	120	120	120	3	5	7.5	12.5	15	25	30	50	75	100	150
		High speed	8.2	14	20	34	41	61	73	110	120	120	120	120	120	120	3.6	6	9	15	18	30	36	60	90	120	180
④9DP10Y	③9P□Y, 9P□B	Low speed	1.7	2.9	4.4	7.3	8.7	13	16	24	35	47	71	120	120	120	3.5	5.8	8.7	15	17	26	31	47	71	94	120
		High speed	11	18	27	45	54	81	97	120	120	120	120	120	120	120	11	18	27	45	54	81	97	120	120	120	120
④9DP10Y	③9P□Y, 9P□B	Low speed	3.5	5.8	8.7	15	17	26	31	47	71	120	120	120	120	120	7.3	12	18	27	33	49	59	98	133	177	266
		High speed	11	18	27	45	54	81	97	120	120	120	120	120	120	120	16	27	40	60	72	108	130	217	292	300	300
	⑤9E□B	Low speed	7.3	12	18	27	33	49	59	98	133	177	266	300	300	300	7.3	12	18	27	33	49	59	98	133	177	266
		High speed	16	27	40	60	72	108	130	217	292	300	300	300	300	300	16	27	40	60	72	108	130	217	292	300	300
	⑤9E□B	Low speed	8.7	15	22	33	39	59	71	118	159	213	300	300	300	8.7	15	22	33	39	59	71	118	159	213	300	
		High speed	19	32	47	71	85	128	154	256	300	300	300	300	300	300	19	32	47	71	85	128	154	256	300	300	300

■ COLOR INDICATES THAT THE ROTATION OF GEARHEAD SHAFT IS IN OPPOSITE DIRECTION AS OUTPUT SHAFT OF MOTOR
D:USE DECIMAL GEAR

SPEED CONTROL REVERSIBLE MOTOR

MOTOR

N - T CURVE

MOTOR DIMENSIONS

PINION SHAFT

48

⑦ 8RN20S4□-V 8RN20GN4□-V

WEIGHT 1.6kg

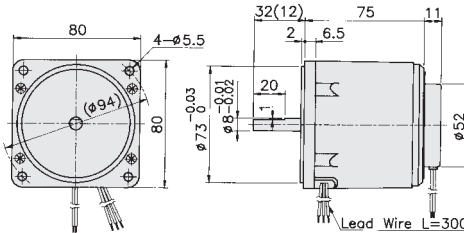
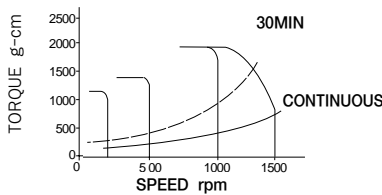

MODULE 0.5
PRESSURE ANGLE 20°
TEETH No. 10
DIAMETER ϕ 7.2mm
LENGTH 12mm

⑧ 8RN25S4□-V 8RN25GN4□-V

WEIGHT 1.7kg

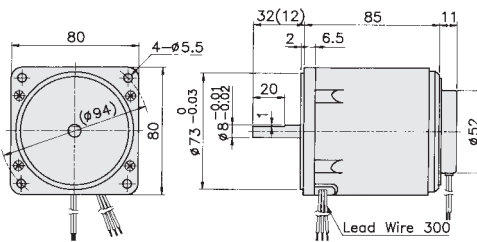
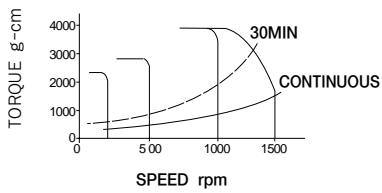

MODULE 0.5
PRESSURE ANGLE 20°
TEETH No. 10
DIAMETER ϕ 7.2mm
LENGTH 12mm



⊕ ELECTRICAL PERFORMANCES

- SINGLE PHASE, 4POLES, 30MIN, DUTY, INSULATION CLASS "E"

FIG NO.	MODEL		MAXIMUM OUTPUT W	VOLTAGE V	FREQUENCY Hz	VARIABLE SPEED RANGE rpm	MAXIMUM CURRENT mA	STARTING TORQUE		ALLOWABLE TORQUE		CAPACITOR μ F
	STRAIGHT SHAFT	PINION SHAFT						kg-cm	N-m	kg-cm	N-m	
⑦	8RN20S4L-V	8RN20GN4L-V	20	100	50 / 60	70~1400	550	1.04	0.102	0.30~1.6	0.039~0.176	8
⑦	8RN20S4H-V	8RN20GN4H-V	20	220	50 / 60	70~1400	270	1.04	0.102	0.30~1.6	0.039~0.176	1.5
⑧	8RN25S4L-V	8RN25GN4L-V	25	100	50 / 60	70~1400	800	1.28	0.125	0.35~1.9	0.059~0.255	10
⑧	8RN25S4H-V	8RN25GN4H-V	25	220	50 / 60	70~1400	410	1.28	0.125	0.35~1.9	0.059~0.255	2

GEAR HEAD

DECIMAL GEAR HEAD (RATIO 1/10)

GEAR HEAD (RATIO 1/3~1/180)

② 8DGN10Y WEIGHT 0.3kg

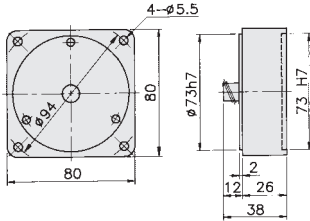

① 8GN□B
8GN□Y

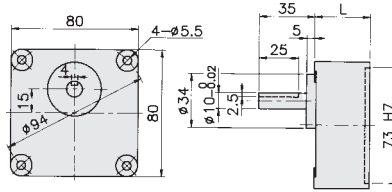

GEAR RATIO	mm L	WEIGHT(kg)	BOLT
1/3~1/18	30	0.5	M5×50
1/25~1/180	40	0.6	M5×60

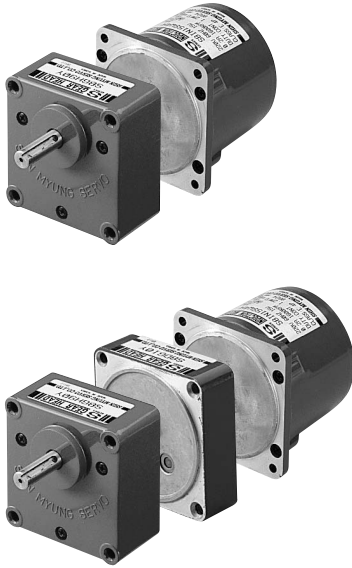
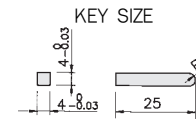

WIRING(SINGLE PHASE MOTOR)

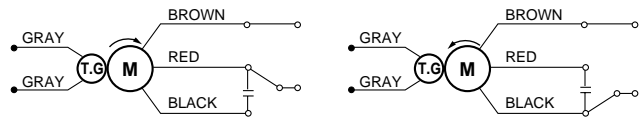

* Facing output shaft

- ⊕ THE NORMAL TORQUE(kg·cm) IS THAT THE MOTOR & GEAR HEAD ARE DIRECTLY COUPLED.
- ⊕ INSERT THE DENOMINATOR OF REDUCTION RATIO IN □ OF GEAR HEAD MODEL NAME.
- ⊕ ACTUAL ROTATION SPEED IS 2-15% LESS THAN SYNCHRONOUS SPEED.

DECIMAL GEAR HEAD	GEAR HEAD MODEL	SPEED RANGE	L.SPEED 70rpm H.SPEED 1400rpm	REDUCTION RATIO											
				95	11.7	7.8	4.7	3.9	2.3	1.9	1.2	0.8	0.6	0.4	
②8DGN10Y	①8GN□Y, 8GN□B	50Hz	3	5	7.5	12.5	15	25	30	50	75	100	150		
		60Hz	3.6	6	9	15	18	30	36	60	90	120	180		
②8DGN10Y	①8GN□Y, 8GN□B	Low speed	1.2	1.9	2.9	4.9	5.8	8.7	10	16	24	31	47		
		High speed	5.2	8.7	13	22	26	39	47	71	100	100	100		
②8DGN10Y	①8GN□Y, 8GN□B	Low speed	1.2	1.9	2.9	4.9	5.8	8.7	10	16	24	31	47		
		High speed	5.2	8.7	13	22	26	39	47	71	100	100	100		
②8DGN10Y	①8GN□Y, 8GN□B	Low speed	1.7	2.9	4.4	7.3	8.7	13	16	24	35	47	71		
		High speed	7.6	13	19	32	38	57	68	100	100	100	100		
②8DGN10Y	①8GN□Y, 8GN□B	Low speed	1.7	2.9	4.4	7.3	8.7	13	16	24	35	47	71		
		High speed	7.6	13	19	32	38	57	68	100	100	100	100		

■ COLOR INDICATES THAT THE ROTATION OF GEARHEAD SHAFT IS IN OPPOSITE DIRECTION AS OUTPUT SHAFT OF MOTOR
D:USE DECIMAL GEAR

SPEED CONTROL REVERSIBLE MOTOR

MOTOR

N - T CURVE

MOTOR DIMENSIONS

PINION SHAFT

⑨ 9RN40S4□-V 9RN40P4□-V

WEIGHT 2.6kg

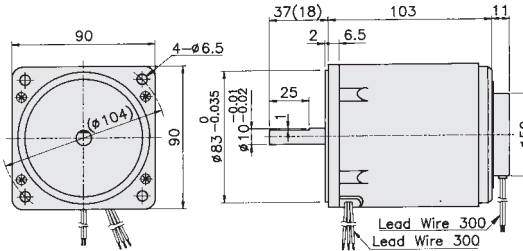
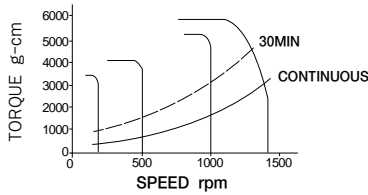

MODULE 0.6
PRESSURE ANGLE 20°
TEETH No. 12
DIAMETER φ9.63mm
LENGTH 18mm

⑩ 9RN60S4□-V 9RN60E4□-V

WEIGHT 2.7kg

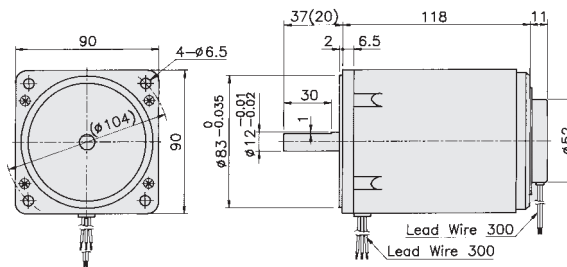
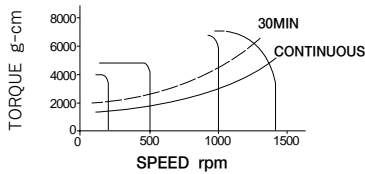

MODULE 0.8
PRESSURE ANGLE 20°
TEETH No. 11
DIAMETER φ11.55mm
LENGTH 20mm

⑪ 9RF90S4□-V 9RF90E4□-V

WEIGHT 3.5kg

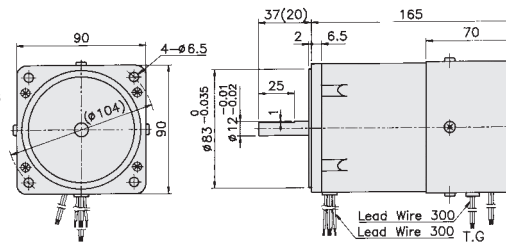
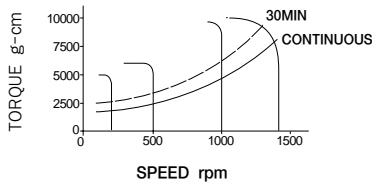

MODULE 0.8
PRESSURE ANGLE 20°
TEETH No. 11
DIAMETER φ11.55mm
LENGTH 20mm

⑫ 9RF120S4□-V 9RF120E4□-V

WEIGHT 3.5kg

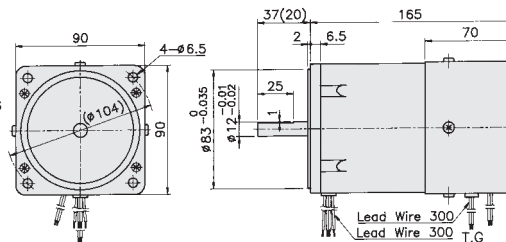
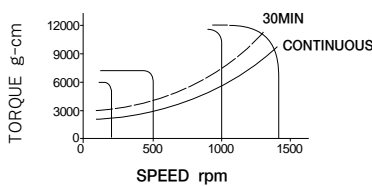

MODULE 0.8
PRESSURE ANGLE 20°
TEETH No. 11
DIAMETER φ11.55mm
LENGTH 20mm

50

⊕ ELECTRICAL PERFORMANCES

- SINGLE PHASE, 4 POLES, 30MIN. DUTY, INSULATION CLASS "E"

FIG NO.	MODEL		MAXIMUM OUTPUT W	VOLTAGE V	FREQUENCY Hz	VARIABLE SPEED RANGE rpm	MAXIMUM CURRENT mA	STARTING TORQUE		ALLOWABLE TORQUE		CAPACITOR μF
	STRAIGHT SHAFT	PINION SHAFT						kg-cm	N-m	kg-cm	N-m	
⑨	9RN40S4L-V	9RN40P4L-V	40	100	50 / 60	70~1400	1300	2.60	0.255	0.65~3.00	0.064~0.294	16
⑨	9RN40S4H-V	9RN40P4H-V	40	220	50 / 60	70~1400	650	2.60	0.255	0.65~3.00	0.064~0.294	3.5
⑩	9RN60S4L-V	9RN60E4L-V	60	100	50 / 60	70~1400	1800	3.00	0.294	1.20~3.70	0.118~0.363	25
⑩	9RN60S4H-V	9RN60E4H-V	60	220	50 / 60	70~1400	900	3.00	0.294	1.20~3.70	0.118~0.363	5
⑪	9RF90S4L-V	9RF90E4L-V	90	100	50 / 60	70~1400	2200	4.20	0.412	2.50~5.50	0.245~0.539	25
⑪	9RF90S4H-V	9RF90E4H-V	90	220	50 / 60	70~1400	1100	4.20	0.412	2.50~5.50	0.245~0.539	5
⑫	9RF120S4L-V	9RF120E4L-V	120	100	50 / 60	70~1400	2200	6.00	0.588	3.00~6.50	0.294~0.637	35
⑫	9RF120S4H-V	9RF120E4H-V	120	220	50 / 60	70~1400	1100	6.00	0.588	3.00~6.50	0.294~0.637	7

GEAR HEAD

DECIMAL GEAR HEAD (RATIO 1/10)

GEAR HEAD (RATIO 1/3~1/180)

④ 9DP10Y

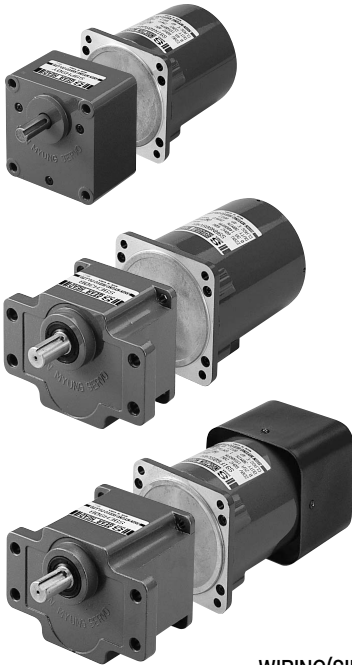
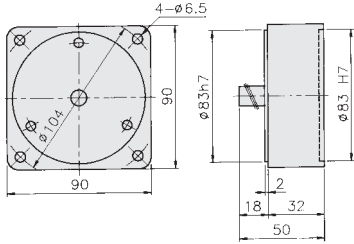

③ 9P□B 9P□Y

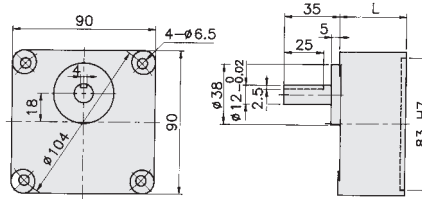

GEAR RATIO	L mm	WEIGHT(kg)	BOLT
1/3~1/18	42	0.8	M6×65
1/25~1/180	60	0.9	M6×80

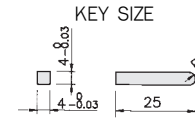

⑤ 9E□B

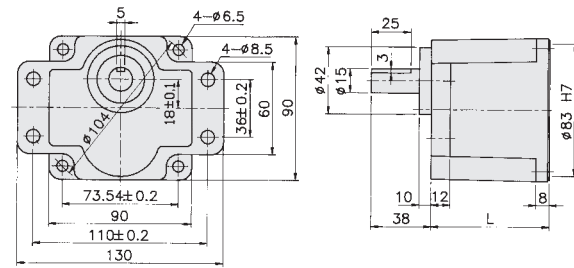

GEAR RATIO	L mm	WEIGHT(kg)	BOLT
1/3~1/60	65	1.6	M6×25
1/75~1/180	80	2.0	M6×25

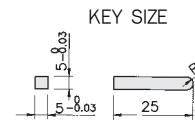

WIRING(SINGLE PHASE MOTOR)

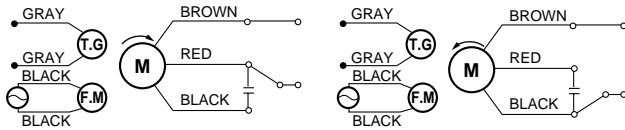

*Facing output shaft (90W~120W)

WIRING(SINGLE PHASE MOTOR)

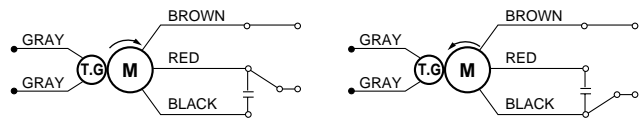

*Facing output shaft (S9RN type)

⊕ THE NORMAL TORQUE(kg·cm) IS THAT THE MOTOR & GEAR HEAD ARE DIRECTLY COUPLED.

⊕ INSERT THE DENOMINATOR OF REDUCTION RATIO IN □ OF GEAR HEAD MODEL NAME.

⊕ ACTUAL ROTATION SPEED IS 2-15% LESS THAN SYNCHRONOUS SPEED.

DECIMAL GEAR HEAD	GEAR HEAD MODEL	SPEED RANGE	L.SPEED 70rpm															
			H.SPEED 1400rpm															
			50Hz															
			60Hz															
④9DP10Y	③9P□Y, 9P□YB	Low speed	1.9	3.2	4.7	7.9	9.5	14	17	26	38	51	77					
		High speed	8.7	15	22	36	44	66	79	118	120	120	120					
④9DP10Y	③9P□Y, S9P□YB	Low speed	1.9	3.2	4.7	7.9	9.5	14	17	26	38	51	77					
		High speed	8.7	15	22	36	44	66	79	118	120	120	120					
—	⑤9E□B	Low speed	3.5	5.8	8.7	13	16	24	28	47	64	85	128					
		High speed	11	18	27	40	49	73	87	146	197	262	300					
—	⑤9E□B	Low speed	3.5	5.8	8.7	13	16	24	28	47	64	85	128					
		High speed	11	18	27	40	49	73	87	146	197	262	300					
—	⑤9E□B	Low speed	7.3	12	18	27	33	49	59	98	133	177	266					
		High speed	16	27	40	60	72	108	130	217	292	300	300					
—	⑤9E□B	Low speed	7.3	12	18	27	33	49	59	98	133	177	266					
		High speed	16	27	40	60	72	108	130	217	292	300	300					
—	⑤9E□B	Low speed	8.7	15	22	33	39	59	71	118	159	213	300					
		High speed	19	32	47	71	85	128	154	256	300	300	300					
—	⑤9E□B	Low speed	8.7	15	22	33	39	59	71	118	159	213	300					
		High speed	19	32	47	71	85	128	154	256	300	300	300					

■ COLOR INDICATES THAT THE ROTATION OF GEARHEAD SHAFT IS IN OPPOSITE DIRECTION AS OUTPUT SHAFT OF MOTOR
D:USE DECIMAL GEAR

SPEED CONTROLLER

FOR SPEED CONTROL MOTOR

The speed control equipments are used for small AC motor on which tachogenerator is attached. It checks the rotation speed of motor with tachogenerator and compare with the fixed rotation speed. Therefore, it is the closed Loop control method for keeping the stable speed range from low to high.

1. SPECIFICATION

Item	SC-1190G	SC-2290G	MC100V	MC220V	MC100DN	MC220DN
Input Voltage	110VAC+10%	220VAC+10%	110VAC+10%	220VAC+10%	110VAC+10%	220VAC+10%
Speed Control Range	70~1400 rpm		90~1700rpm			
Applicable Motor Output	15W~90W(T. G. Attached)		15W~120W		15W~1800W	
Remote Control	Available		Not Available		Available	
Control Method	Analog		Analog		Digital	
Soft Run Function	×	×	×	×	○	○

2. DIMENSION

1) SC-1190G, SC-2290G

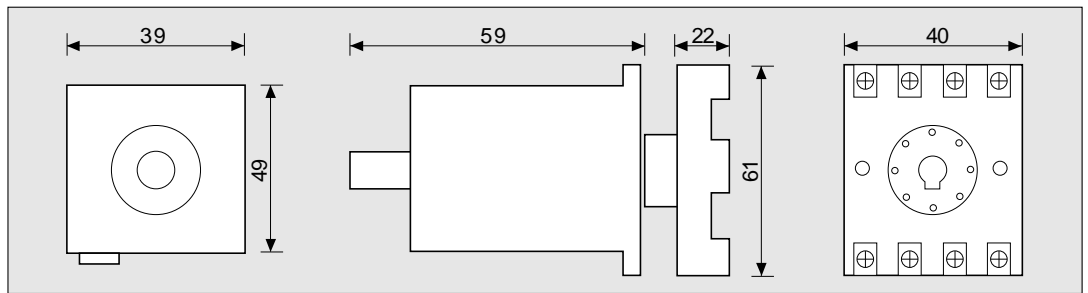

2) MC100V, MC220V

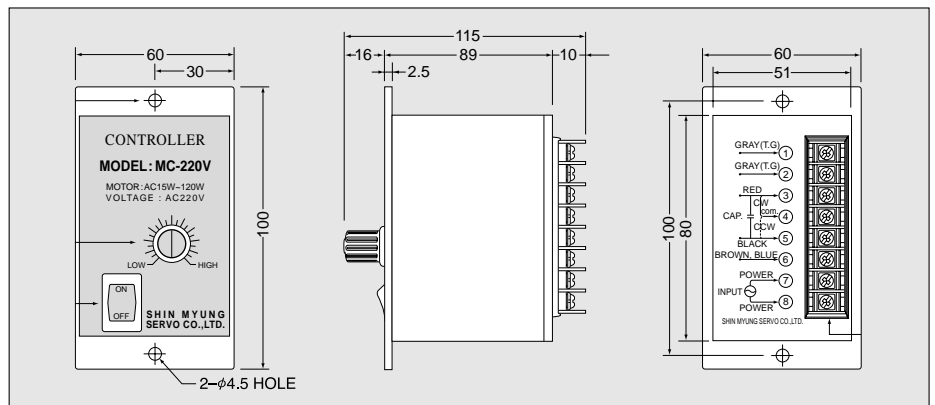

3) MC100DN, MC220DN

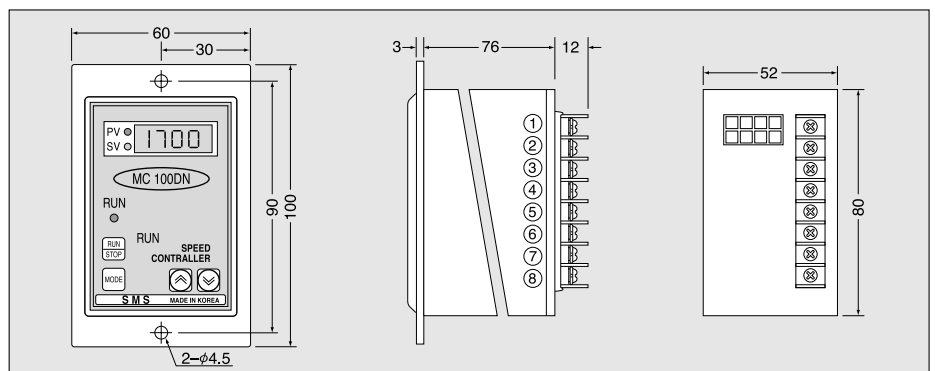

SPEED CONTROLLER

FOR SPEED CONTROL MOTOR

3. WIRING

1) SC-1190G, SC-2290G

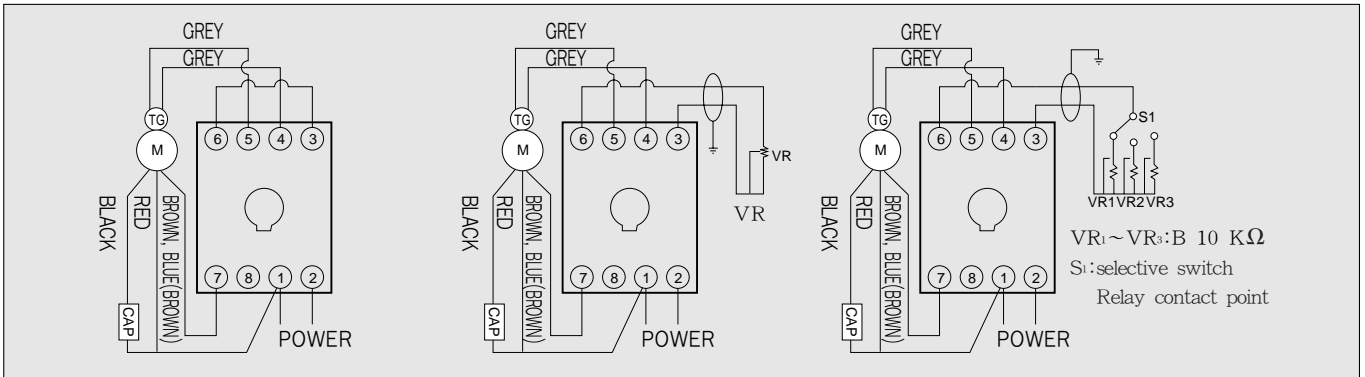

* (Brown)Apply Reversible Motor
(universal wiring)

* (Brown)Apply Reversible Motor
* Locate KNOB in minimum
(remote control)

* (Brown)Apply Reversible Motor
* Locate KNOB in minimum
(stepped speed control)

- Ret. 1. The wiring makes the rotation in the same direction of watch from the side of the motor's output.
2. For the opposite direction of rotation, the wiring between Red and Blue or between Brown and Black should be changed each other in the induction motor. And the Red line and Black line must be changed for the wiring in the reversible motor.

2) MC100V, MC220V

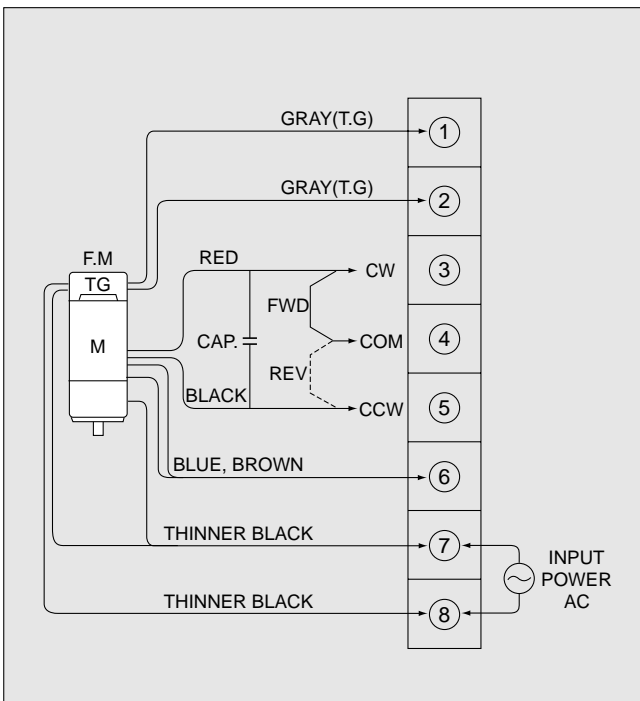

3) MC100DN, MC220DN

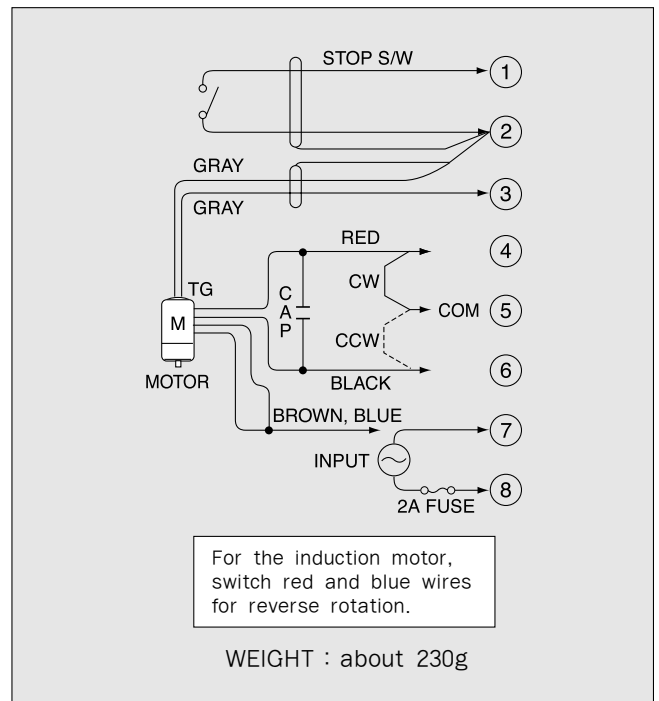

MAGNETIC BRAKE INDUCTION MOTOR

MOTOR

N - T CURVE

MOTOR DIMENSIONS

PINION SHAFT

54

① 8IN15S4□-B 8IN15GN4□-B

WEIGHT 1.7kg

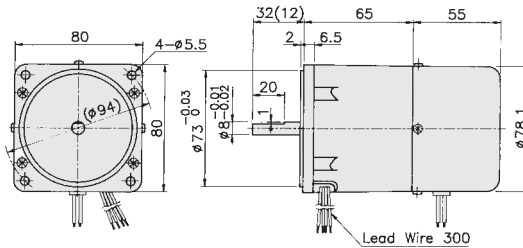
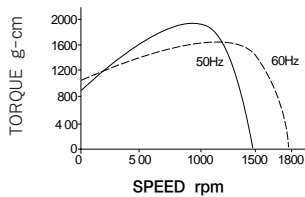

MODULE 0.5
PRESSURE ANGLE 20°
TEETH No. 10
DIAMETER ϕ 7.2mm
LENGTH 12mm

② 8IN25S4□-B 8IN25GN4□-B

WEIGHT 1.8kg

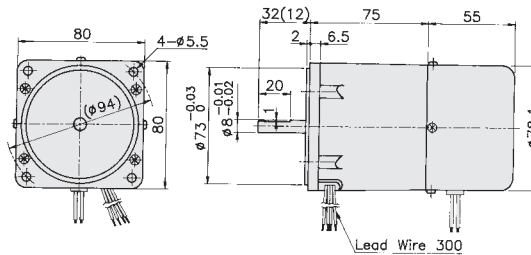
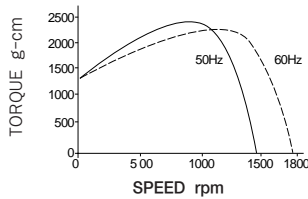

MODULE 0.5
PRESSURE ANGLE 20°
TEETH No. 10
DIAMETER ϕ 7.2mm
LENGTH 12mm



⊕ ELECTRICAL PERFORMANCES

- SINGLE PHASE, 4 POLES, CONTINUOUS DUTY, INSULATION CLASS "E"

FIG NO.	MODEL		OUTPUT W	VOLTAGE V	FREQUENCY Hz	RATED					STARTING		STARTING CURRENT mA	CAPACITOR μ F	BRAKE		BRAKE CURRENT mA
						SPEED rpm	INPUT W	CURRENT mA	TORQUE		TORQUE				TORQUE		
	kg-cm	N-m							kg-cm	N-m	kg-cm	N-m					
①	8IN15S4L-B	8IN15GN4L-B	15	100	50	1250	45	400	1.10	0.108	0.68	0.067	800	3	0.10	0.010	100
						1550	45	400	0.90	0.088	0.68	0.67	750				
①	8IN15S4H-B	8IN15GN4H-B	15	220	50	1250	45	200	1.10	0.108	0.68	0.067	400	1.2	0.10	0.010	100
						1550	45	200	0.90	0.088	0.68	0.67	400				
②	8IN25S4L-B	8IN25GN4L-B	25	100	50	1250	60	600	1.75	0.172	1.00	0.098	1100	6	0.10	0.010	100
						1550	60	600	1.40	0.137	1.00	0.098	1000				
②	8IN25S4H-B	8IN25GN4H-B	25	220	50	1250	60	290	1.75	0.172	1.00	0.098	500	1.5	0.10	0.010	100
						1550	60	290	1.40	0.137	1.00	0.098	500				

GEAR HEAD

DECIMAL GEAR HEAD (RATIO 1/10)

GEAR HEAD (RATIO 1/3~1/180)

2 8DGN10Y WEIGHT 0.3kg

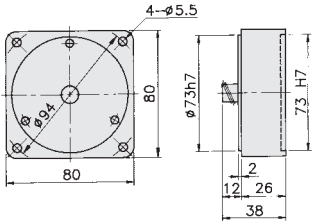

1 8GN□B
8GN□Y

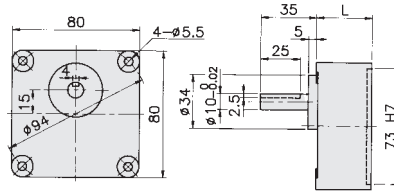

GEAR RATIO	mm L	WEIGHT(kg)	BOLT
1/3~1/18	30	0.5	M5×50
1/25~1/180	40	0.6	M5×60

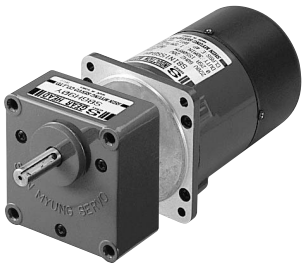
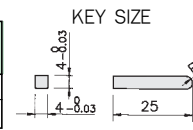

WIRING(SINGLE PHASE MOTOR)

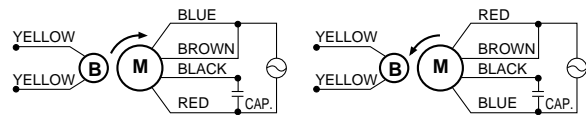

*Facing output shaft

- ⊕ THE NORMAL TORQUE(kg·cm) IS THAT THE MOTOR & GEAR HEAD ARE DIRECTLY COUPLED.
- ⊕ INSERT THE DENOMINATOR OF REDUCTION RATIO IN □ OF GEAR HEAD MODEL NAME.
- ⊕ ACTUAL ROTATION SPEED IS 2-15% LESS THAN SYNCHRONOUS SPEED.

DECIMAL GEAR HEAD	GEAR HEAD MODEL	SYNCHRONOUS SPEED (RPM)		500	300	200	120	100	60	50	30	20	15	10	6	5	3	2	1
		DENOMINATOR OF REDUCTION RATIO	50Hz	3	5	7.5	12.5	15	25	30	50	75	100	150	250	300	500	750	1500
			60Hz	3.6	6	9	15	18	30	36	60	90	120	180	300	360	600	900	1800
28DGN10Y	18GN□Y, 8GN□B		2.6	4.4	6.6	11	13	20	24	35	53	71	100	D35	D35	D65	D80	D100	
28DGN10Y	18GN□Y, 8GN□B		2.6	4.4	6.6	11	13	20	24	35	53	71	100	D35	D35	D65	D80	D100	
28DGN10Y	18GN□Y, 8GN□B		4.1	6.8	10	17	20	31	37	55	83	110	100	D35	D35	D65	D80	D100	
28DGN10Y	18GN□Y, 8GN□B		4.1	6.8	10	17	20	31	37	55	83	110	100	D35	D35	D65	D80	D100	

■ COLOR INDICATES THAT THE ROTATION OF GEARHEAD SHAFT IS IN OPPOSITE DIRECTION AS OUTPUT SHAFT OF MOTOR
D:USE DECIMAL GEAR

MAGNETIC BRAKE INDUCTION MOTOR

MOTOR

N - T CURVE

MOTOR DIMENSIONS

PINION SHAFT

③ 9IN40S4□-B 9IN40P4□-B

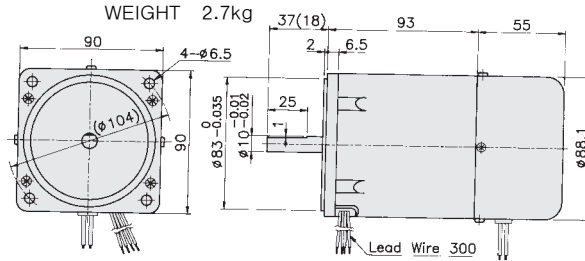
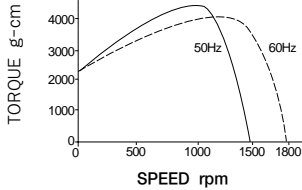

MODULE	0.6
PRESSURE ANGLE	20°
TEETH No.	12
DIAMETER	ø 9.63mm
LENGTH	18mm

56

④ 9IF60S4□-B 9IF60P4□-B

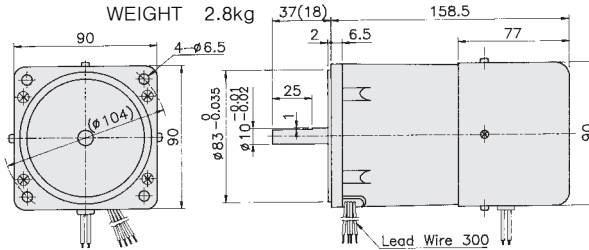
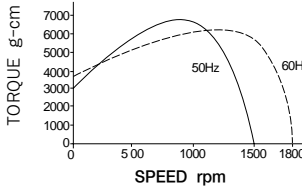

MODULE	0.6
PRESSURE ANGLE	20°
TEETH No.	12
DIAMETER	ø 9.63mm
LENGTH	18mm

⑤ 9IF90S4□-B 9IF90E4□-B

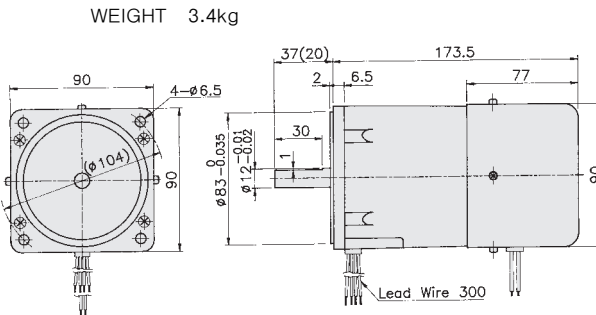
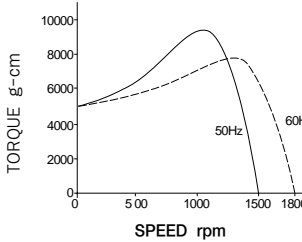

MODULE	0.8
PRESSURE ANGLE	20°
TEETH No.	11
DIAMETER	ø 11.55mm
LENGTH	20mm

⑥ 9IF120S4□-B 9IF120E4□-B

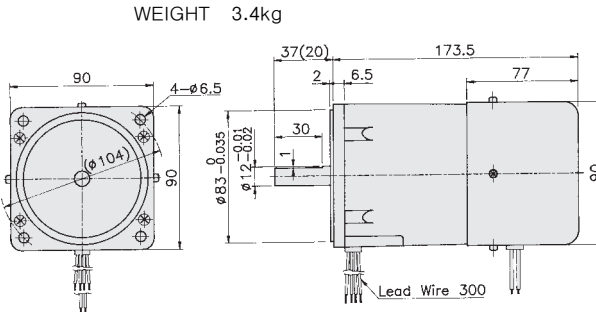
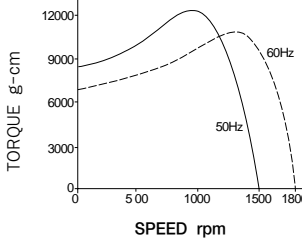

MODULE	0.8
PRESSURE ANGLE	20°
TEETH No.	11
DIAMETER	ø 11.55mm
LENGTH	20mm

⊕ ELECTRICAL PERFORMANCES

- SINGLE PHASE, 4 POLES, CONTINUOUS DUTY, INSULATION CLASS "E"

FIG NO.	MODEL		OUTPUT W	VOLTAGE V	FREQUENCY Hz	RATED				STARTING TORQUE		STARTING CURRENT mA	CAPACITOR μF	BRAKE TORQUE		BRAKE CURRENT mA	
	STRAIGHT SHAFT	PINION SHAFT				SPEED rpm	INPUT W	CURRENT mA	TORQUE		kg-cm			N-m	kg-cm		N-m
								kg-cm	N-m								
③	9IN40S4L-B	9IN40P4L-B	40	100	50	1250	110	1100	3.00	0.294	1.80	0.176	1700	10	0.10	0.010	100
					60	1550	110	1100	2.50	0.245	1.80	0.176	1600				
③	9IN40S4H-B	9IN40P4H-B	40	220	50	1250	110	520	3.00	0.294	1.80	0.176	1100	2	0.10	0.010	100
					60	1550	110	520	2.50	0.245	1.80	0.176	1100				
④	9IF60S4L-B	9IF60P4L-B	60	100	50	1250	150	1300	4.50	0.441	3.00	0.294	2200	16	0.10	0.010	100
					60	1550	150	1300	3.80	0.372	3.00	0.294	2200				
④	9IF60S4H-B	9IF60P4H-B	60	220	50	1250	150	700	4.50	0.441	3.00	0.294	1300	3.5	0.10	0.010	100
					60	1550	150	700	3.80	0.372	3.00	0.294	1300				
⑤	9IF90S4L-B	9IF90E4L-B	90	100	50	1250	200	2000	6.80	0.666	4.20	0.412	3200	25	0.10	0.010	100
					60	1550	200	2000	5.70	0.559	4.20	0.412	3000				
⑤	9IF90S4H-B	9IF90E4H-B	90	220	50	1250	200	1000	6.80	0.666	4.20	0.412	1600	5	0.10	0.010	100
					60	1550	200	1000	5.70	0.559	4.20	0.412	1500				
⑥	9IF120S4L-B	9IF120E4L-B	120	100	50	1300	240	2400	8.70	0.853	5.40	0.549	4800	35	0.10	0.010	100
					60	1600	240	2400	7.30	0.715	5.40	0.549	4600				
⑥	9IF120S4H-B	9IF120E4H-B	120	220	50	1300	350	1600	8.70	0.853	5.40	0.549	3200	6	0.10	0.010	100
					60	1600	350	1600	7.30	0.715	5.40	0.549	3200				

GEAR HEAD

DECIMAL GEAR HEAD (RATIO 1/10)

GEAR HEAD (RATIO 1/3~1/180)

4 9DP10Y

WEIGHT 0.6kg

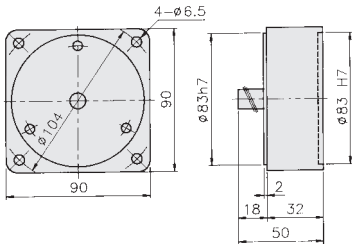

3 9P□B 9P□Y

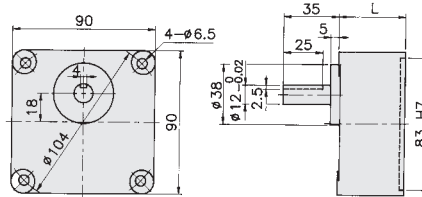

GEAR RATIO	mm L	WEIGHT(kg)	BOLT
1/3~1/18	42	0.8	M6×65
1/25~1/180	60	0.9	M6×80

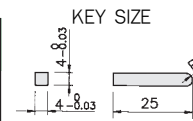

5 9E□B

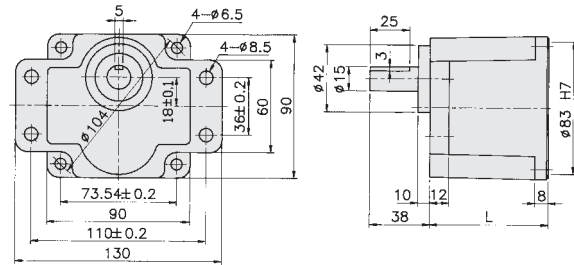

GEAR RATIO	mm L	WEIGHT(kg)	BOLT
1/3~1/60	65	1.6	M6×25
1/75~1/180	85	2.0	M6×25

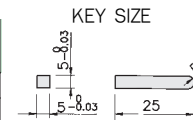

WIRING(SINGLE PHASE MOTOR)

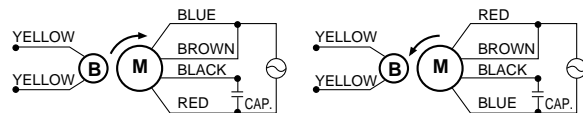

* Facing output shaft

- ⊕ THE NORMAL TORQUE(kg·cm) IS THAT THE MOTOR & GEAR HEAD ARE DIRECTLY COUPLED.
- ⊕ INSERT THE DENOMINATOR OF REDUTION RATIO IN □ OF GEAR HEAD MODEL NAME.
- ⊕ ACTUAL ROTATION SPEED IS 2-15% LESS THAN SYNCHRONOUS SPEED.

DECIMAL GEAR HEAD	GEAR HEAD MODEL	SYNCHRONOUS SPEED (RPM)		500	300	200	120	100	60	50	30	20	15	10	6	5	3	2	1
		DENOMINATOR OF REDUCTION RATIO	50Hz	3	5	7.5	12.5	15	25	30	50	75	100	150	250	300	500	750	1500
			60Hz	3.6	6	9	15	18	30	36	60	90	120	180	300	360	600	900	1800
4 9DP10Y	3 9P□Y, 9P□B		7.3	12	18	30	36	55	66	98	120	120	120	D120	D120	D120	D120	D120	D120
4 9DP10Y	3 9P□Y, 9P□B		7.3	12	18	30	36	55	66	98	120	120	120	D120	D120	D120	D120	D120	D120
4 9DP10Y	3 9P□Y, 9P□B		11	18	28	46	55	83	100	120	120	120	120	D120	D120	D120	D120	D120	D120
4 9DP10Y	3 9P□Y, 9P□B		11	18	28	46	55	83	100	120	120	120	120	D120	D120	D120	D120	D120	D120
—	5 9E□B		17	28	42	62	75	112	135	224	300	300	300	-	-	-	-	-	-
—	5 9E□B		17	28	42	62	75	112	135	224	300	300	300	-	-	-	-	-	-
	5 9E□B		21	35	53	80	96	144	172	287	300	300	300	-	-	-	-	-	-
	5 9E□B		21	35	53	80	96	144	172	287	300	300	300	-	-	-	-	-	-

■ COLOR INDICATES THAT THE ROTATION OF GEARHEAD SHAFT IS IN OPPOSITE DIRECTION AS OUTPUT SHAFT OF MOTOR
D:USE DECIMAL GEAR

MAGNETIC BRAKE INDUCTION MOTOR

MOTOR

N - T CURVE

MOTOR DIMENSIONS

PINION SHAFT

58

⑦ 9IN40S4J-B 9IN40P4J-B

WEIGHT 2.7kg

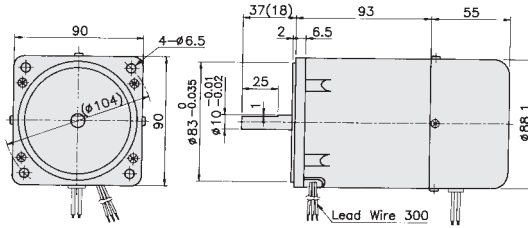
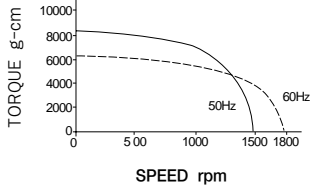

MODULE	0.6
PRESSURE ANGLE	20°
TEETH No.	12
DIAMETER	φ9.63mm
LENGTH	18mm

⑧ 9IF60S4J-B 9IF90E4J-B

WEIGHT 2.8kg

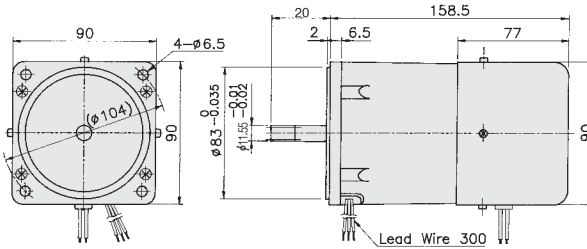
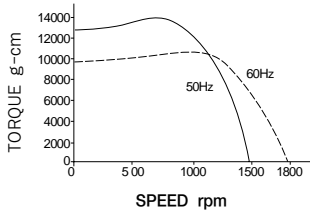

MODULE	0.8
PRESSURE ANGLE	20°
TEETH No.	11
DIAMETER	φ11.55mm
LENGTH	20mm

⑨ 9IF90S4J-B 9IF90E4J-B

WEIGHT 3.4kg

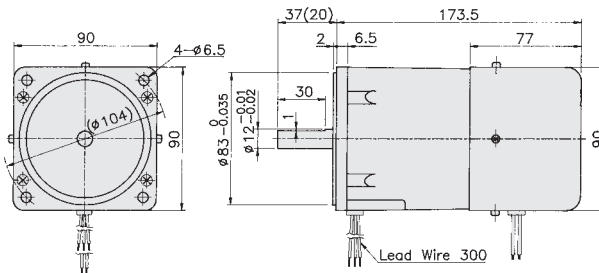
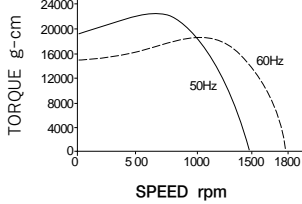

MODULE	0.8
PRESSURE ANGLE	20°
TEETH No.	11
DIAMETER	φ11.55mm
LENGTH	20mm

⑩ 9IF120S4J-B 9IF120E4J-B

WEIGHT 3.4kg

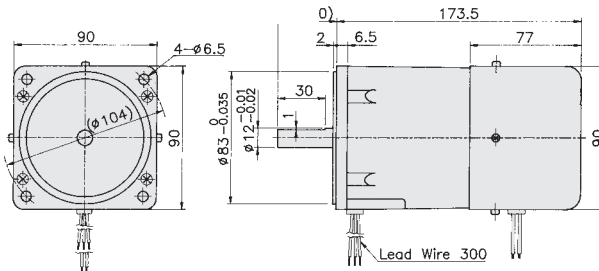
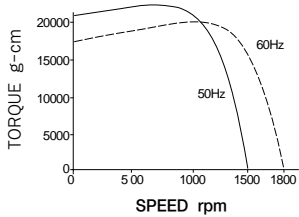

MODULE	0.8
PRESSURE ANGLE	20°
TEETH No.	11
DIAMETER	φ11.55mm
LENGTH	20mm

◆ ELECTRICAL PERFORMANCES

- THREE PHASE, 4 POLES, CONTINUOUS DUTY, INSULATION CLASS "E"

FIG NO.	MODEL		OUTPUT W	VOLTAGE V	FREQUENCY Hz	RATED				STARTING TORQUE		BRAKE TORQUE		BRAKE CURRENT mA	
	STRAIGHT SHAFT	PINION SHAFT				SPEED rpm	INPUT W	CURRENT mA	TORQUE		TORQUE				
									kg-cm	N-m	kg-cm	N-m			
⑦	9IN40S4J-B	9IN40P4J-B	40	220	50	1300	90	400	3.00	0.294	6.50	0.637	0.10	0.010	100
					60	1550	90	400	2.60	0.255	5.00	0.490			
⑧	9IF60S4J-B	9IF60E4J-B	60	220	50	1300	135	600	4.50	0.441	7.50	0.735	0.10	0.010	100
					60	1550	135	600	3.80	0.372	6.00	0.588			
⑨	9IF90S4J-B	9IF90E4J-B	90	220	50	1250	180	800	6.80	0.666	8.50	0.833	0.10	0.010	100
					60	1500	180	800	5.70	0.559	7.00	0.686			
⑩	9IF120S4J-B	9IF120E4J-B	120	220	50	1300	240	1000	9.00	0.882	16.00	1.568	0.10	0.010	100
					60	1550	240	1000	7.60	0.745	14.00	1.372			

GEAR HEAD

DECIMAL GEAR HEAD (RATIO 1/10) GEAR HEAD (RATIO 1/3~1/180)

④ 9DP10Y WEIGHT 0.6kg

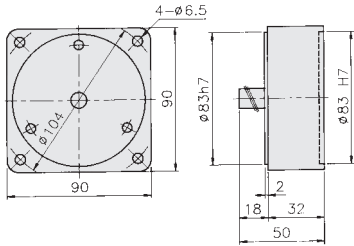

③ 9P□B
9P□Y

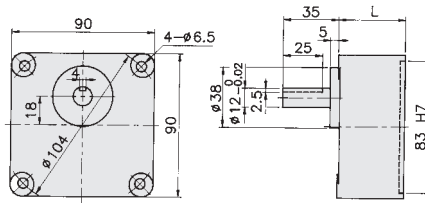

GEAR RATIO	mm L	WEIGHT(kg)	BOLT
1/3~1/18	42	0.8	M6×65
1/25~1/180	60	0.9	M6×80

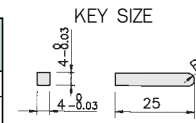

⑤ 9E□B

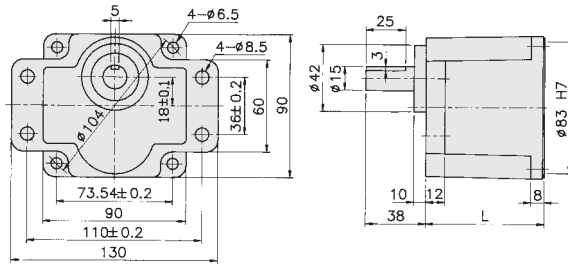

GEAR RATIO	mm L	WEIGHT(kg)	BOLT
1/3~1/60	65	1.6	M6×25
1/75~1/180	85	2.0	M6×25

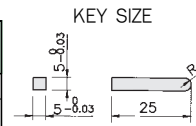

WIRING(THREE PHASE MOTOR)

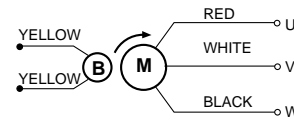

*Facing output shaft

For CCW rotation, Switch any 2 wires of U.V.W shown above.

- ⊕ THE NORMAL TORQUE(kg·cm) IS THAT THE MOTOR & GEAR HEAD ARE DIRECTLY COUPLED.
- ⊕ INSERT THE DENOMINATOR OF REDUTION RATIO IN □ OF GEAR HEAD MODEL NAME.
- ⊕ ACTUAL ROTATION SPEED IS 2-15% LESS THAN SYNCHRONOUS SPEED.

DECIMAL GEAR HEAD	GEAR HEAD MODEL	SYNCHRONOUS SPEED (RPM)																
		DENOMINATOR OF REDUCTION RATIO	500	300	200	120	100	60	50	30	20	15	10	6	5	3	2	1
			50Hz	3	5	7.5	12.5	15	25	30	50	75	100	150	250	300	500	750
④ 9DP10Y	③ 9P□Y, 9P□B	60Hz	3.6	6	9	15	18	30	36	60	90	120	180	300	360	600	900	1800
—	⑤ 9E□B		7.6	13	19	32	38	57	68	102	120	120	D120	D120	D120	D120	D120	
—	⑤ 9E□B		11	18	28	42	50	75	90	150	202	269	300	-	-	-	-	-
—	⑤ 9E□B		17	28	42	62	75	112	135	224	300	300	300	-	-	-	-	-
—	⑤ 9E□B		22	37	55	83	100	150	180	299	300	300	300	-	-	-	-	-

■ COLOR INDICATES THAT THE ROTATION OF GEARHEAD SHAFT IS IN OPPOSITE DIRECTION AS OUTPUT SHAFT OF MOTOR
D:USE DECIMAL GEAR

MAGNETIC BRAKE REVERSIBLE MOTOR

MOTOR

N - T CURVE

MOTOR DIMENSIONS

PINION SHAFT

⑪ 8RN20S4□-B 8RN20GN4□-B

WEIGHT 1.7kg

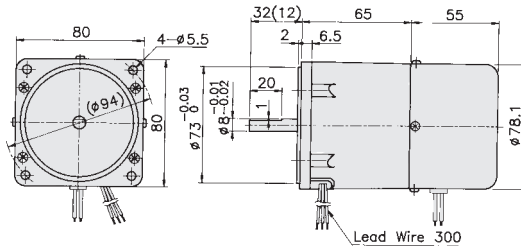
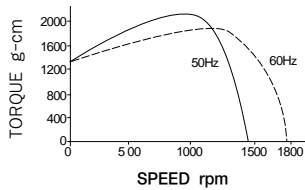

MODULE 0.5
PRESSURE ANGLE 20°
TEETH No. 10
DIAMETTER ϕ 7.2mm
LENGTH 12mm

⑫ 8RN25S4□-B 8RN25GN4□-B

WEIGHT 1.8kg

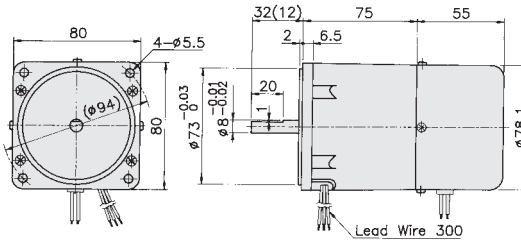
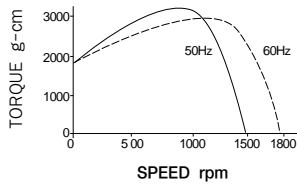

MODULE 0.5
PRESSURE ANGLE 20°
TEETH No. 10
DIAMETTER ϕ 7.2mm
LENGTH 12mm

⑬ 9RN40S4□-B 9RN40P4□-B

WEIGHT 2.7kg

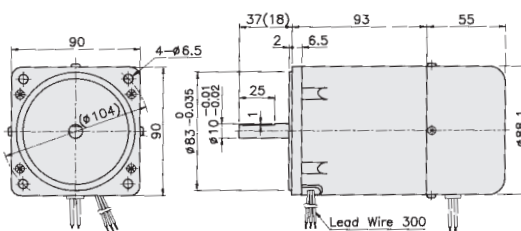
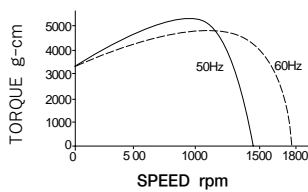

MODULE 0.6
PRESSURE ANGLE 20°
TEETH No. 12
DIAMETTER ϕ 9.63mm
LENGTH 18mm

⊕ ELECTRICAL PERFORMANCES

- SINGLE PHASE, 4 POLES, 30MIN, DUTY, INSULATION CLASS "E"

FIG NO.	MODEL		OUTPUT W	VOLTAGE V	FREQUENCY Hz	RATED					STARTING		CAPACITOR μ F	BRAKE		BRAKE CURRENT mA	
	STRAIGHT SHAFT	PINION SHAFT				SPEED rpm	INPUT W	CURRENT mA	TORQUE		TORQUE			CURRENT mA	TORQUE		
									kg-cm	N-m	kg-cm	N-m			kg-cm		N-m
⑪	8RN20S4L-B	8RN20GN4L-B	20	100	50	1250	50	500	1.50	0.147	1.04	0.102	900	8	0.10	0.010	100
						1550	50	500	1.17	0.115	1.04	0.102	850				
⑪	8RN20S4H-B	8RN20GN4H-B	20	220	50	1250	60	280	1.50	0.147	1.04	0.102	430	1.5	0.10	0.010	100
						1550	60	280	1.17	0.115	1.04	0.102	430				
⑫	8RN25S4L-B	8RN25GN4L-B	25	100	50	1300	65	650	1.80	0.176	1.28	0.125	1250	10	0.10	0.010	100
						1600	65	650	1.37	0.134	1.28	0.125	1200				
⑫	8RN25S4H-B	8RN25GN4H-B	25	220	50	1300	70	330	1.80	0.176	1.28	0.125	600	2	0.10	0.010	100
						1600	70	330	1.37	0.134	1.28	0.125	550				
⑬	9RN40S4L-B	9RN40P4L-B	40	100	50	1200	115	1150	3.20	0.314	2.60	0.255	1850	16	0.10	0.010	100
						1500	115	1150	2.60	0.255	2.60	0.255	1850				
⑬	9RN40S4H-B	9RN40P4H-B	40	220	50	1200	140	650	3.20	0.314	2.60	0.255	900	3.5	0.10	0.010	100
						1500	140	650	2.60	0.255	2.60	0.255	900				

GEAR HEAD

DECIMAL GEAR HEAD (RATIO 1/10)

GEAR HEAD (RATIO 1/3~1/180)

2 8DGN10Y WEIGHT 0.3kg

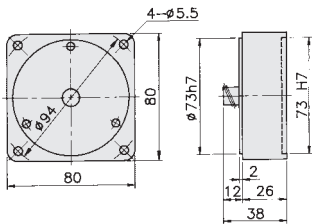

1 8GN□B
8GN□Y

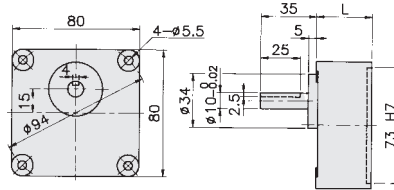

4 9DP10Y WEIGHT 0.6kg

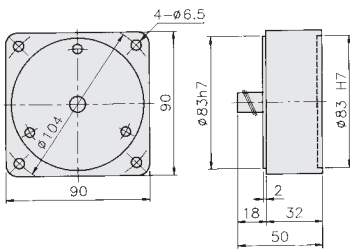

3 9P□B
9P□Y

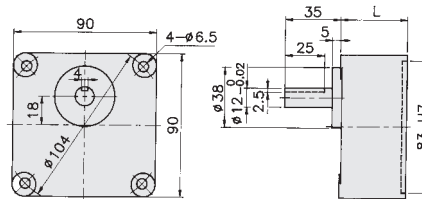

GEAR RATIO	L mm	WEIGHT(kg)	BOLT
1/3~1/18	42	0.8	M6×65
1/25~1/180	60	0.9	M6×80

KEY SIZE

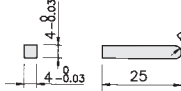

WIRING(SINGLE PHASE MOTOR)

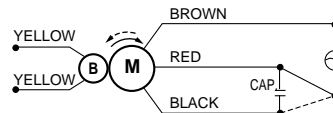

*Facing output shaft

- ⊕ THE NORMAL TORQUE(kg·cm) IS THAT THE MOTOR & GEAR HEAD ARE DIRECTLY COUPLED.
- ⊕ INSERT THE DENOMINATOR OF REDUCTION RATIO IN □ OF GEAR HEAD MODEL NAME.
- ⊕ ACTUAL ROTATION SPEED IS 2-15% LESS THAN SYNCHRONOUS SPEED.

DECIMAL GEAR HEAD	GEAR HEAD MODEL	SYNCHRONOUS SPEED (RPM)																
		DENOMINATOR OF REDUCTION RATIO	50Hz															
			3	5	7.5	12.5	15	25	30	50	75	100	150	250	300	500	750	1500
28DGN10Y	18GN□Y, 8GN□B	3.4	5.7	8.5	14	17	26	31	46	69	92	100	D35	D35	D65	D80	D100	
28DGN10Y	18GN□Y, 8GN□B	3.4	5.7	8.5	14	17	26	31	46	69	92	100	D35	D35	D65	D80	D100	
28DGN10Y	18GN□Y, 8GN□B	4.0	6.7	10	17	20	30	36	54	81	100	100	D35	D35	D65	D80	D100	
28DGN10Y	18GN□Y, 8GN□B	4.0	6.7	10	17	20	30	36	54	81	100	100	D35	D35	D65	D80	D100	
49DP10Y	99P□Y, 9P□B	7.6	13	19	32	38	57	68	102	120	120	120	D120	D120	D120	D120	D120	
49DP10Y	99P□Y, 9P□B	7.6	13	19	32	38	57	68	102	120	120	120	D120	D120	D120	D120	D120	

■ COLOR INDICATES THAT THE ROTATION OF GEARHEAD SHAFT IS IN OPPOSITE DIRECTION AS OUTPUT SHAFT OF MOTOR
D:USE DECIMAL GEAR

MAGNETIC BRAKE REVERSIBLE MOTOR

MOTOR

N - T CURVE

MOTOR DIMENSIONS

PINION SHAFT

62

⑭ 9RN60S4□-B 9RN60E4□-B

WEIGHT 2.8kg

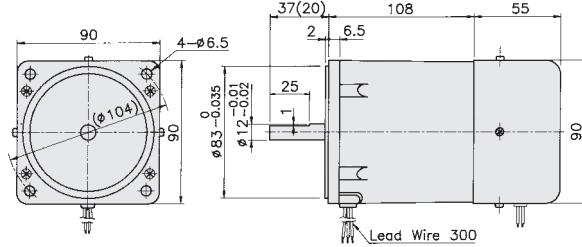
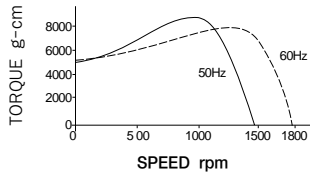

MODULE 0.8
PRESSURE ANGLE 20°
TEETH No. 11
DIAMETER ϕ 11.55mm
LENGTH 20mm

⑮ 9RF90S4□-B 9RF90E4□-B

WEIGHT 3.4kg

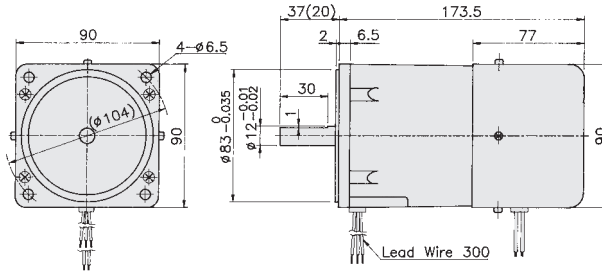
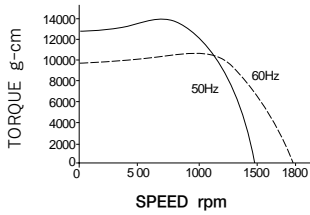

MODULE 0.8
PRESSURE ANGLE 20°
TEETH No. 11
DIAMETER ϕ 11.55mm
LENGTH 20mm

⑯ 9RF120S4□-B 9RF120E4□-B

WEIGHT 3.4kg

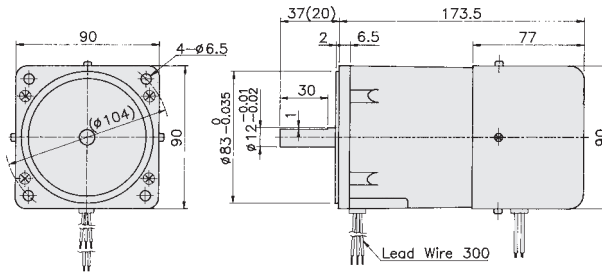
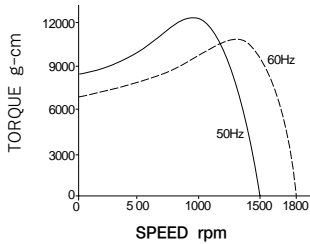

MODULE 0.8
PRESSURE ANGLE 20°
TEETH No. 11
DIAMETER ϕ 11.55mm
LENGTH 20mm

⊕ ELECTRICAL PERFORMANCES

- SINGLE PHASE, 4 POLES, 30MIN. DUTY, INSULATION CLASS "E"

FIG NO.	MODEL		OUTPUT W	VOLTAGE V	FREQUENCY Hz	RATED					STARTING		STARTING CURRENT mA	CAPACITOR μ F	BRAKE TORQUE		BRAKE CURRENT mA
	STRAIGHT SHAFT	PINION SHAFT				SPEED rpm	INPUT W	CURRENT mA	TORQUE		TORQUE kg-cm	TORQUE N-m					
									kg-cm	N-m							
⑭	9RN60S4L-B	9RN60E4L-B	60	100	50	1300	180	1800	4.50	0.441	3.50	0.343	3000	25	0.10	0.010	100
					60	1600	180	1800	3.80	0.372	3.50	0.343	3000				
⑭	9RN60S4H-B	9RN60E4H-B	60	220	50	1300	220	1000	4.50	0.441	3.50	0.343	1700	5	0.10	0.010	100
					60	1600	220	1000	3.80	0.372	3.50	0.343	1700				
⑮	9RF90S4L-B	9RF90E4L-B	90	100	50	1250	200	2000	6.80	0.666	4.20	0.412	3200	25	0.10	0.010	100
					60	1550	200	2000	5.70	0.559	4.20	0.412	3000				
⑮	9RF90S4H-B	9RF90E4H-B	90	220	50	1250	200	1000	6.80	0.666	4.20	0.412	1600	5	0.10	0.010	100
					60	1550	200	1000	5.70	0.559	4.20	0.412	1500				
⑯	9RF120S4L-B	9RF120E4L-B	120	100	50	1300	240	2400	8.70	0.853	6.00	0.588	4800	35	0.10	0.010	100
					60	1600	240	2400	7.30	0.715	6.00	0.588	4600				
⑯	9RF120S4H-B	9RF120E4H-B	120	220	50	1300	320	1400	8.70	0.853	6.00	0.588	3200	7	0.10	0.010	100
					60	1600	320	1400	7.30	0.715	6.00	0.588	3200				

GEAR HEAD

DECIMAL GEAR HEAD (RATIO 1/10)

GEAR HEAD (RATIO 1/3~1/180)

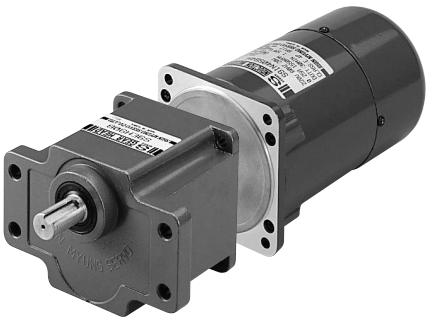

5 9E□B

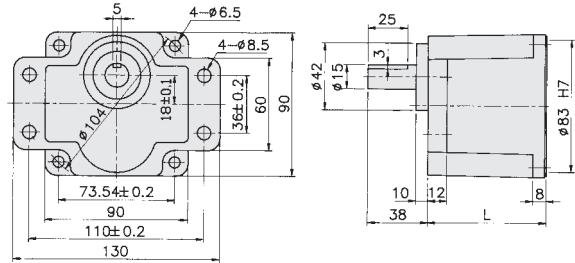

GEAR RATIO	mm L	WEIGHT(kg)	BOLT
1/3~1/60	65	1.6	M6×25
1/75~1/18	85	2.0	M6×25

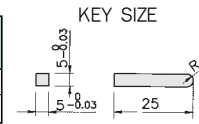

KEY SIZE

WIRING(SINGLE PHASE MOTOR)

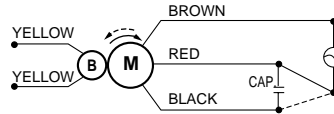

* Facing output shaft

- ⊕ THE NORMAL TORQUE(kg-cm) IS THAT THE MOTOR & GEAR HEAD ARE DIRECTLY COUPLED.
- ⊕ INSERT THE DENOMINATOR OF REDUTION RATIO IN □ OF GEAR HEAD MODEL NAME.
- ⊕ ACTUAL ROTATION SPEED IS 2-15% LESS THAN SYNCHRONOUS SPEED.

DECIMAL GEAR HEAD	GEAR HEAD MODEL	SYNCHRONOUS SPEED (RPM)		500	300	200	120	100	60	50	30	20	15	10	6	5	3	2	1
		DENOMINATOR OF REDUCTION RATIO	50Hz	3	5	7.5	12.5	15	25	30	50	75	100	150	250	300	500	750	1500
			60Hz	3.6	6	9	15	18	30	36	60	90	120	180	300	360	600	900	1800
—	5 9E□B		11	18	28	42	50	75	90	150	202	269	300	-	-	-	-	-	
—	5 9E□B		11	18	28	42	50	75	90	150	202	269	300	-	-	-	-	-	
—	5 9E□B		17	28	42	62	75	112	135	224	300	300	300	-	-	-	-	-	
—	5 9E□B		17	28	42	62	75	112	135	224	300	300	300	-	-	-	-	-	
—	5 9E□B		21	35	53	80	96	144	172	287	300	300	300	-	-	-	-	-	
—	5 9E□B		21	35	53	80	96	144	172	287	300	300	300	-	-	-	-	-	

■ COLOR INDICATES THAT THE ROTATION OF GEARHEAD SHAFT IS IN OPPOSITE DIRECTION AS OUTPUT SHAFT OF MOTOR
D:USE DECIMAL GEAR

DC MOTOR

DIMENSIONS

□ 60mm

PINION SHAFT

64

1 10W

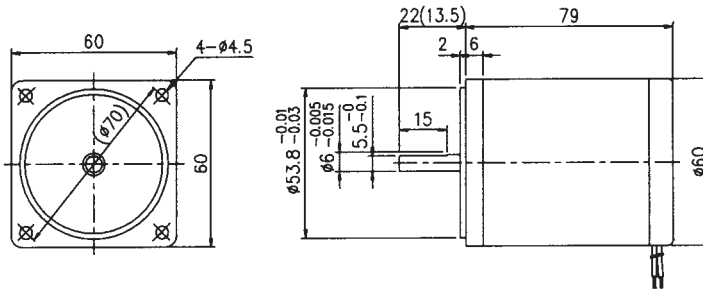

MODULE	0.5
PRESSURE ANGLE	20°
TEETH No.	8
DIAMETTER	$\phi 5.98\text{mm}$
LENGTH	13.5mm

2 20W

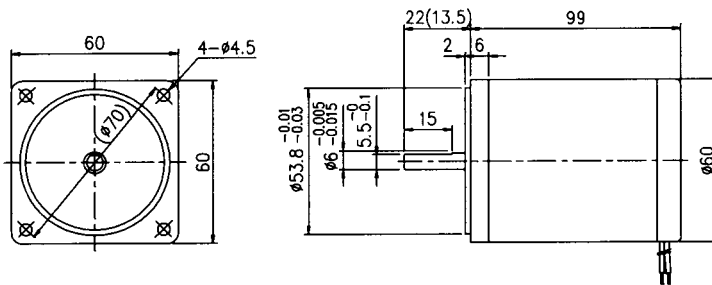

MODULE	0.5
PRESSURE ANGLE	20°
TEETH No.	8
DIAMETTER	$\phi 5.98\text{mm}$
LENGTH	13.5mm

3 30W

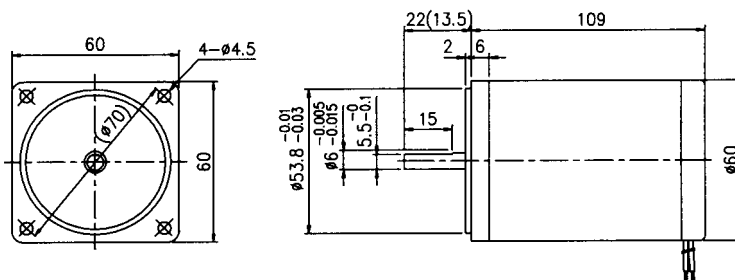

MODULE	0.5
PRESSURE ANGLE	20°
TEETH No.	8
DIAMETTER	$\phi 5.98\text{mm}$
LENGTH	13.5mm

FIG. NO.	MODEL		OUTPUT W	SPEED rpm	VOLTAGE V	TORQUE kg-cm(N-m)	RATED CURRENT A
	STRAIGHT SHAFT	PINION SHAFT					
1	6DN10S2□	6DN10G2□	10	3000	24	0.32	0.60
					90		0.20
					180		0.12
2	6DN20S2□	6DN20G2□	20	3000	24	0.65	1.20
					90		0.30
					180		0.15
3	6DN30S2□	6DN30G2□	30	3000	24	0.97	1.80
					90		0.50
					180		0.22

GEAR HEAD

DIMENSIONS



GEARHEAD 6G□Y(B)

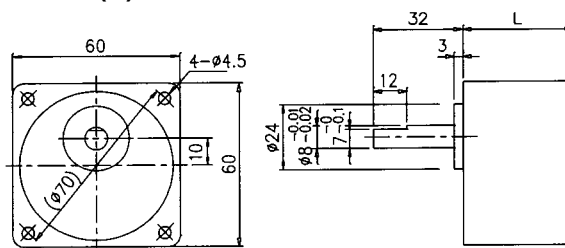

GEAR RATIO	L mm	WEIGHT(kg)	BOLT
1/3~1/18	30	0.25	M4×50
1/25~1/180	40	0.35	M4×60

DECIMAL GEARHEAD 6DG10Y(B)

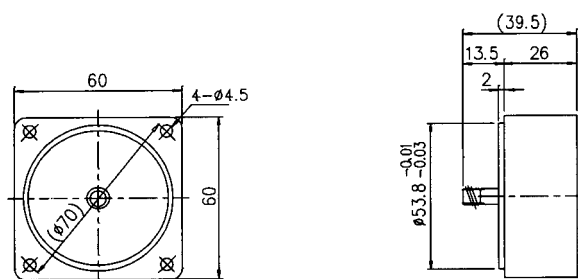

- ⊕ □ OF GEAR HEAD MODEL NAME INDICATE THE DEDUCTION RATIO.
- ⊕ THE NORMAL TORQUE(kg·cm) IS THAT THE MOTOR & GEAR HEAD ARE DIRECTLY COUPLED.
THE NORMAL TORQUE(kg·cm) IS 30kg·cm IN CASE THE DECIMAL GEARHEAD OF THE DEDUCTION RATIO 1/10 IS CONNECTED.
- ⊕ THE ROTATION DIRECTION OF OUTPUT SHAFT FOR THE GEARHEAD INDICATED ■ ROTATES WITH MOTOR ON THE CONTRARY.
- ⊕ THE ACTUAL ROTATION SPEED IS 2-20% LESS THAN SYNCHRONOUS SPEED ACCORDING TO THE SIZE OF THE LOAD.

MODEL	rpm	1000	833	600	500	400	333	240	200	166	150	120	100	83	60	50	40	33	30	25	20	16
	RATIO	3	3.6	5	6	7.5	9	12.5	15	18	20	25	30	36	50	60	75	90	100	120	150	180
6G□Y	kg·cm	0.8	1.0	1.4	1.7	2.2	2.6	3.6	4.3	5.2	5.4	6.8	8.2	9.8	13.6	15.3	19	23	25	30	30	30
	kg·cm	1.7	2.1	2.9	3.5	4.4	5.2	7.3	8.7	10.5	11.0	13.8	16.5	19.8	27	30	30	30	30	30	30	30
6G□B	kg·cm	2.4	2.9	4.0	4.8	6.0	7.2	10.1	12.1	14.5	15.3	19.0	22	27	30	30	30	30	30	30	30	30

DC MOTOR

MOTOR

PINION SHAFT

66

① 8DN25S2□
8DN25GN2□

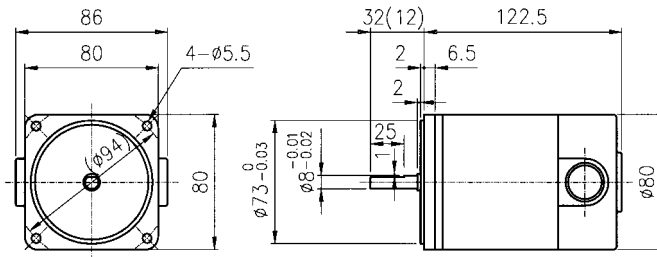

MODULE 0.5
PRESSURE ANGLE 20°
TEETH No. 10
DIAMETTER ϕ 7.2mm
LENGTH 12mm

② 9DN40S2□
9DN40P2□

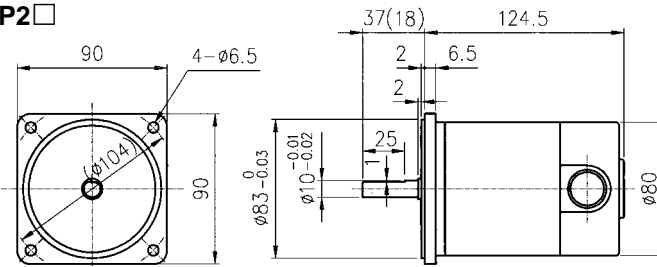

MODULE 0.6
PRESSURE ANGLE 20°
TEETH No. 12
DIAMETTER ϕ 9.63mm
LENGTH 18mm

③ 9DN60S2□ 9DN90S2F
9DN60E2□ 9DN90E2F

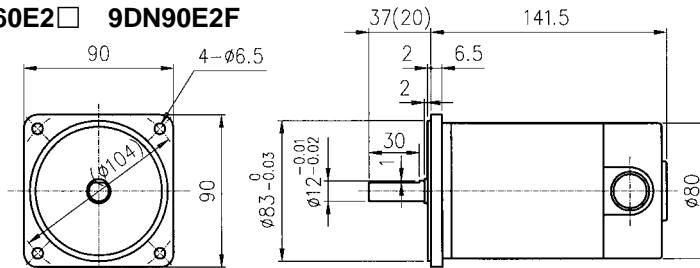

MODULE 0.8
PRESSURE ANGLE 20°
TEETH No. 11
DIAMETTER ϕ 11.55mm
LENGTH 20mm

④ 9DN90S2A 9DN90S2R
9DN90E2A 9DN90E2R

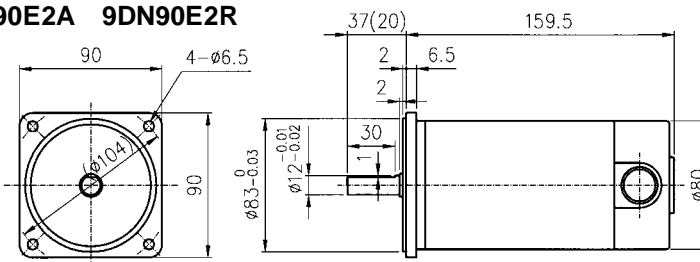

MODULE 0.8
PRESSURE ANGLE 20°
TEETH No. 11
DIAMETTER ϕ 11.55mm
LENGTH 20mm

FIG. NO.	MODEL		OUTPUT W	SPEED rpm	VOLTAGE V	TORQUE kg-cm(N-m)	RATED CURRENT A	PEAK CURRENT A	DECIMAL GEAR HEAD	GEAR HEAD
	STRAIGHT SHAFT	PINION SHAFT								
①	8DN25S2R	8DN25GN2R	25	3000	24	0.78 (0.078)	1.3	10.0	②8DGN10Y	①8GN□Y, 8GN□B
	8DN25S2A	8DN25GN2A			90		0.4	3.0		
	8DN25S2F	8DN25GN2F			180		0.25	1.5		
②	9DN40S2R	9DN40P2R	40	3000	24	1.300 (0.127)	2.0	17	④9DP10Y	③9P□Y, 9P□B
	9DN40S2A	9DN40P2A			90		0.8	4.5		
	9DN40S2F	9DN40P2F			180		0.4	1.35		
③	9DN60S2R	9DN60E2R	60	3000	24	1.95 (0.191)	3.2	25.0	N/A	⑤9E□B
	9DN60S2A	9DN60E2A			90		0.95	6.5		
	9DN60S2F	9DN60E2F			180		0.50	3.25		
④	9DN90S2R	9DN90E2R	90	3000	24	2.92 (0.286)	5.0	37.5	N/A	⑤9E□B
	9DN90S2A	9DN90E2A			90		1.3	10.0		
	9DN90S2F	9DN90E2F			180		0.7	5.0		

GEAR HEAD

DECIMAL GEAR HEAD

2 8DGN10Y

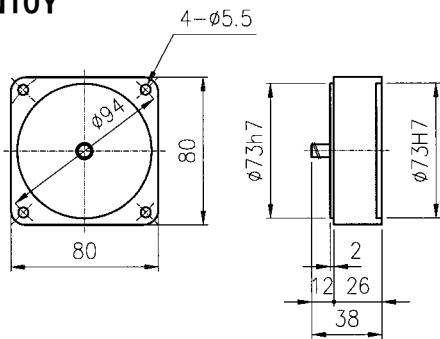

4 9DP10Y

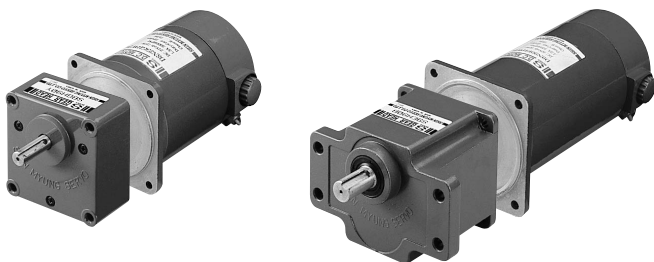
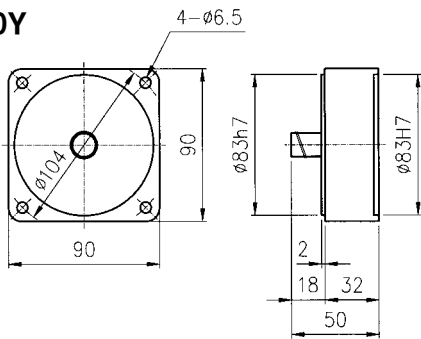

1 8GN□B 8GN□Y

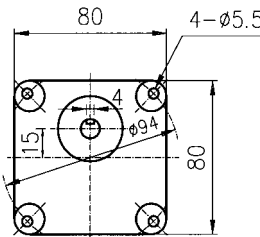

GEAR RATIO	L (mm)	WEIGHT(kg)	BOLT
1/3~1/18	30	0.5	M5×50
1/25~1/180	40	0.6	M5×60

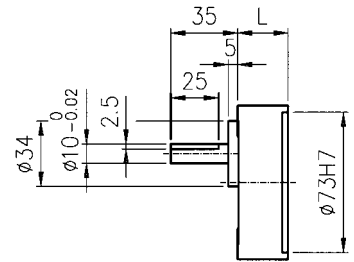

KEY SIZE

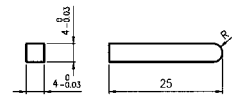

3 9P□B 9P□Y

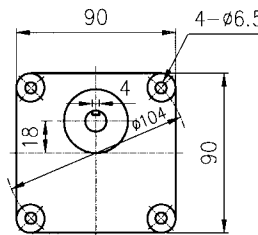

GEAR RATIO	L (mm)	WEIGHT(kg)	BOLT
1/3~1/18	42	0.8	M6×65
1/25~1/180	60	0.9	M6×80

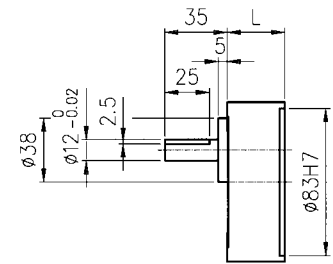

KEY SIZE

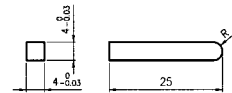

5 9E□B

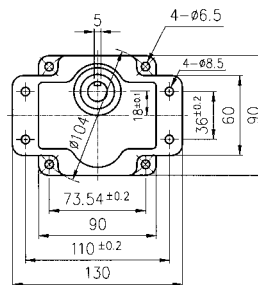

GEAR RATIO	L (mm)	WEIGHT(kg)	BOLT
1/3~1/60	65	1.6	M6×25
1/75~1/180	85	2.0	M6×25

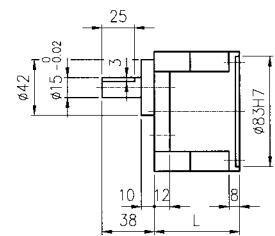

KEY SIZE

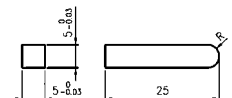

⊕ THE NORMAL TORQUE(kg.cm) IS THAT THE MOTOR & GEAR HEAD ARE DIRECTLY COUPLED.

⊕ INSERT THE DENOMINATOR OF REDUTION RATIO IN □ OF GEAR HEAD MODEL NAME.

⊕ ACTUAL ROTATION SPEED IS 2-15% LESS THAN SYNCHRONOUS SPEED.

	SPEED	1000	833	600	500	400	333	240	200	166	120	100	83	60	50	40	33	30	25	20	16	12	10	8.3	6	5	4	3.3	2	1.6
	RATIO	3	3.6	5	6	7.5	9	12.5	15	18	25	30	36	50	60	75	90	100	120	150	180	250	300	360	500	600	750	900	1500	1800
		2.0	2.4	3.3	4.0	5.0	6.0	8.3	10	12	15	18	22	27	32	40	48	54	65	81	97	D	D	D	D	D	D	D	D	D
		3.2	3.8	5.2	6.3	7.9	9.5	13	16	19	24	28	34	43	51	64	77	85	102	120	120	D	D	D	D	D	D	D	D	D
		4.7	5.7	7.9	9.5	12	14	20	21	26	32	38	46	64	77	86	104	115	138	173	207									
		7.1	8.5	12	14	18	21	30	32	38	48	57	69	96	115	129	155	172	207	259	300									

■ COLOR INDICATES THAT THE ROTATION OF GEARHEAD SHAFT IS IN OPPOSITE DIRECTION AS OUTPUT SHAFT OF MOTOR
D:USE DECIMAL GEAR

DC MOTOR CONTROLLER

68

- * Model : T-2110P
-Applying for DC Motor 25~90W

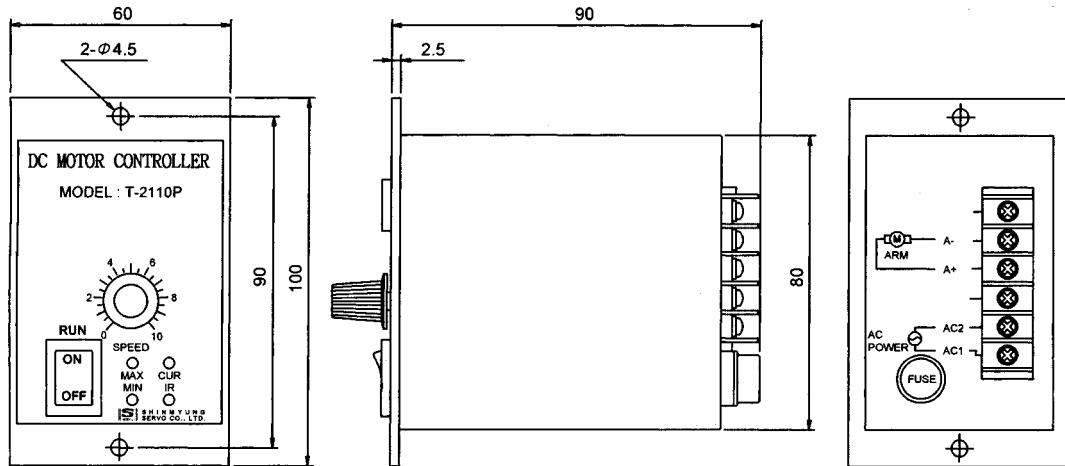

WIRING

AC : to be connected AC 110V or 220V power
(Input 110VAC-Output 90VDC,
Input 220VAC-Output 180VDC)

A+ : to be Connected to Plus(+) armature
wire(red wire) on the motor.

A- : to be Connected Minus(-) Armature wire on the motor



INSTALLATION

- Ambient temperature and humidity : -10°C~40°C, below 75%(protect from the direct rays of the sun)
- Keep away from a place of vibration, a shock, dusty, inflammable, and corrosive.
- Work carefully for the wiring. The wires between Controller and DC Motor are to be closed to each other.
- Use(install) a Noise Filter when the Motor accures a noise.

WORM GEARHEAD DIMENSIONS

■ Hollow type output shaft

9W□B-H

GEAR RATIO	WEIGHT(kg)	BOLT
1/10~1/60	1.2	M6×20

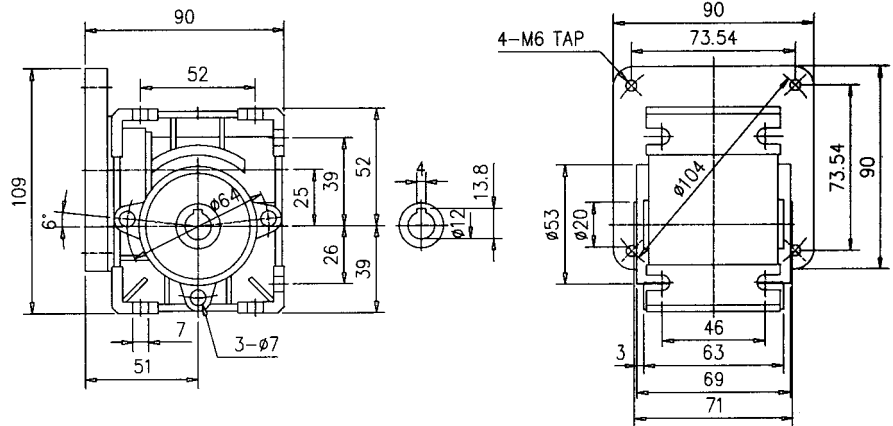

■ Dual oriented output shaft

9W□B-D

GEAR RATIO	WEIGHT(kg)	BOLT
1/10~1/60	1.2	M6×20

Key size : 5x5x25

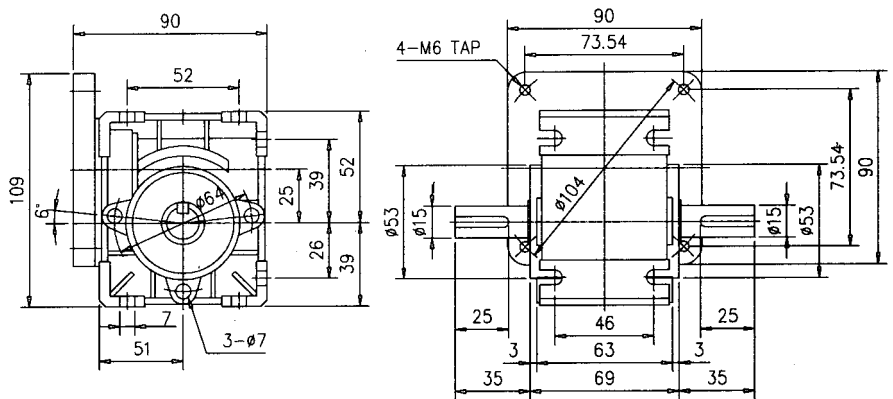

■ Right or Left oriented output shaft

9W□B-R,L

GEAR RATIO	WEIGHT(kg)	BOLT
1/10~1/60	1.2	M6×20

Key size : 5x5x25

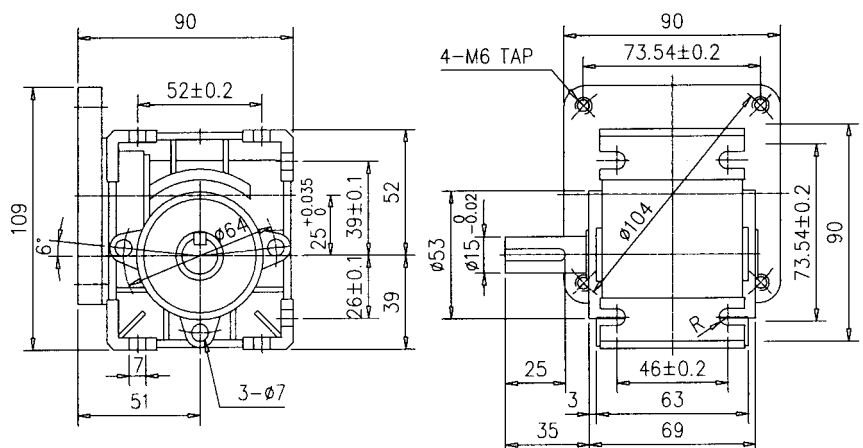

NEW PRODUCT *WORM GEARHEAD TYPE*

APPLICATION : 40W. 60W.



■ TABLE FOR THE TARQUE(kg·cm) OF WORM GEARHEAD CONNECTED WITH MOTER:

MODEL NAME	OUTPUT W	DUTY	RATIO		1:10	1:20	1:30	1:40	1:50	1:60
			SPEED (rpm)	60Hz	180	90	60	45	36	30
				50Hz	150	75	50	37	30	25
* INDUCTION MOTOR										
9IN40W4H	40	CONTINUOUS	50Hz	20	33	41	49	54	60	
			60Hz	17	28	34	41	45	51	
9IF60W4H	60	CONTINUOUS	50Hz	30	50	60	60	60	60	
			60Hz	25	42	52	60	60	60	
* REVERSIBLE MOTOR										
9RN40W4H	40	30 MIN	50Hz	21	35	44	52	57	60	
			60Hz	17	29	35	42	46	53	
9RN60W4H	60	30 MIN	50Hz	30	50	60	60	60	60	
			60Hz	25	42	52	60	60	60	
* SPEED CONTROL MOTOR										
9IN40W4H-V	40		50Hz / 60Hz	4~19	7~31	8~38	10~45	11~50	12~57	
9IN40W4H-V	60		50Hz / 60Hz	8~25	13~41	16~51	19~60	21~60	24~60	
* MAGNETIC BROKE MOTOR										
9IN40W4H-B	40	CONTINUOUS	50Hz	20	33	41	49	54	60	
			60Hz	17	28	34	41	45	51	
9IF60W4H-B	60	CONTINUOUS	50Hz	30	50	60	60	60	60	
			60Hz	25	42	52	60	60	60	

* ACTUAL ROTATION SPEED IS 2-15% LESS THAN SYNCHRONOUS SPEED.

