

**COMPACT
PNEUMATIC CYLINDER
PK-A SERIES Ø32- Ø100**





PK-A SERIES

COMPACT - Ø32 - Ø100

COMPACT MAGNETIC CYLINDER

NEED HIGHER POWER IN A TIGHTER SPACE? PK-A IS THE PERFECT CHOICE



PK: COMPACT CYLINDERS WITH DOUBLE ACTING



PK-A: MAGNETIC COMPACT CYLINDERS WITH DOUBLE ACTING

Example of order:

PK-A
Product Code

032-025
Cylinder Ø
Stroke

K1 M1
Variants from
Standard System

VARIANTS FROM STANDARD SYSTEM:

- R1: Stainless Steel Piston Rod (SS 304-SS 316)
- R4: Stainless Steel Nut for Piston Rod (SS 304)
- R5: Piston Rod as CK45 (Hard Chrome Plated)
- M1: Extended male Piston Rod Thread
- M3: Special Piston Rod Thread
- M4: Extended Piston Rod
- K1: Seals for Max. 150°C (Viton)
- K4: Piston Rod Seal Viton

Force:

Cylinder Ø mm	Rod Ø mm	Thrust and traction forces (6 Bar)	
		Thrust Force (N)	Traction Force (N)
32	12	482	415
40	12	754	687
50	16	1178	1058
63	16	1869	1750
80	20	3014	2829
100	25	4710	4420

Working Fluid:

Filtered and lubricated or filtered and not lubricated air

Operating Temperature Range:

Polyurethane (PU) : (-20°C) - (+80°C)
 Viton (FKM) : (-30°C) - (+180°C)

Max. Work Pressure:

10 Bar

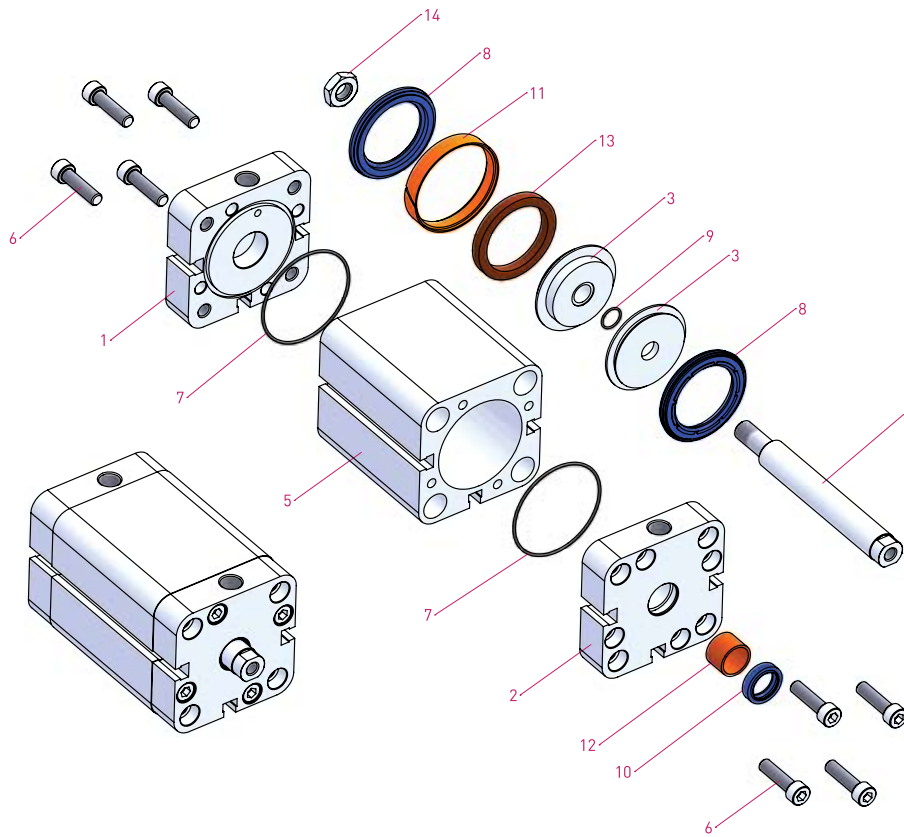
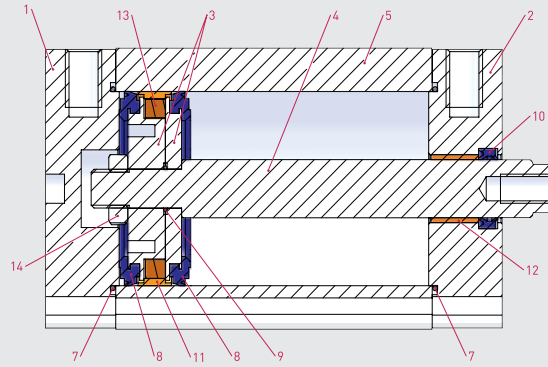

No	MATERIAL NAME	CHARACTERISTIC	PC.
1	Rear Head	Aluminium	1
2	Front Head	Aluminium	1
3	Middle Piston	Aluminium	2
4	Piston Rod	X20 Cr13 Hard Chrome Plated	1
5	Tube	Al Mg Si 0,5 + Eloxal Plated	1
6	Bolt	Stainless Steel	8
7	Head O-ring	NBR	2

No	MATERIAL NAME	CHARACTERISTIC	PC.
8	Piston Seal	PU	2
9	Middle Piston O-ring	NBR	1
10	Rod Seal	PU	1
11	Guiding Band	Polyacetal	1
12	Guiding Bush	CSB-40	1
13	Magnet		1
14	Nut	Galvanized Steel	1



PK-A SERIES
COMPACT - Ø32 - Ø100

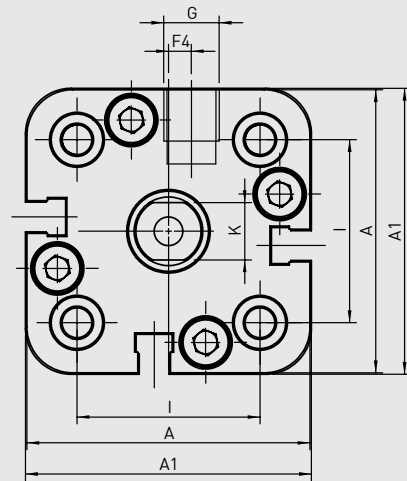
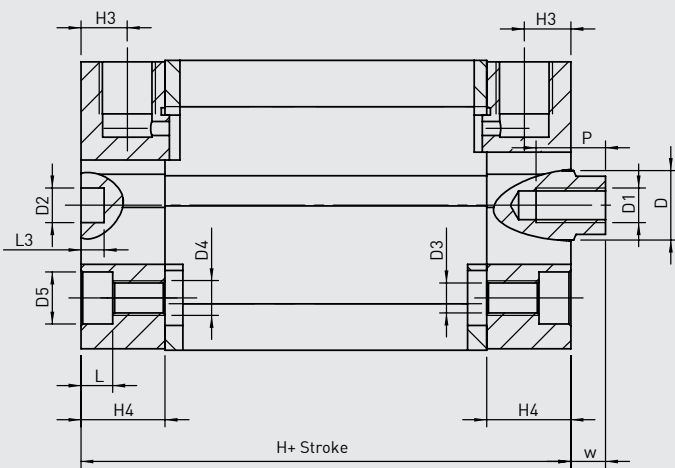

Cylinder Ø mm	A	A1	D Ø	D1 Ø	D2 Ø	D3 Ø	D4 Ø	D5 Ø	F4	G	H	H3	H4	I	K	L	L3	P	W
32	49,5	50	12	M6	6	5,2	M6	9	4	1/8"	44,5	8	14,5	32	10	5,5	4	12	6
40	57,5	58	12	M6	6	5,2	M6	9	3	1/8"	45,5	8	14,75	42	10	5,5	4	12	6,5
50	66,5	67	16	M8	6	6,7	M8	10,5	0	1/8"	45,5	8	14,75	50	13	6,5	4	12	7,5
63	79,5	80	16	M8	8	8,7	M10	13,5	0	1/8"	50	8	14,75	62	13	8,5	4	14	7,5
80	99,5	100	20	M10	8	8,7	M10	13,5	0	1/8"	56	8,5	16,5	82	17	8,5	4	15	8
100	123,5	124	25	M12	8	8,7	M10	13,5	0	1/4"	66,5	10,5	19,75	103	22	8,5	4	20	10



PK-T

PKS-T

PKE-T

PKD-T

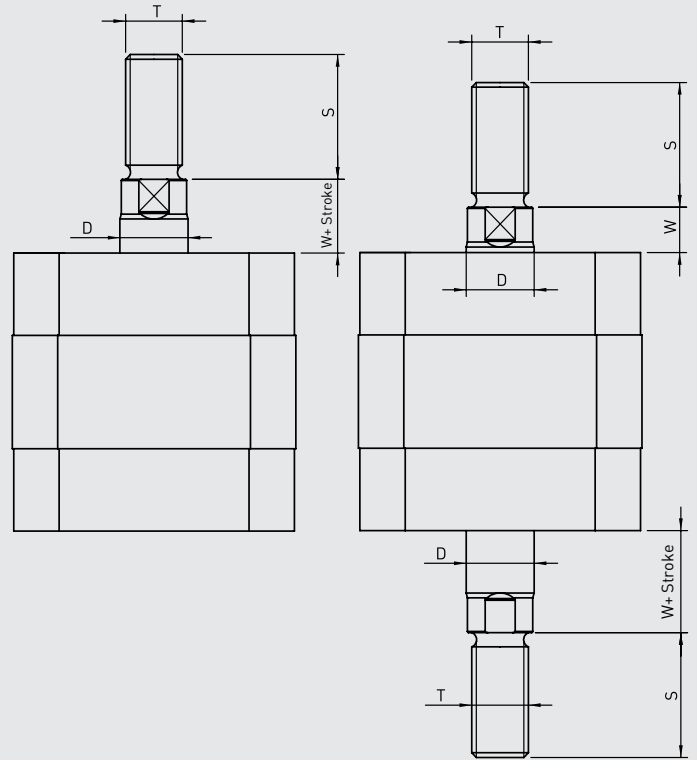
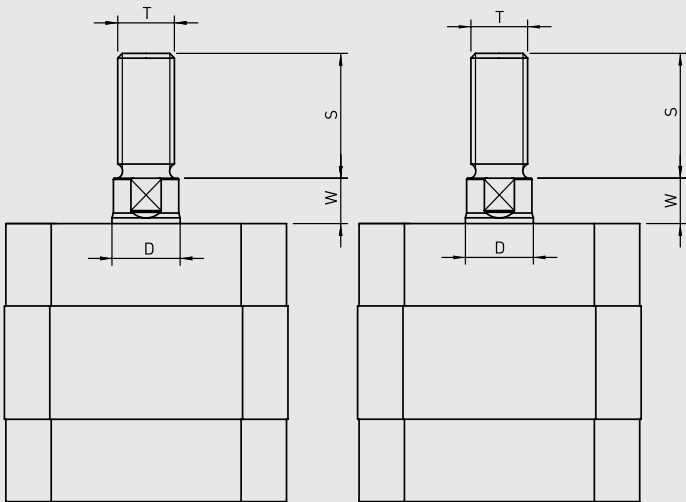

Cylinder type	Cylinder Ø mm	D	S	T	W
	32	12	22	M10x1.25	6
	40	12	22	M10x1.25	6.5
PK-PKS	50	16	24	M12x1.25	7.5
PKE-PKD	63	16	24	M12x1.25	7.5
	80	20	32	M16x1.5	8
	100	25	40	M20x1.5	10