

## Features

- 1 & 2 Pole relay interface modules**
- 5 µm Gold plate contacts for low level switching capability**
- 49.31-50x0 - 1 Pole 10 A (screw terminal)**  
**49.52-50x0 - 2 Pole 8 A (screw terminal)**  
**49.72-50x0 - 2 Pole 8 A (screwless terminal)**
- 15.5 mm wide
  - Ideal interface for PLC and electronic systems
  - AC coils & DC coils
  - Instant ejection of relay using plastic retaining clip
  - Supply status indication and coil suppression module
  - Identification labels
  - 35 mm rail (EN 50022) mounting

49.31-50x0 / 49.52  
Screw terminal

49.72-50x0  
Screwless terminal



For outline drawing see page 8

### 49.31-50x0



- 1 pole, 10 A
- AgNi + Au (5 µm) contact material
- Screw terminal
- 35 mm rail (EN 50022) mounting

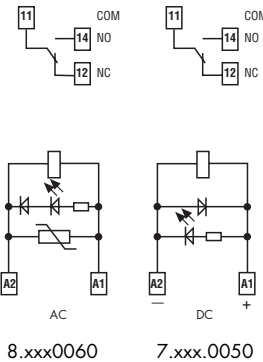

### 49.52/72-50x0



- 2 pole, 8 A
- AgNi + Au (5 µm) contact material
- Screw terminal and screwless terminal
- 35 mm rail (EN 50022) mounting

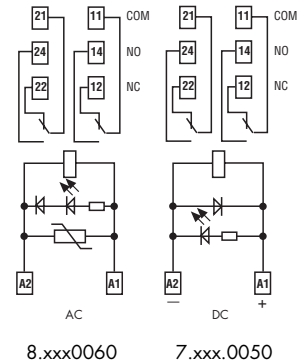

\*\* By external parallel connection of the contacts the values within [1 (0.1/1)] can be achieved.

Contact specification		49.31-50x0	49.52/72-50x0
Contact configuration		1 CO (SPDT)	2 CO (DPDT)
Rated current/Maximum peak current	A	10/20	8/15
Rated voltage/Maximum switching voltage V AC		250/400	250/250
Rated load AC1	VA	2,500	2,000
Rated load AC15 (230 V AC)	VA	500	400
Single phase motor rating (230 V AC)	kW	0.37	0.3
Breaking capacity DC1: 30/110/220V	A	10/0.3/0.12	8/0.3/0.12
Minimum switching load	mW (V/mA)	50 (5/2)	50 (5/2) - [1 (0.1/1)]*
Standard contact material		AgNi + Au (5 µm)	AgNi + Au (5 µm)
Coil specification			
Nominal voltage (U <sub>N</sub> )	V AC (50/60 Hz)	12 - 24 - 110 - 120 - 230	12 - 24 - 110 - 120 - 230
	V DC	12 - 24 - 125	12 - 24 - 125
Rated power AC/DC/sens.DC	VA (50 Hz)/W/W	1.2/0.65/0.5	1.2/0.65/0.5
Operating range	AC	(0.8...1.1)U <sub>N</sub>	(0.8...1.1)U <sub>N</sub>
	DC/sensitiv DC	(0.73...1.5)U <sub>N</sub> /(0.73...1.7)U <sub>N</sub>	(0.73...1.5)U <sub>N</sub> /(0.73...1.7)U <sub>N</sub>
Holding voltage	AC/DC	0.8 U <sub>N</sub> / 0.4 U <sub>N</sub>	0.8 U <sub>N</sub> / 0.4 U <sub>N</sub>
Must drop-out voltage	AC/DC	0.2 U <sub>N</sub> / 0.1 U <sub>N</sub>	0.2 U <sub>N</sub> / 0.1 U <sub>N</sub>
Technical data			
Mechanical life AC/DC	cycles	10 · 10 <sup>6</sup> /20 · 10 <sup>6</sup>	10 · 10 <sup>6</sup> /20 · 10 <sup>6</sup>
Electrical life at rated load AC1	cycles	150 · 10 <sup>3</sup>	150 · 10 <sup>3</sup>
Operate/release time	ms	7/4 (AC) - 12/12 (DC)	7/4 (AC) - 12/12 (DC)
Insulation between coil and contacts (1.2/50 µs)	kV	6 (8 mm)	6 (8 mm)
Dielectric strength between open contacts V AC		1,000	1,000
Ambient temperature range	°C	-40...+70	-40...+70
Protection category		IP 20	IP 20

Approvals relay (according to type)



## Features

1 & 2 Pole relay interface modules

AgNi contacts for medium duty switching

49.31-00x0 - 1 Pole 10 A (screw terminal)

49.52-00x0 - 2 Pole 8 A (screw terminal)

49.72-00x0 - 2 Pole 8 A (screwless terminal)

- 15.5 mm wide
- Ideal interface for PLC and electronic systems
- AC coils & DC coils
- Instant ejection of relay using plastic retaining clip
- Supply status indication and coil suppression module
- Identification labels
- 35 mm rail (EN 50022) mounting

49.31-00x0 / 49.52  
Screw terminal

49.72-00x0  
Screwless terminal



### 49.31-00x0



- 1 pole, 10 A
- AgNi contact material
- Screw terminal
- 35 mm rail (EN 50022) mounting

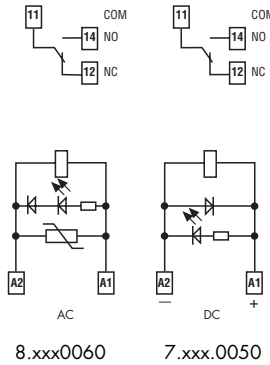

### 49.52/72-00x0



- 2 pole, 8 A
- AgNi contact material
- Screw terminal and screwless terminal
- 35 mm rail (EN 50022) mounting

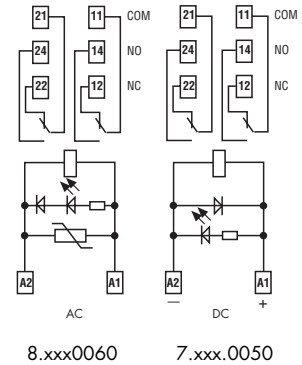

For outline drawing see page 8

Contact specification		1 CO (SPDT)	2 CO (DPDT)
Contact configuration		1 CO (SPDT)	2 CO (DPDT)
Rated current/Maximum peak current	A	10/20	8/15
Rated voltage/Maximum switching voltage	V AC	250/400	250/250
Rated load AC1	VA	2,500	2,000
Rated load AC15 (230 V AC)	VA	500	400
Single phase motor rating (230 V AC)	kW	0.37	0.3
Breaking capacity DC1: 30/110/220V	A	10/0.3/0.12	8/0.3/0.12
Minimum switching load	mW (V/mA)	300 (5/5)	300 (5/5)
Standard contact material		AgNi	AgNi
Coil specification			
Nominal voltage (U <sub>N</sub> )	V AC (50/60 Hz)	12 - 24 - 110 - 120 - 230	12 - 24 - 110 - 120 - 230
	V DC	12 - 24 - 125	12 - 24 - 125
Rated power AC/DC/sens.DC	VA (50 Hz)/W/W	1.2/0.65/0.5	1.2/0.65/0.5
Operating range	AC	(0.8...1.1)U <sub>N</sub>	(0.8...1.1)U <sub>N</sub>
	DC/sensitiv DC	(0.73...1.5)U <sub>N</sub> / (0.73...1.7)U <sub>N</sub>	(0.73...1.5)U <sub>N</sub> / (0.73...1.7)U <sub>N</sub>
Holding voltage	AC/DC	0.8 U <sub>N</sub> / 0.4 U <sub>N</sub>	0.8 U <sub>N</sub> / 0.4 U <sub>N</sub>
Must drop-out voltage	AC/DC	0.2 U <sub>N</sub> / 0.1 U <sub>N</sub>	0.2 U <sub>N</sub> / 0.1 U <sub>N</sub>
Technical data			
Mechanical life AC/DC	cycles	10 · 10 <sup>6</sup> / 20 · 10 <sup>6</sup>	10 · 10 <sup>6</sup> / 20 · 10 <sup>6</sup>
Electrical life at rated load AC1	cycles	200 · 10 <sup>3</sup>	150 · 10 <sup>3</sup>
Operate/release time	ms	7/4 (AC) - 12/12 (DC)	7/4 (AC) - 12/12 (DC)
Insulation between coil and contacts (1.2/50 μs)	kV	6 (8 mm)	6 (8 mm)
Dielectric strength between open contacts	V AC	1,000	1,000
Ambient temperature range	°C	-40...+70	-40...+70
Protection category		IP 20	IP 20

Approvals relay (according to type)



## Features

- 1 & 2 Pole relay interface modules**
- AgCdO contacts for heavy duty switching**
- 49.31-20x0 - 1 Pole 10 A (screw terminal)**
  - 49.52-20x0 - 2 Pole 8 A (screw terminal)**
  - 49.72-20x0 - 2 Pole 8 A (screwless terminal)**
- 15.5 mm wide
  - Ideal interface for PLC and electronic systems
  - AC coils & DC coils
  - Instant ejection of relay using plastic retaining clip
  - Supply status indication and coil suppression module
  - Identification labels
  - 35 mm rail (EN 50022) mounting

49.31-20x0 / 49.52  
Screw terminal

49.72-20x0  
Screwless terminal



For outline drawing see page 8

Contact specification		49.31-20x0	49.52/72-20x0
Contact configuration		1 CO (SPDT)	2 CO (DPDT)
Rated current/Maximum peak current	A	10/20	8/15
Rated voltage/Maximum switching voltage	V AC	250/400	250/250
Rated load AC1	VA	2,500	2,000
Rated load AC15 (230 V AC)	VA	500	400
Single phase motor rating (230 V AC)	kW	0.37	0.3
Breaking capacity DC1: 30/110/220V	A	10/0.3/0.12	8/0.3/0.12
Minimum switching load	mW (V/mA)	500 (10/5)	500 (10/5)
Standard contact material		AgCdO	AgCdO
Coil specification			
Nominal voltage (U <sub>N</sub> )	V AC (50/60 Hz)	12 - 24 - 110 - 120 - 230	12 - 24 - 110 - 120 - 230
	V DC	12 - 24 - 125	12 - 24 - 125
Rated power AC/DC/sens.DC	VA (50 Hz)/W/W	1.2/0.65/0.5	1.2/0.65/0.5
Operating range	AC	(0.8...1.1)U <sub>N</sub>	(0.8...1.1)U <sub>N</sub>
	DC/sensitiv DC	(0.73...1.5)U <sub>N</sub> /(0.73...1.75)U <sub>N</sub>	(0.73...1.5)U <sub>N</sub> /(0.73...1.75)U <sub>N</sub>
Holding voltage	AC/DC	0.8 U <sub>N</sub> / 0.4 U <sub>N</sub>	0.8 U <sub>N</sub> / 0.4 U <sub>N</sub>
Must drop-out voltage	AC/DC	0.2 U <sub>N</sub> / 0.1 U <sub>N</sub>	0.2 U <sub>N</sub> / 0.1 U <sub>N</sub>
Technical data			
Mechanical life AC/DC	cycles	10 · 10 <sup>6</sup> / 20 · 10 <sup>6</sup>	10 · 10 <sup>6</sup> / 20 · 10 <sup>6</sup>
Electrical life at rated load AC1	cycles	200 · 10 <sup>3</sup>	150 · 10 <sup>3</sup>
Operate/release time	ms	7/4 (AC) - 12/12 (DC)	7/4 (AC) - 12/12 (DC)
Insulation between coil and contacts (1.2/50 μs)	kV	6 (8 mm)	6 (8 mm)
Dielectric strength between open contacts	V AC	1,000	1,000
Ambient temperature range	°C	-40...+70	-40...+70
Protection category		IP 20	IP 20
Approvals relay (according to type)			

### 49.31-20x0



- 1 pole, 10 A
- AgCdO contact material
- Screw terminal
- 35 mm rail (EN 50022) mounting

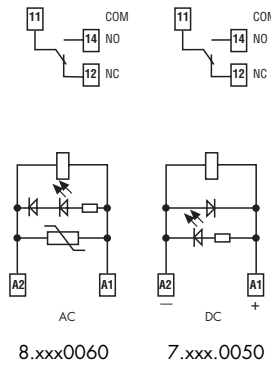

### 49.52/72-20x0



- 2 pole, 8 A
- AgCdO contact material
- Screw terminal and screwless terminal
- 35 mm rail (EN 50022) mounting

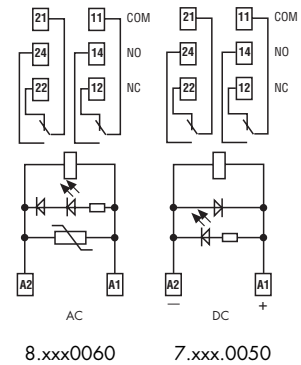

## Features

### 1 Pole relay interface module

#### AgCdO contacts for heavy duty switching

- 49.61-20x0 - 1 Pole 16 A (screw terminal)
- 49.81-20x0 - 1 Pole 16 A (screwless terminal)

#### AgSnO<sub>2</sub> contacts for heavy duty, high current inrush switching

- 49.61-40x0 - 1 Pole 16 A (screw terminal)
- 49.81-40x0 - 1 Pole 16 A (screwless terminal)

- 15.5 mm wide
- Ideal interface for PLC and electronic systems
- AC coils & DC coils
- Instant ejection of relay using plastic retaining clip
- Supply status indication and coil suppression module
- Identification labels
- 35 mm rail (EN 50022) mounting

49.61  
Screw terminal



49.81-20x0/40x0  
Screwless terminal



For outline drawing see page 8

### Contact specification

	49.61/81-20x0	49.61/81-40x0
Contact configuration	1 CO (SPDT)	1 CO (SPDT)
Rated current/Maximum peak current A	16*/30	16*/100 (5 ms)
Rated voltage/Maximum switching voltage V AC	250/400	250/400
Rated load AC1 VA	4,000	4,000
Rated load AC15 (230 V AC) VA	750	750
Single phase motor rating (230 V AC) kW	0.55	0.55
Breaking capacity DC1: 30/110/220V A	16/0.3/0.12	16/0.3/0.12
Minimum switching load mW (V/mA)	500 (5/5)	1,000 (10/10)
Standard contact material	AgCdO	AgSnO <sub>2</sub>

### Coil specification

	49.61/81-20x0	49.61/81-40x0
Nominal voltage (U <sub>N</sub> ) V AC (50/60 Hz)	12 - 24 - 110 - 120 - 230	12 - 24 - 110 - 120 - 230
V DC	12 - 24 - 125	12 - 24 - 125
Rated power AC/DC/sens.DC VA (50 Hz)/W/W	1.2/0.65/0.5	1.2/0.65/0.5
Operating range AC	(0.8...1.1)U <sub>N</sub>	(0.8...1.1)U <sub>N</sub>
DC/sensitiv DC	(0.73...1.5)U <sub>N</sub> /(0.8...1.5)U <sub>N</sub>	(0.73...1.5)U <sub>N</sub> /(0.8...1.5)U <sub>N</sub>
Holding voltage AC/DC	0.8 U <sub>N</sub> / 0.4 U <sub>N</sub>	0.8 U <sub>N</sub> / 0.4 U <sub>N</sub>
Must drop-out voltage AC/DC	0.2 U <sub>N</sub> / 0.1 U <sub>N</sub>	0.2 U <sub>N</sub> / 0.1 U <sub>N</sub>

### Technical data

	49.61/81-20x0	49.61/81-40x0
Mechanical life AC/DC cycles	10 · 10 <sup>6</sup> /20 · 10 <sup>6</sup>	10 · 10 <sup>6</sup> /20 · 10 <sup>6</sup>
Electrical life at rated load AC1 cycles	100 · 10 <sup>3</sup>	100 · 10 <sup>3</sup>
Operate/release time ms	7/4 (AC) - 12/12 (DC)	7/4 (AC) - 12/12 (DC)
Insulation between coil and contacts (1.2/50 μs) kV	6 (8 mm)	6 (8 mm)
Dielectric strength between open contacts V AC	1,000	1,000
Ambient temperature range °C	-40...+70	-40...+70
Protection category	IP 20	IP 20

### Approvals relay (according to type)



## 49.61/81-20x0



- 1 pole, 16 A
- AgCdO contact material
- Screw terminal and screwless terminal
- 35 mm rail (EN 50022) mounting

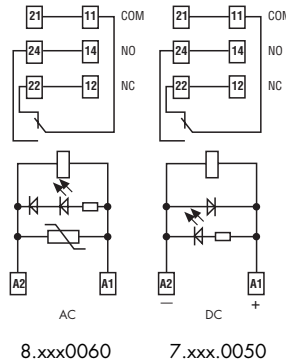

\* For currents >10 A, contact terminals must be connected in parallel (21 with 11, 24 with 14, 22 with 12).

## 49.61/81-40x0



- 1 pole, 16 A
- AgSnO<sub>2</sub> contact material
- Screw terminal and screwless terminal
- 35 mm rail (EN 50022) mounting

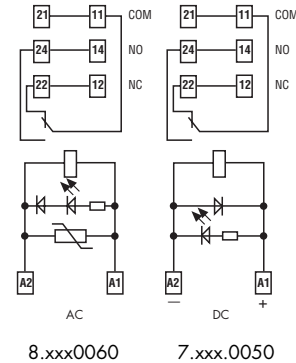

\* For currents >10 A, contact terminals must be connected in parallel (21 with 11, 24 with 14, 22 with 12).

## Ordering information

Example: 49 series, 35 mm rail (EN 50022) mount screw terminal relay interface module, 2 CO (DPDT) 8 A contacts, 24 V sensitive DC coil, green LED + diode (polarity +A1), 99.80 coil indication.

4

9

.

5

2

.

7

.

0

2

4

.

0

0

5

0

**Series** ————

**Type** ————

3, 5, 6 = 35 mm rail (EN 50022) mount, screw terminal

7, 8 = 35 mm rail (EN50022) mount, screwless terminal

**No. of poles** ————

1 = 1 pole for 49.31, 10 A  
49.61, 49.81, 16 A

2 = 2 pole for 49.52, 49.72, 8 A

**Coil version** ————

7 = Sensitive DC (500 mW)

8 = AC (50/60 Hz)

9 = DC (650 mW)

**Coil voltage** ————

See coil specifications

**A: Contact material**

0 = Standard AgNi for 49.31/52/72, AgCdO for 49.61/81

2 = AgCdO for 49.31/52/72

4 = AgSnO<sub>2</sub> for 49.61/81 only

5 = AgNi + Au (5 μm) not for 49.61/81

**B: Contact circuit**

0 = CO (nPDT)

**D: Special versions**

0 = Standard

**C: Options**

5 = Standard for DC:  
green LED + diode (polarity +A1)

6 = Standard for AC:  
green LED + Varistor

**Selecting features and options: only combinations in the same row are possible.**  
Preferred selections for best availability are shown in **bold**.

Type	Coil version	A	B	C	D
49.31/52/72	AC	<b>0</b> - 2 - 5	0	<b>6</b>	0
49.31/52/72	DC	<b>0</b> - 2 - 5	0	<b>5</b>	0
49.61/81	AC	<b>0</b> - 4	0	<b>6</b>	0
49.61/81	DC	<b>0</b> - 4	0	<b>5</b>	0

## Technical data

Insulation		49.31/61	49.52/72	49.31/61/81	
Insulation according to EN 61810-1	insulation rated voltage	V	250	250	
	rated impulse withstand voltage	kV	4	4	
	pollution degree		3	2	
	overvoltage category		III	III	
Insulation between coil and contacts (1.2/50 μs)		kV	6 (8 mm)		
Dielectric strength between open contacts		V AC	1,000		
Dielectric strength between adjacent contacts		V AC	2,000 (49.52/72)		
Conducted disturbance immunity					
Burst (5...50)ns, 5 kHz, on A1 - A2		EN 61000-4-4		level 4 (4 kV)	
Surge (1.2/50 μs) on A1 - A2 (differential mode)		EN 61000-4-5		level 3 (2 kV)	
Other data					
Bounce time: NO/NC		ms	2/5		
Vibration resistance (5...55)Hz: NO/NC		g	10/4 (for 1 pole)	15/3 (for 2 pole)	
Power lost to the environment	without contact current	W	0.7		
	with rated current	W	1.2 (49.31/61/81)	1.3 (49.52/72)	
Wire strip length		mm	8		
⊕ Screw torque		Nm	0.5		
Max. wire size			Screw terminal		
			solid cable	stranded cable	
	mm <sup>2</sup>	mm	1x6 / 2x2.5	1x4 / 2x2.5	
	AWG	mm	1x10 / 2x14	1x12 / 2x14	
				Screwless terminal	
		solid cable	stranded cable		
mm <sup>2</sup>	mm	2x(0.2...1.5)	2x(0.2...1.5)		
AWG	mm	2x(24...18)	2x(24...18)		

## Contact specification

**F 49 - Electrical life (AC) v contact current**  
Types 49.31/61/81

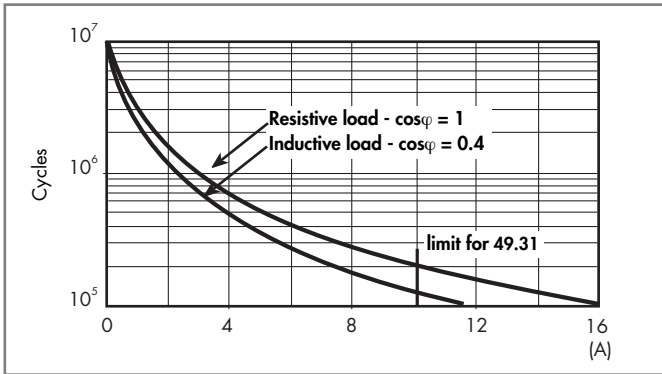

**F 49 - Electrical life (AC) v contact current**  
Types 49.52/72

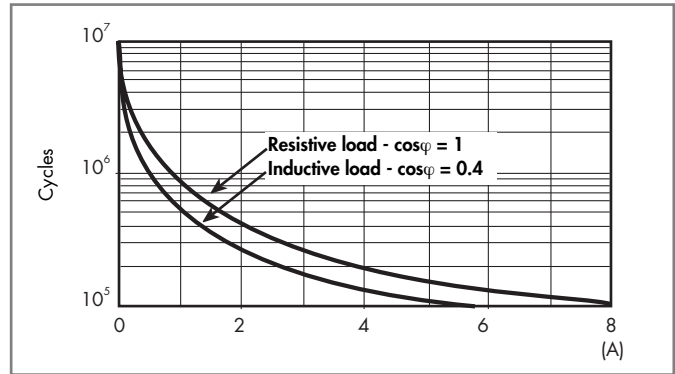

**H 49 - Maximum DC1 breaking capacity**  
Types 49.31/52/61/72/81

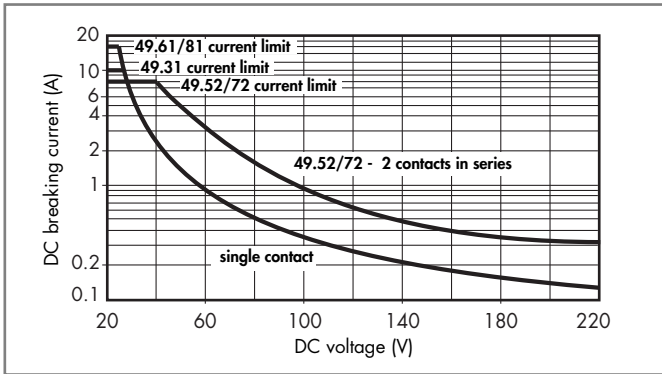

- When switching a resistive load (DC1) having voltage and current values under the curve, an electrical life of  $\geq 100 \cdot 10^3$  can be expected.
- In the case of DC13 loads, the connection of a diode in parallel with the load will permit a similar electrical life as for a DC1 load.  
Note: the release time for the load will be increased.

## Coil specifications

### DC coil data (0.5 W sensitive)

Nominal voltage $U_N$ V	Coil code	Operating range		Rated coil consumption I at $U_N$ mA
		$U_{min}^*$ V	$U_{max}^{**}$ V	
12	7.012	8.8	21	41
24	7.024	17.5	42	22.2
125	7.125	91.2	212.5	4

\* $U_{min} = 0.8 U_N$  for 49.61 and 49.81

\*\* $U_{max} = 1.5 U_N$  for 49.61 and 49.81

### AC coil data

Nominal voltage $U_N$ V	Coil code	Operating range		Rated coil consumption I at $U_N$ (50Hz) mA
		$U_{min}$ V	$U_{max}$ V	
12	8.012	9.6	13.2	90.5
24	8.024	19.2	26.4	46
110	8.110	88	121	10.1
120	8.120	96	132	11.8
230	8.230	184	253	7.0

### DC coil data (0.65 W)

Nominal voltage $U_N$ V	Coil code	Operating range		Rated coil consumption I at $U_N$ mA
		$U_{min}$ V	$U_{max}$ V	
12	9.012	8.8	18	56
24	9.024	17.5	36	29
125	9.125	91.2	187.5	6

### R 49 - DC coil operating range v ambient temperature

Standard (650 mW)

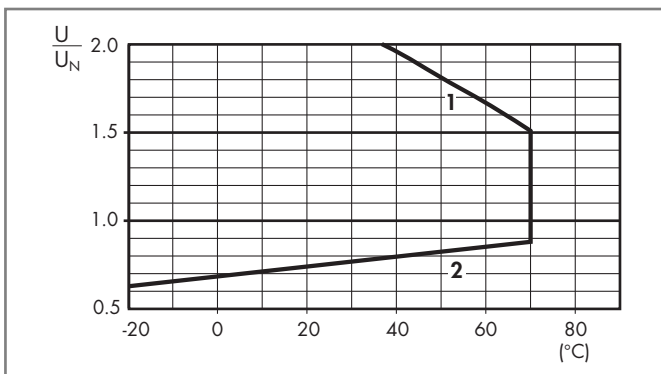

- 1 - Max. permitted coil voltage.
- 2 - Min. pick-up voltage with coil at ambient temperature.

### R 49 - AC coil operating range v ambient temperature

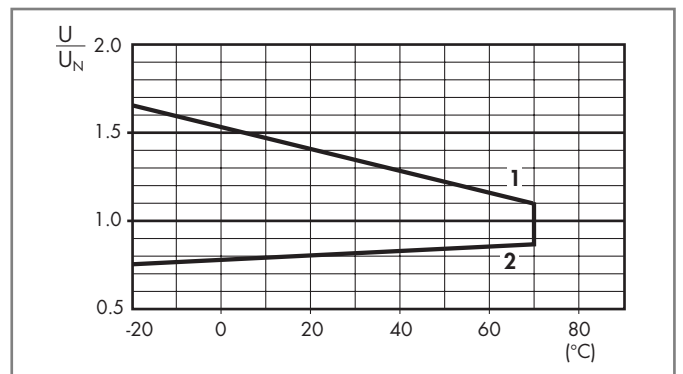

- 1 - Max. permitted coil voltage.
- 2 - Min. pick-up voltage with coil at ambient temperature.

### R 49 - DC coil operating range v ambient temperature

Sensitive coil (500 mW)

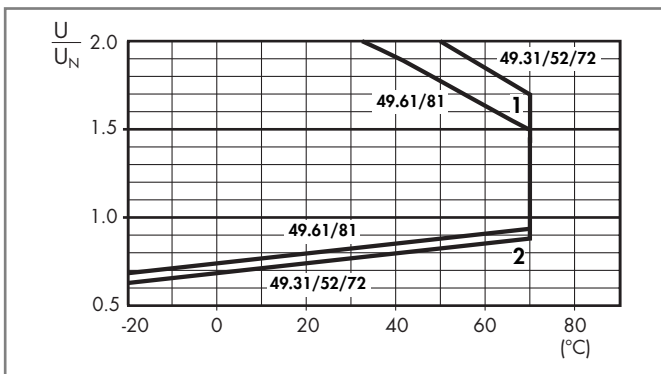

- 1 - Max. permitted coil voltage.
- 2 - Min. pick-up voltage with coil at ambient temperature.

## Combinations

Code	Type of socket	Type of relay	Module	Retaining clip
49.31	95.93.3	40.31	99.80	095.91.3
49.52	95.95.3	40.52	99.80	095.91.3
49.61	95.95.3	40.61	99.80	095.91.3
49.72	95.55.3	40.52	99.80	095.91.3
49.81	95.55.3	40.61	99.80	095.91.3

## Outline drawing

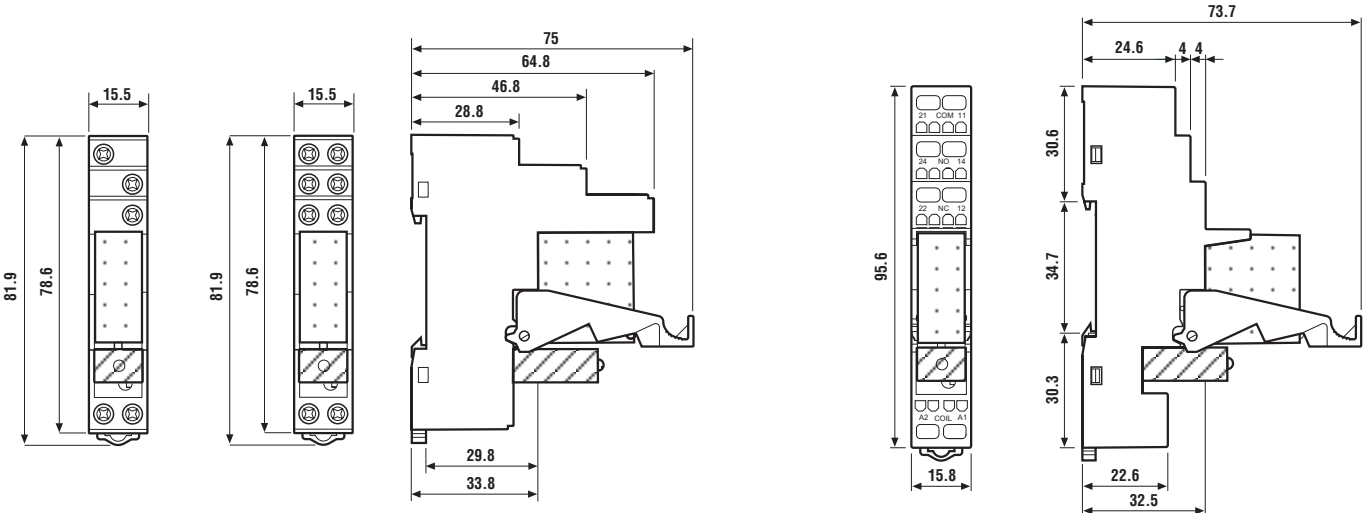

49.31                      49.52  
                                  49.61  
 49.31-50x0 / 49.31-00x0 /  
 49.31-20x0 / 49.52 / 49.61  
 Screw terminal



49.72  
 49.81  
 49.72-50x0 / 49.72-00x0 / 49.72-20x0  
 49.81-20x0 / 49.81-40x0  
 Screwless terminal



## Accessories

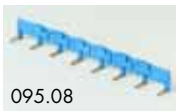

<b>8-way jumper link</b> for screw terminal versions	095.08 (blue)	095.08.0 (black)
Rated values	10 A - 250 V	

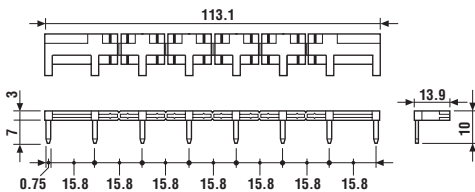

<b>Sheet of marker tags</b> , plastic, 72 tags, 6x12 mm	060.72
---	--------

## Packaging codes

How to code and identify retaining clip and packaging options for sockets.

Example:

**4 9 . 5 2 . 7 . 0 2 4 . 0 0 5 0 S P A**

