

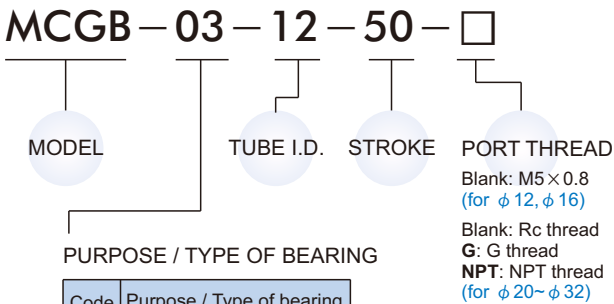

Order example



Code	Purpose / Type of bearing
03	Stop / Slide bearing
23*	Push / Linear bush bearing

※ Could attach a table for the use as a lifter.

Features

- Proven track record in manufacturing precision guided cylinders.
- Multi-Ports as standard enabling two direction mounting option.
- Flush fitting sensors.
- Inbuilt high density rubber pad absorbs energy at the end of stroke.
- Magnetic as standard.

Specification

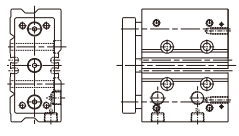
Model	MCGB	
Model		
Acting type	Double acting	
Tube I.D.(mm)	12, 16	20, 25, 32
Port size	M5×0.8	Rc1/8
Medium	Air	
Operating pressure range	0.1~1 MPa	
Proof pressure	1.5 MPa	
Ambient temperature	-5~+60°C (No freezing)	
Cushion	With rubber cushion pad	
Available speed range	50~500mm/sec	
Lubrication	Not required	
Sensor switch (※)	RCE, RCE1, RDEP	

※ RCE, RCE1, RDEP specification, please refer to page 8-10, 15.

Installation of sensor switch

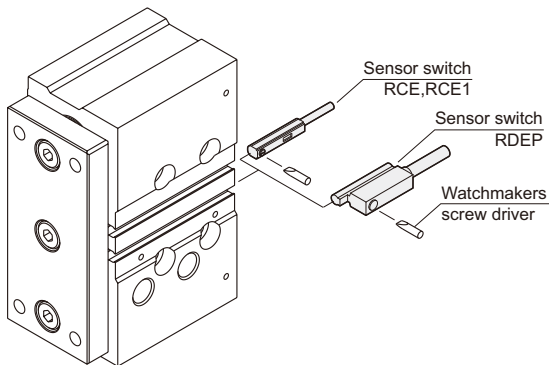

Table for standard stroke

Series variety	Bearing type	Tube I.D.	Stroke (mm)													
			10	20	25	30	40	50	75	100	125	150	175	200		
MCGB-03	Slide bearing	φ 12														
		φ 16														
		φ 20														
		φ 25														
		φ 32*														
MCGB-23	Linear bush bearing	φ 12														
		φ 16														
		φ 20														
		φ 25														
		φ 32														

- ※ 1. MCGB-03 ~ Tube I.D. φ 32: 25mm for the shortest standard stroke.
2. Please consult us if stroke out of specification.

Capacity graph

Capacity for the use as a stopper~

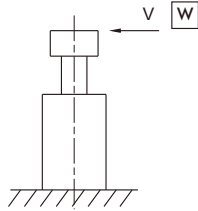

Linear bush bearing type is not available as a stopper.

Stop capacity

MCGB-03...30st

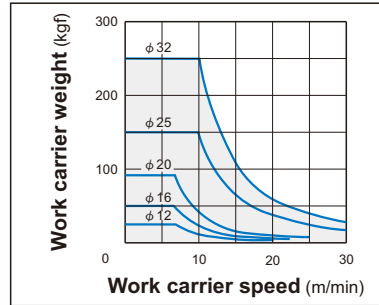

Normal lateral load

MCGB-03...30st

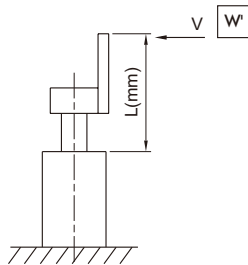
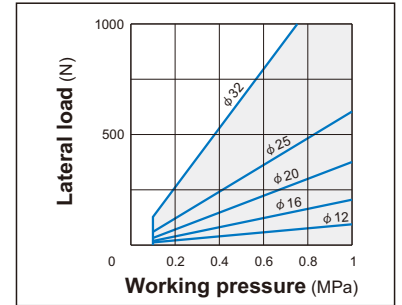

For the use of attaching a plate to the link bar, choose a bore size referring to the formula below.

Coefficients for conversion

$$W = W' \times \frac{L}{\ell}$$

MCGB series	$\phi 12$	$\phi 16$	$\phi 20$	$\phi 25$	$\phi 32$
ℓ	40	42	42	42	44

W: The maximum weight of the work carrier in the above graph for the stopper's capacity.

Capacity for the use as a lifter~

Allowable eccentricity load for the use as a lifter (at supply pressure 0.5MPa)

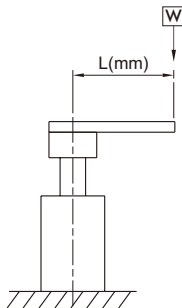

Show the dynamic allowable value at L(mm) eccentricity from the center of the guide rod.

Slide bearing

MCGB-03...10-50st

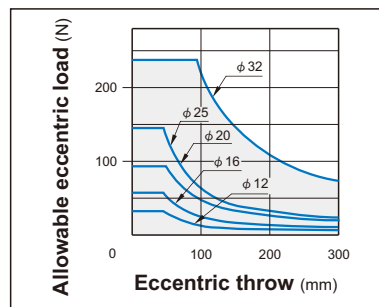

Slide bearing

MCGB-03...75-200st

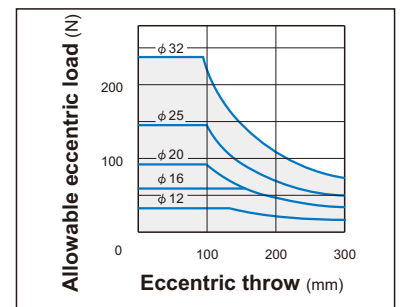

Linear bush bearing

MCGB-23...10-50st

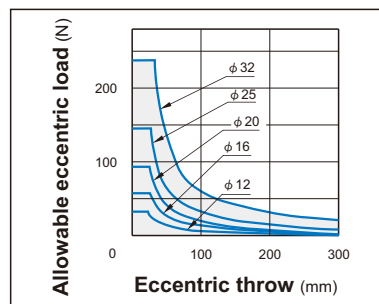

Linear bush bearing

MCGB-23...75-200st

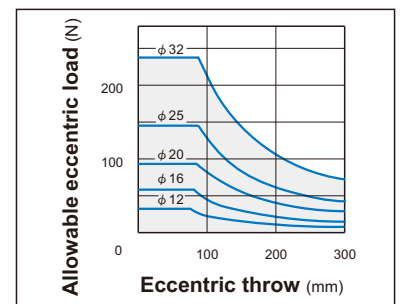

Capacity table

Unit: N

Allowable lateral load

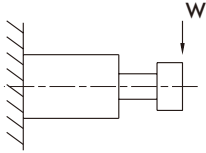

Shows the dynamic allowable value, when actuating the cylinder with lateral load W at the guide rods' top (vertical load against the guide rods).

Tube I.D.	Bearing type	Stroke (mm)											
		10	20	25	30	40	50	75	100	125	150	175	200
$\phi 12$	Slide bearing	31	24	/	19	16	13	37	31	/	/	/	/
	Linear bush bearing	23	17	/	14	34	30	23	19	/	/	/	/
$\phi 16$	Slide bearing	50	39	/	32	27	24	54	45	/	/	/	/
	Linear bush bearing	36	29	/	24	59	52	40	33	/	/	/	/
$\phi 20$	Slide bearing	/	51	/	44	39	35	54	46	74	66	59	54
	Linear bush bearing	/	43	/	36	98	87	69	57	46	40	36	32
$\phi 25$	Slide bearing	/	68	/	59	52	46	72	61	98	88	79	72
	Linear bush bearing	/	67	/	56	148	132	105	87	70	62	55	50
$\phi 32$	Slide bearing	/	/	165	/	/	129	106	90	138	123	111	101
	Linear bush bearing	/	/	104	/	/	74	165	138	114	100	90	81

Allowable rotating torque

Unit: N.m

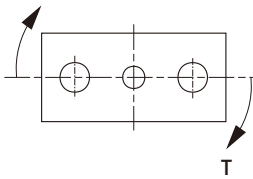

Shows the dynamic allowable value, when actuating the cylinder with a rotating torque T at the guide rods' top.

Tube I.D.	Bearing type	Stroke (mm)											
		10	20	25	30	40	50	75	100	125	150	175	200
$\phi 12$	Slide bearing	0.64	0.48	/	0.39	0.32	0.28	0.75	0.63	/	/	/	/
	Linear bush bearing	0.47	0.35	/	0.29	0.71	0.62	0.4	0.38	/	/	/	/
$\phi 16$	Slide bearing	1.14	0.9	/	0.74	0.63	0.55	1.23	1.04	/	/	/	/
	Linear bush bearing	0.84	0.66	/	0.54	1.35	1.19	0.93	1.76	/	/	/	/
$\phi 20$	Slide bearing	/	1.14	/	1.21	1.07	0.95	1.49	1.25	2.03	1.81	1.63	1.48
	Linear bush bearing	/	1.19	/	0.99	2.69	2.4	1.89	1.56	1.26	1.1	0.98	0.88
$\phi 25$	Slide bearing	/	2.19	/	1.88	1.65	1.47	2.31	1.94	3.15	2.8	2.52	2.3
	Linear bush bearing	/	2.14	/	1.79	4.74	4.22	3.36	2.78	2.25	1.98	1.76	1.59
$\phi 32$	Slide bearing	/	/	6.61	/	/	5.16	4.23	3.59	5.52	4.93	4.45	4.06
	Linear bush bearing	/	/	4.17	/	/	2.95	6.6	5.52	4.56	4.02	3.59	3.24

Anti-roll accuracy

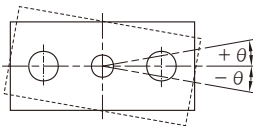

- The values are the deflection angle against the piston rod.
- Exclusive factor of the guide rods' deflection.

Tube I.D.	Bearing type	Anti-roll accuracy
		θ
$\phi 12$	Slide bearing	$\pm 0.09^\circ$
	Linear bush bearing	$\pm 0.06^\circ$
$\phi 16$	Slide bearing	$\pm 0.08^\circ$
	Linear bush bearing	$\pm 0.06^\circ$
$\phi 20$	Slide bearing	$\pm 0.08^\circ$
	Linear bush bearing	$\pm 0.03^\circ$
$\phi 25$	Slide bearing	$\pm 0.07^\circ$
	Linear bush bearing	$\pm 0.05^\circ$
$\phi 32$	Slide bearing	$\pm 0.07^\circ$
	Linear bush bearing	$\pm 0.03^\circ$

MCGB-03 Inside structure & Parts list

TWIN-GUIDE CYLINDER

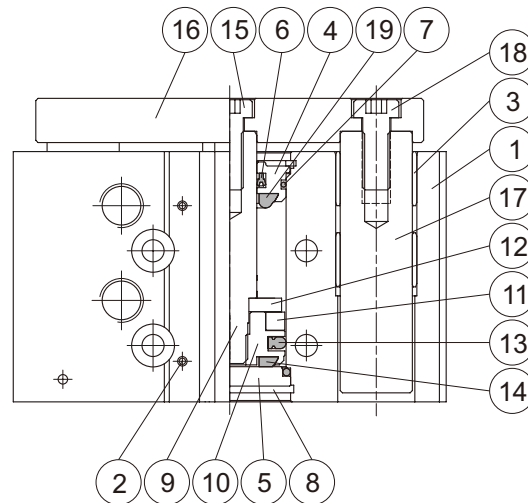

Material

No.	Part name	Tube I.D.					Q'y	Repair kits (inclusion)
		12	16	20	25	32		
1	Body	Aluminum alloy					1	
2	Ball	Stainless steel					3	
3	Slide bearing	Bronze alloy					4	
4	Rod cover	Aluminum alloy					1	
5	Head cover	※	Carbon steel				1	
6	Rod packing	NBR					1	●
7	Cover ring	NBR					2	●
8	Snap ring	Spring steel					2	
9	Piston rod	Stainless steel		Carbon steel			1	
10	Piston	Aluminum alloy					1	
11	Magnet ring	Magnet material					1	
12	Magnet holder	Stainless steel					1	
13	Piston packing	NBR					1	●
14	Head cushion	NBR					1	●
15	Bolt	SCM					1	
16	Plate	Carbon steel					1	
17	Guide rod	Carbon steel					2	
18	Screw	SCM					2	
19	Rod cushion	NBR					1	●



※ Aluminum alloy

Order example of repair kits

Tube I.D.	Repair kits
φ 12	PS-MCGB-12
φ 16	PS-MCGB-16
φ 20	PS-MCGB-20
φ 25	PS-MCGB-25
φ 32	PS-MCGB-32

Cylinder weight

Unit: g

Model	Basic weight MCGB-03	Stroke 5 mm MCGB-03
Tube I.D.		
φ 12	191	21
φ 16	283	28
φ 20	450	45
φ 25	670	63
φ 32	1,210	90

MCGB-23 Inside structure & Parts list

TWIN-GUIDE CYLINDER

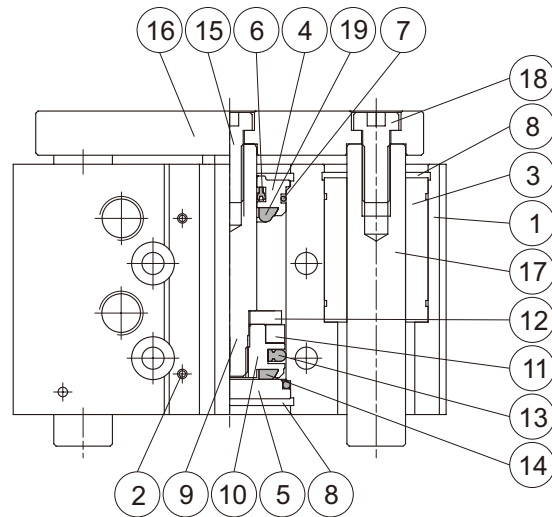

Material

No.	Part name	Tube I.D.					Q'y	Repair kits (inclusion)
		12	16	20	25	32		
1	Body	Aluminum alloy					1	
2	Ball	Stainless steel					3	
3	Linear bush bearing	—					4	
4	Rod cover	Aluminum alloy					1	
5	Head cover	※1	Carbon steel				1	
6	Rod packing	NBR					1	●
7	Cover ring	NBR					2	●
8	Snap ring	Spring steel					2	
9	Piston rod	Stainless steel		※2			1	
10	Piston	Aluminum alloy					1	
11	Magnet ring	Magnet material					1	
12	Magnet holder	Stainless steel					1	
13	Piston packing	NBR					1	●
14	Head cushion	NBR					1	●
15	Bolt	SCM					1	
16	Plate	Carbon steel					1	
17	Guide rod	Special steel					2	
18	Screw	SCM					2	
19	Rod cushion	NBR					1	●

※1. Aluminum alloy



※2. Carbon steel

Order example of repair kits

Tube I.D.	Repair kits
φ 12	PS-MCGB-12
φ 16	PS-MCGB-16
φ 20	PS-MCGB-20
φ 25	PS-MCGB-25
φ 32	PS-MCGB-32

Cylinder weight

Unit: g

Model	Basic weight MCGB-23	Stroke 5 mm MCGB-23
Tube I.D.		
φ 12	211	18
φ 16	260	30
φ 20	470	45
φ 25	740	60
φ 32	1,170	85

MCGB-03/MCGB-23

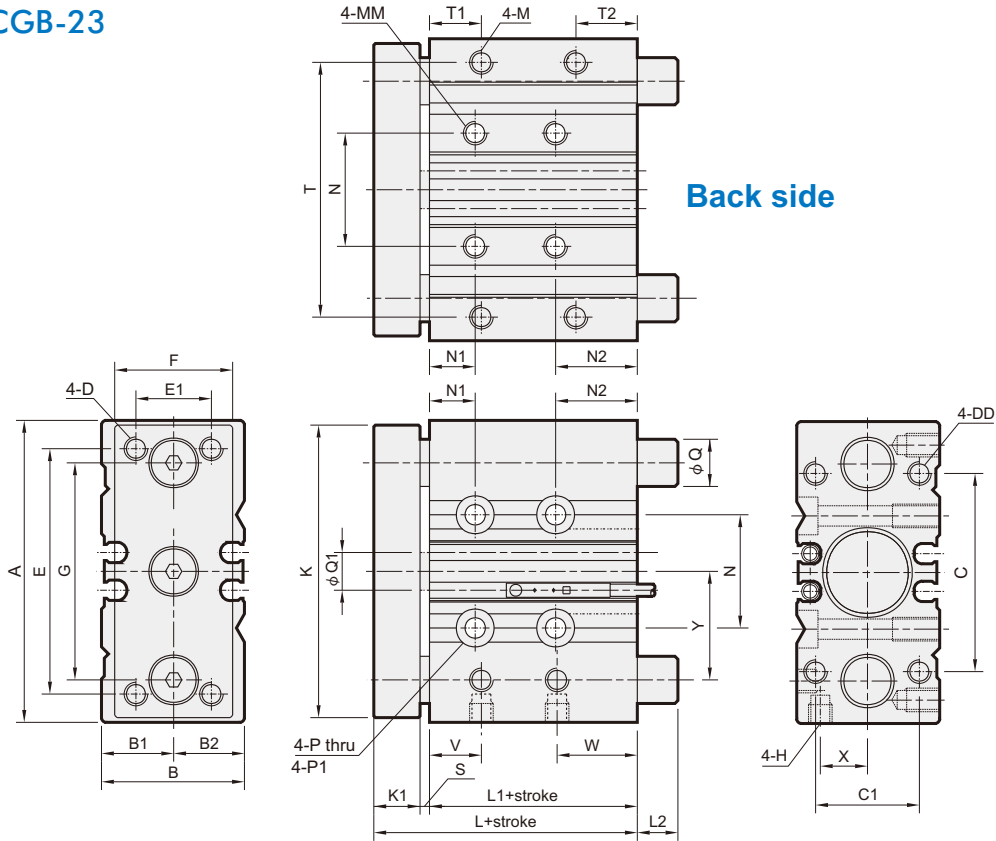

MCGB-03/MCGB-23

Code Tube I.D.	A	B	B1	B2	C	C1	D	DD	E	E1	F	G	H	K	K1	L	L1	L2	M	MM	N	N1	N2	P
12	58	26	13	13	40	18	M4 × 0.7	M4 × 0.7 × 9dp	48	14	22	41.5	M5 × 0.8	56	8	39	29		M4 × 0.7 × 7dp	M5 × 0.8 × 10dp	23	5	20	$\phi 4.3$
16	64	30	15	15	42	22	M5 × 0.8	M5 × 0.8 × 11dp	52	16	25	46	M5 × 0.8	62	10	43	31		M5 × 0.8 × 8dp	M5 × 0.8 × 10dp	24	5	22	$\phi 4.3$
20	85	36	17	19	52	26	M5 × 0.8	M5 × 0.8 × 13dp	60	18	30	55	Rc1/8	72	10	47	35	*	M5 × 0.8 × 7dp	M6 × 1.0 × 12dp	28	19	16	$\phi 5.3$
25	96	42	21	21	62	32	M6 × 1.0	M6 × 1.0 × 15dp	70	26	38	65	Rc1/8	86	10	47.5	35.5		M6 × 1.0 × 9dp	M6 × 1.0 × 12dp	34	22	12.5	$\phi 5.3$
32	116	51	26	25	80	38	M8 × 1.25	M8 × 1.25 × 18dp	96	30	48	80	Rc1/8	112	12	47.5	33.5		M8 × 1.25 × 11dp	M8 × 1.25 × 16dp	42	22	14.5	$\phi 6.6$

Code Tube I.D.	P1	Q		Q1	S	T	T1	T2	V	W	X	Y
		MCGB-03	MCGB-23									
12	$\phi 8 \times 4.5dp$	8	6	6	2	50	12	12	11	15	8.5	19.5
16	$\phi 8 \times 4.5dp$	10	8	8	2	54	11	13	11	17	10	23
20	$\phi 9.5 \times 5.5dp$	12	10	10	2	64	11	14	12	23	11.5	24.5
25	$\phi 9.5 \times 5.5dp$	16	13	12	2	76	12	13.5	11	23.5	13.5	24
32	$\phi 11 \times 6.5dp$	20	16	16	2	100	12	16.5	11.5	25	16	31

* L2 dimensions list

MCGB-03

Tube I.D.	Stroke (mm)											
	10	20	25	30	40	50	75	100	125	150	175	200
12	0	0	/	0	0	0	18	18	/	/	/	/
16	0	0	/	0	0	0	21	21	/	/	/	/
20	/	0	/	0	0	0	14	14	31	31	31	31
25	/	0	/	0	0	0	14	14	31	31	31	31
32	/	/	20	20	20	20	20	20	42	42	42	42

MCGB-23

Tube I.D.	Stroke (mm)											
	10	20	25	30	40	50	75	100	125	150	175	200
12	0	0	/	0	14	14	14	14	/	/	/	/
16	0	0	/	0	21	21	21	21	/	/	/	/
20	/	0	/	0	27	27	27	27	50	50	50	50
25	/	2	/	2	35	35	35	35	50	50	50	50
32	/	/	8	8	8	8	42	42	55	55	55	55