

MONO

the power to innovate

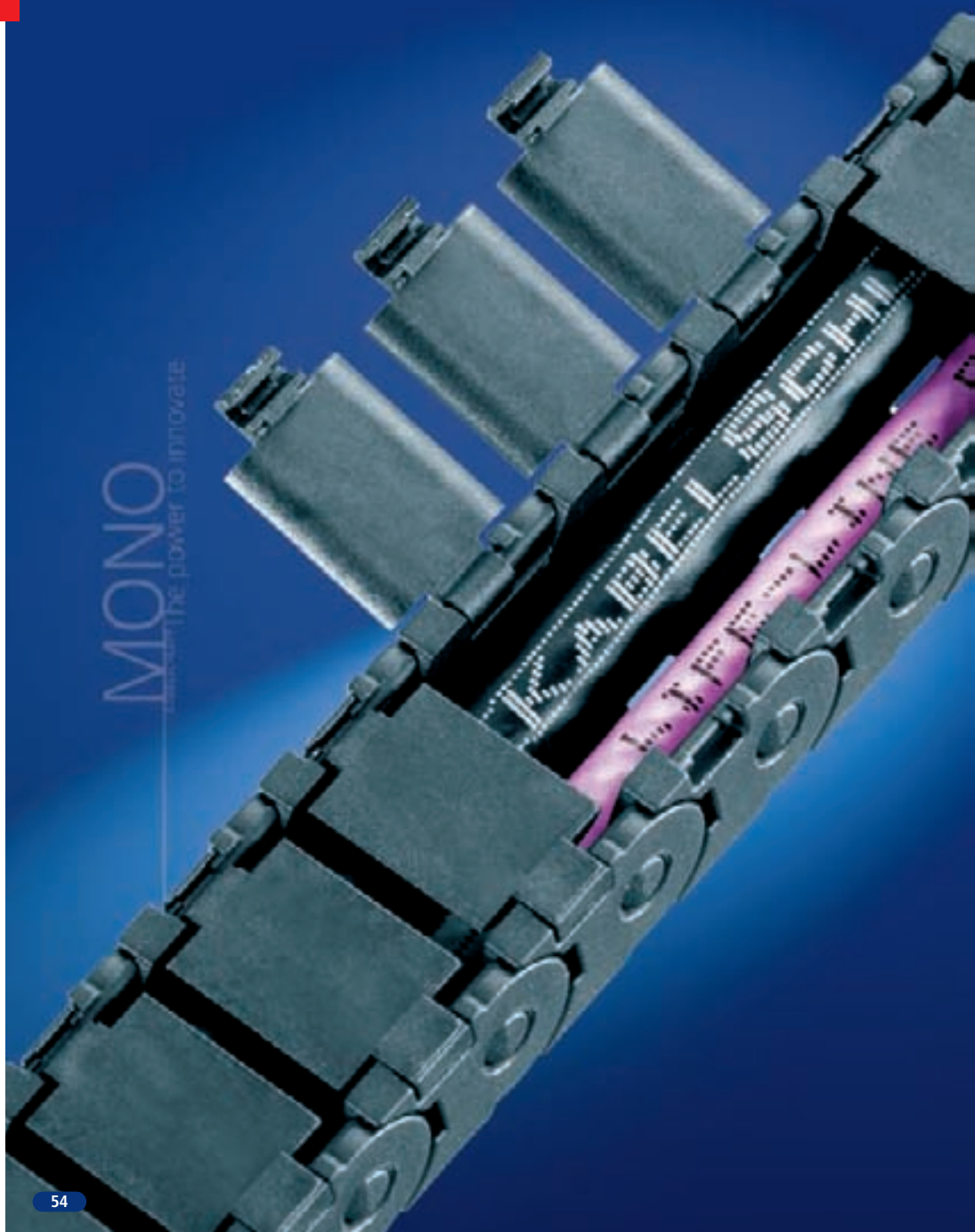

MONO

Cable carriers with simple design for standard applications*

- Cost-effective cable carrier
- Simple and quick assembly
- Almost all types available immediately ex stock all around the world
- TÜV design approved in accordance with 2PFG 1036/10.97

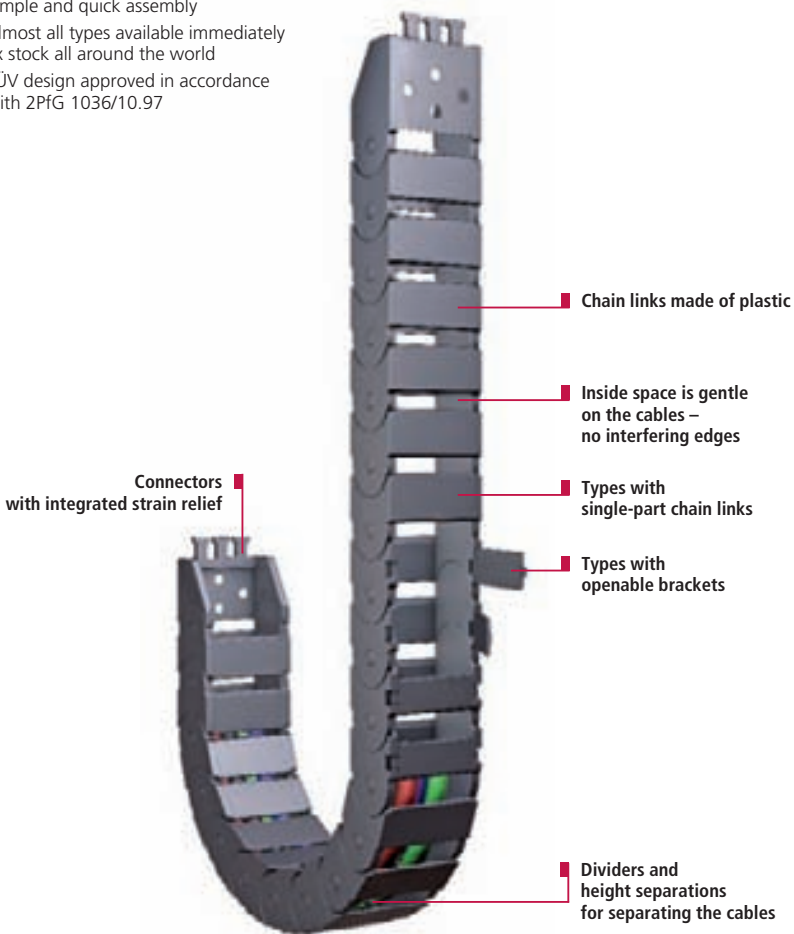

Inside heights



Inside widths



kabelschlepp.de

Fon: +49 2762 4003-0



Small types for restricted installation conditions



Fast shortening/extending due to simple connection of the chain links



Different connection options by simply changing the connectors

OnlineEngineer.de
KABELSCHLEPP
 Cable Carrier Configurator

Subject to change.

* Some features can be different for certain types for design reasons. Our specialists are happy to advise you.

Overview MONO

Inside heights



Inside widths



kabelschlepp.de

Fon: +49 2762 4003-0

Use our free project planning service.

Types 0130, 0180 with hinged, openable brackets



Type	h _i	B _i	Maximum travel length in m	Dynamics of unsupported arrangement		Page
				Travel speed v _{max} in m/s	Travel acceleration a _{max} in m/s ²	
0130	10	6-40	40	10	50	58
0180	15	10-40	70	10	50	60

Dimensions in mm

Types 0132, 0202, 0182 with fixed brackets



Type	h _i	B _i	Maximum travel length in m	Dynamics of unsupported arrangement		Page
				Travel speed v _{max} in m/s	Travel acceleration a _{max} in m/s ²	
0132	10	6-40	40	10	50	58
0182	15	10-40	70	10	50	60
0202	11	6-20	70	10	50	62

Dimensions in mm

Type 0320 with fixed brackets



Type	h _i	B _i	Maximum travel length in m	Dynamics of unsupported arrangement		Page
				Travel speed v _{max} in m/s	Travel acceleration a _{max} in m/s ²	
0320	19	13-37	80	10	50	64

Dimensions in mm

Overview MONO

Type 0450 with hinged, openable or fixed brackets

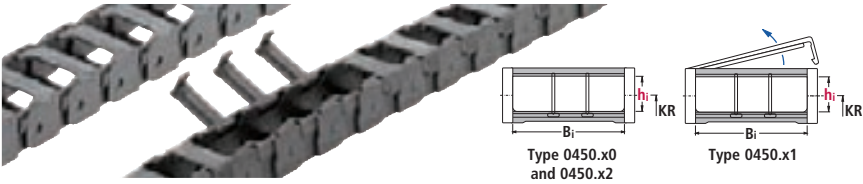

Inside heights



Inside widths



Type	h _i	B _i	Maximum travel length in m	Dynamics of unsupported arrangement		Page
				Travel speed v _{max} in m/s	Travel acceleration a _{max} in m/s ²	
0450.x0	24	38-103	120	10	50	66
0450.x1	24	38-103	120	10	50	66
0450.x2	28	38-103	120	10	50	66

Dimensions in mm

Type 0625 with hinged, openable or fixed brackets



kabelschlepp.de

Type	h _i	B _i	Maximum travel length in m	Dynamics of unsupported arrangement		Page
				Travel speed v _{max} in m/s	Travel acceleration a _{max} in m/s ²	
0625.22/40/42	34	65-108	130	8	40	70
0625.23/43	34	65-108	130	8	40	70
0625.x5	42	65-169	130	8	40	70

Font: +49 2762 4003-0

OnlineEngineer.de
 Web-Configurator
 Cable Carrier Configurator

Types 0132 and 0130

Inside height



Inside widths



Type 0132

Inside/Outside: Not to be opened

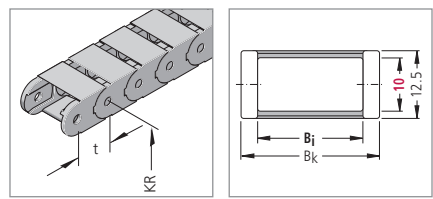

Type 0130

Outside: Hinged, openable brackets

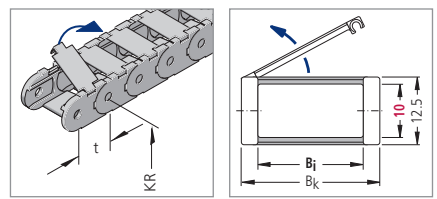

Dimensions and intrinsic chain weight

Type	h _i mm	B _i mm	B _k mm	Intrinsic chain weight kg/m
0132.06	10	6	12	0.13
0132.10	10	10	16	0.14
0132.15	10	15	21	0.15
0132.20	10	20	26	0.16
0132.30	10	30	36	0.18
0132.40	10	40	46	0.20

Type	h _i mm	B _i mm	B _k mm	Intrinsic chain weight kg/m
0130.06	10	6	12	0.13
0130.10	10	10	16	0.14
0130.15	10	15	21	0.15
0130.20	10	20	26	0.16
0130.40	10	40	46	0.20

kabelschlepp.de

Bend radius and pitch

Types 0132 and 0130

Bend radii KR mm		
20	28	37

Pitch t = 13.0 mm

Load diagram

for unsupported length L_f depending on the additional load

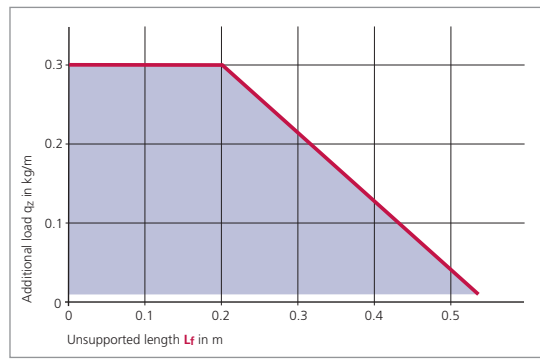

Unsupported length L_f

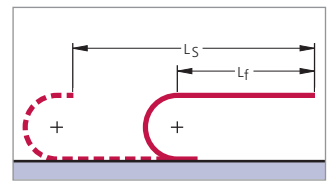

In the case of longer travel lengths, sag of the cable carriers is technically permissible depending on the application.

In a gliding arrangement, even longer travel lengths are possible (see page 295).

We are at your service to advise on these applications.

Example of ordering

Cable carrier **0130** - **10** - **28** - **390** Connection **FA/MA**

Type Inside width B_i in mm Bend radius KR in mm Chain length L_k in mm (without connection) Connection Fixed point/Driver

Use our free project planning service.

Types 0132 and 0130

Connection dimensions

Plastic connectors with integrated strain relief

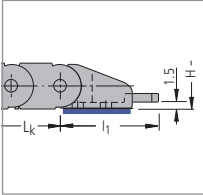

Short connectors without strain relief are also available for restricted installation conditions. Please contact us.

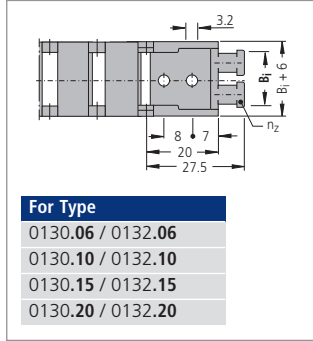

For Type
0130.06 / 0132.06
0130.10 / 0132.10
0130.15 / 0132.15
0130.20 / 0132.20

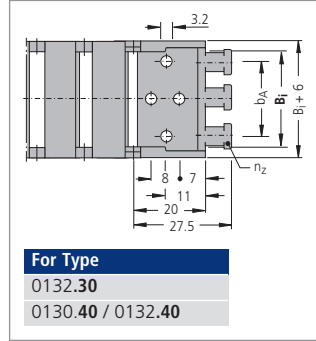

For Type
0132.30
0130.40 / 0132.40

Type	B _i mm	B _k mm	b _A mm	n _Z
0130.06 / 0132.06	6	12	–	1
0130.10 / 0132.10	10	16	–	1
0130.15 / 0132.15	15	21	–	2
0130.20 / 0132.20	20	26	–	2
0132.30	30	36	22	3
0130.40 / 0132.40	40	46	32	4

The dimensions of the fixed point and driver connections are identical.

Inside height



Inside widths



kabelschlepp.de

Fon: +49 2762 4003-0

Connection variants

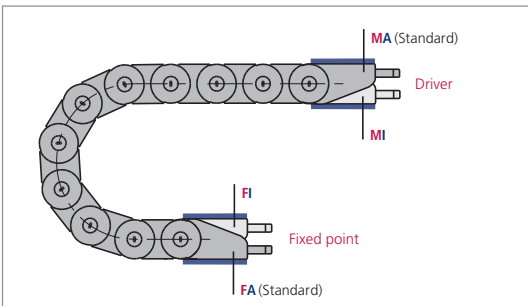

Connection point

- M – Driver
- F – Fixed point

Connection type

- A – Threaded joint outside (standard)
- I – Threaded joint inside

In the standard version, the connectors are mounted with the threaded joint outwards (FA/MA).

When ordering please specify the desired connection type (see ordering key on page 332).

The connection type can subsequently be altered simply by varying the connectors.

Types 0182 and 0180

Inside height



Inside widths



Type 0182

Inside/Outside: Not to be opened

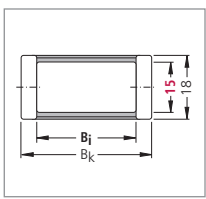
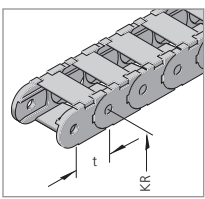

Type 0180

Outside: Hinged, openable brackets

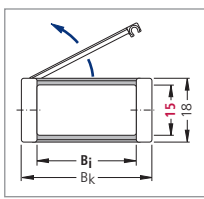
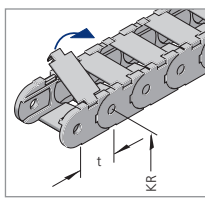

Dimensions and intrinsic chain weight

Type	hi mm	Bi mm	Bk mm	Intrinsic chain weight kg/m
0182.10	15	10	18	0.23
0182.15	15	15	23	0.24
0182.20	15	20	28	0.25
0182.30	15	30	38	0.28
0182.40	15	40	48	0.30

Type	hi mm	Bi mm	Bk mm	Intrinsic chain weight kg/m
0180.10	15	10	18	0.23
0180.15	15	15	23	0.24
0180.20	15	20	28	0.25
0180.30	15	30	38	0.28
0180.40	15	40	48	0.30

kabelschlepp.de

Bend radius and pitch

Types 0182 and 0180

Bend radii KR mm		
28	37	50

Pitch t = 18.0 mm

Load diagram

for unsupported length L_f depending on the additional load

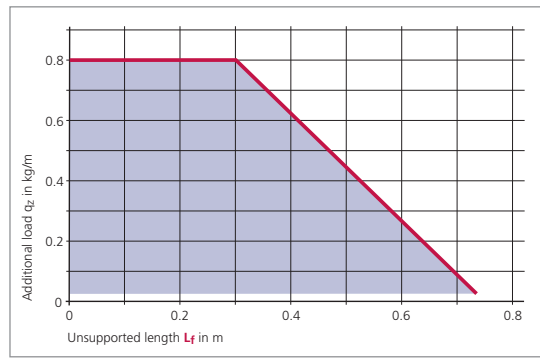

Unsupported length L_f

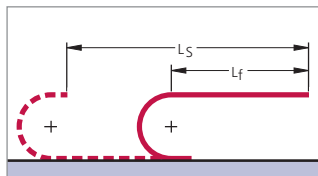

In the case of longer travel lengths, sag of the cable carriers is technically permissible depending on the application.

In a gliding arrangement, even longer travel lengths are possible (see page 295).

We are at your service to advise on these applications.

Fon: +49 2762 4003-0

Use our free project planning service.

Example of ordering

Cable carrier	0180	-	30	-	37	-	720	Connection	FA/MA
Type	Inside width Bi in mm		Bend radius KR in mm		Chain length Lk in mm (without connection)		Connection Fixed point/Driver		

Types 0182 and 0180

Connection dimensions

Plastic connectors with integrated strain relief

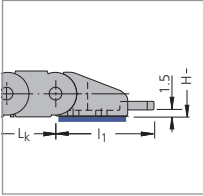

Short connectors without strain relief are also available for restricted installation conditions. Please contact us.

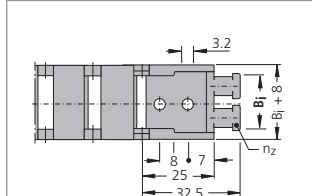

For Type

0180.10 / 0182.10
0180.15 / 0182.15
0180.20 / 0182.20

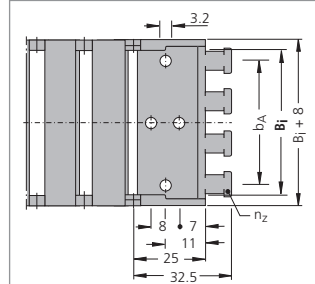

For Type

0180.30 / 0182.30
0180.40 / 0182.40

Type	B _i mm	B _k mm	b _A mm	n _Z
0180.10 / 0182.10	10	18	–	1
0180.15 / 0182.15	15	23	–	2
0180.20 / 0182.20	20	28	–	2
0180.30 / 0182.30	30	38	22	3
0180.40 / 0182.40	40	48	32	4

The dimensions of the fixed point and driver connections are identical.

Inside height

15

Inside widths

10

40

kabelschlepp.de

Fon: +49 2762 4003-0

Connection variants

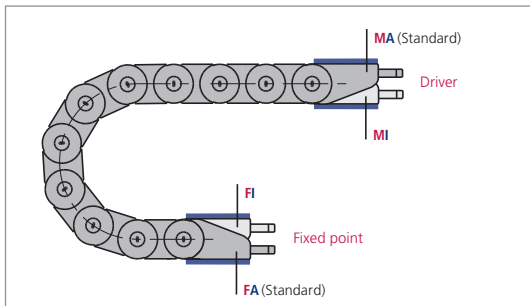

Connection point

- M – Driver
- F – Fixed point

Connection type

- A – Threaded joint outside (standard)
- I – Threaded joint inside

In the standard version, the connectors are mounted with the threaded joint outwards (FA/MA).

When ordering please specify the desired connection type (see ordering key on page 332).

The connection type can subsequently be altered simply by varying the connectors.

Type 0202

Inside/Outside: Not to be opened

Inside height



Inside widths

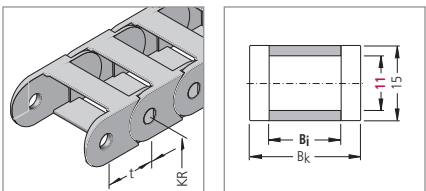

Dimensions and intrinsic chain weight

Type	h _i mm	B _i mm	B _k mm	Intrinsic chain weight kg/m
0202.06	11	6	13	0.14
0202.10	11	10	17	0.15
0202.15	11	15	22	0.16
0202.20	11	20	27	0.17

Bend radius and pitch

Bend radii KR mm			
18	28	38	50

Pitch t = 20.0 mm

kabelschlepp.de

Fon: +49 2762 4003-0

Use our free project planning service.

Load diagram

for unsupported length L_f depending on the additional load

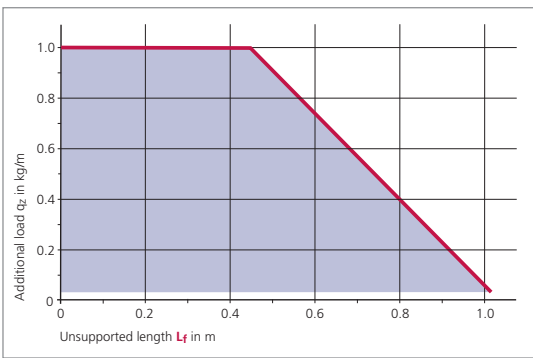

Unsupported length L_f

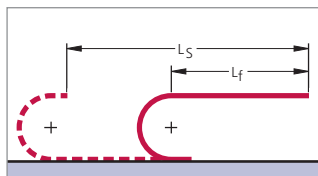

In the case of longer travel lengths, sag of the cable carriers is technically permissible depending on the application.

In a gliding arrangement, even longer travel lengths are possible (see page 295).

We are at your service to advise on these applications.

Example of ordering

Cable carrier	0202	-	10	-	28	-	460	Connection	FA/MA
Type	Inside width B _i in mm		Bend radius KR in mm		Chain length L _k in mm (without connection)		Connection Fixed point/Driver		

Type 0202

Connection dimensions

Plastic connectors
with integrated strain relief

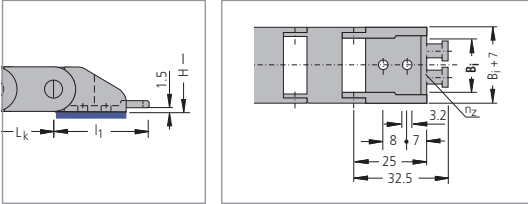

Type	B _i mm	B _k mm	n _Z
0202.06	6	13	1
0202.10	10	17	1
0202.15	15	22	2
0202.20	20	27	2

The dimensions of the fixed point and driver connections are identical.

Connection variants

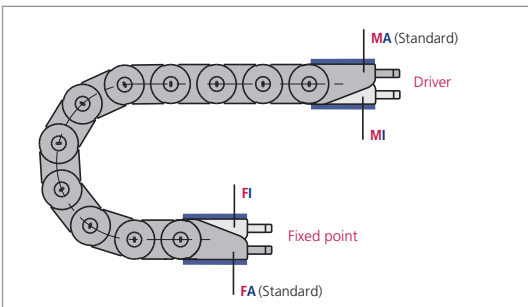

Connection point

- M** – Driver
- F** – Fixed point

Connection type

- A** – Threaded joint outside (standard)
- I** – Threaded joint inside

In the standard version, the connectors are mounted with the threaded joint outwards (**FA/MA**).

When ordering please specify the desired connection type (see ordering key on page 332).

The connection type can subsequently be altered simply by varying the connectors.

Inside height



Inside widths



kabelschlepp.de

Fon: +49 2762 4003-0

OnlineEngineer.de
with CableS
Cable Center Configurator

Type 0320

Inside/Outside: Not to be opened

Inside height



Inside widths

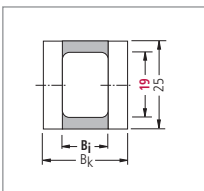
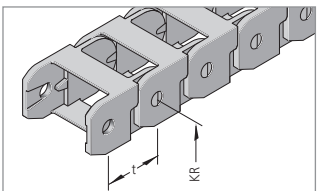

Type 0320.20 / .30

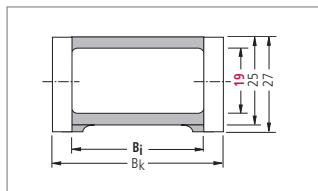

Type 0320 / .42 / .52 / .62 – with glide runners

Dimensions and intrinsic chain weight

Type 0320.20 / .30

Type	h _i mm	B _i mm	B _k mm	Intrinsic chain weight kg/m
0320.20	19	13	24	0.32
0320.30	19	19	30	0.35

Type 0320 / .42 / .52 / .62

Type	h _i mm	B _i mm	B _k mm	Intrinsic chain weight kg/m
0320.42	19	24	35	0.39
0320.52	19	29	40	0.44
0320.62	19	37	48	0.47

Bend radius and pitch

Type 0320.20 / .30

Bend radii KR mm		
37	47	77

Pitch t = 32.0 mm

Type 0320 / .42 / .52 / .62

Bend radii KR mm			
37	47	77	100

Pitch t = 32.0 mm

Load diagram

for unsupported length L_f depending on the additional load

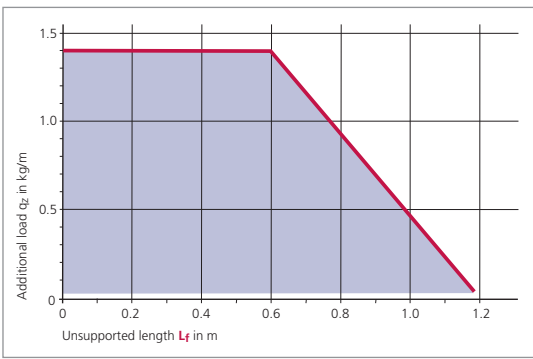

Unsupported length L_f

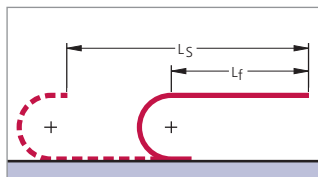

In the case of longer travel lengths, sag of the cable carriers is technically permissible depending on the application.

In a gliding arrangement, even longer travel lengths are possible (see page 295).

We are at your service to advise on these applications.

Example of ordering

Cable carrier	0320.42	-	77	-	800	Connection	FA/MA
Chain type	Bend radius KR in mm	Chain length L _k in mm (without connection)	Connection Fixed point/Driver				

kabelschlepp.de

Fon: +49 2762 4003-0

Use our free project planning service.

Type 0320

Connection dimensions

Plastic connectors
with integrated strain relief

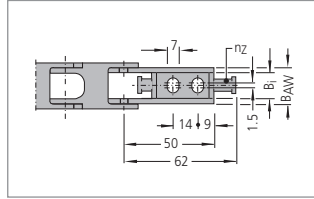
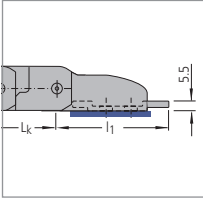

Type 0320.20

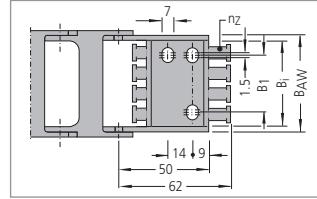

Type 0320.42 / .52 / .62

Inside
height

19

Inside
widths

13

37

Connection dimensions at
fixed point connection:

$$B_{AW} = B_i + 5.5$$

$$B_1 = B_i - 12.5$$

Connection dimensions at
driver connection:

$$B_{AW} = B_i + 11$$

$$B_1 = B_i - 10.5$$

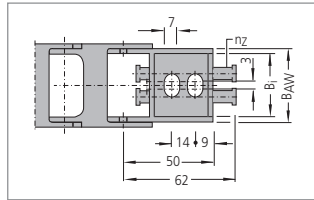

Type 0320.30

Type	B _i mm	B _k mm	n _z
0320.20	13	24	1
0320.30	19	30	2
0320.42	24	35	2
0320.52	29	40	3
0320.62	37	48	4

kabelschlepp.de

Connection variants

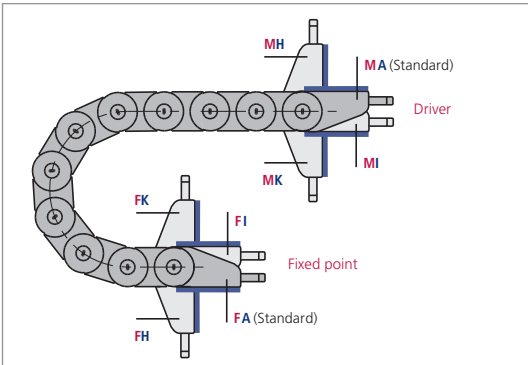

Connection point

- M – Driver
- F – Fixed point

Connection type

- A – Threaded joint outside (standard)
- I – Threaded joint inside
- H – Threaded joint, rotated through 90° to the outside
- K – Threaded joint, rotated through 90° to the inside

In the standard version, the connectors are mounted with the threaded joint outwards (FA/MA).

When ordering please specify the desired connection type (see ordering key on page 332).

The connection type can subsequently be altered simply by varying the connectors.

Fon: +49 2762 4003-0

OnlineEngineerde
with Concepts
Cable Carriers Configurator

Type 0450

Inside
heights24
-
28Inside
widths38
-
103

kabelschlepp.de

Fon:
+49 2762 4003-0Use our free
project planning service.

Inside/Outside: Not to be opened

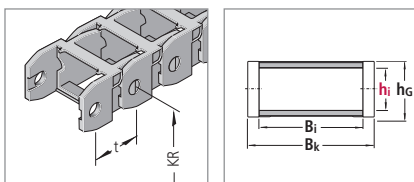

Outside: Hinged, openable and detachable brackets

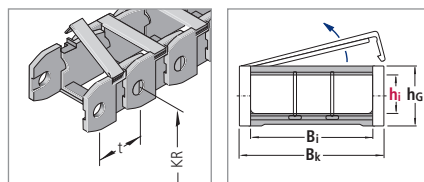

Dimensions and intrinsic chain weight

Inside/Outside:

Not to be opened – $h_i = 24$ mm

Type	h_i mm	h_G mm	B_i mm	B_k mm	Intrinsic chain weight kg/m
0450.20	24	34	38	54	0.65
0450.40	24	34	58	74	0.78
0450.60	24	34	78	94	0.92
0450.85	24	34	103	119	1.20

Outside:

Hinged, openable and detachable brackets – $h_i = 24$ mm

Type	h_i mm	h_G mm	B_i mm	B_k mm	Intrinsic chain weight kg/m
0450.21	24	40	38	54	0.75
0450.41	24	40	58	74	0.85
0450.61	24	40	78	94	0.92
0450.81	24	40	103	119	1.20

Inside/Outside:

Not to be opened – $h_i = 28$ mm

Type	h_i mm	h_G mm	B_i mm	B_k mm	Intrinsic chain weight kg/m
0450.22	28	40	38	54	0.75
0450.32	28	40	48	64	0.80
0450.42	28	40	58	74	0.85
0450.62	28	40	78	94	0.95
0450.82	28	40	103	119	1.10

Bend radius and pitch

Inside/Outside:

Not to be opened – $h_i = 24$ mm

Bend radii KR mm				
52	94	125	150	200

Pitch $t = 45.0$ mm

Outside:

Hinged, openable and detachable brackets – $h_i = 24$ mm

Bend radii KR mm				
52	94	125	150	200

For Type 0450.41, the KR 110 is also available.

Pitch $t = 45.0$ mm

Inside/Outside:

Not to be opened – $h_i = 28$ mm

Bend radii KR mm							
52	60	75	94	110	125	150	200

Pitch $t = 45.0$ mm

Type 0450

Load diagram

for unsupported length L_f depending on the additional load

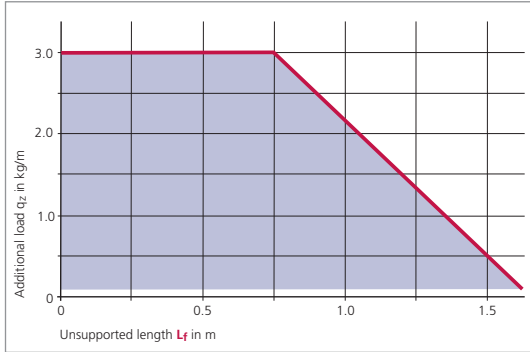

Unsupported length L_f

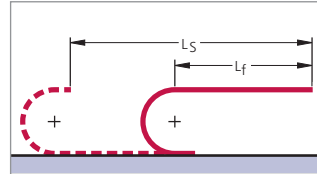

In the case of longer travel lengths, sag of the cable carriers is technically permissible depending on the application.

In a gliding arrangement, even longer travel lengths are possible (see page 295).

We are at your service to advise on these applications.

Example of ordering

Cable carrier			Divider system		Connection	
0450.61	-	94	-	900	TS 0 / 2	FA/MA
Chain type	Bend radius KR in mm	Chain length L_k in mm (without connection)	Divider system	Number of dividers n_T	Connection Fixed point/ Driver	

Ordering divider systems:

Please state the designation of the divider system (TS 0, TS 1 ...) and the number of dividers. Possibly attach a sketch with the dimensions.

Inside heights

24
-
28

Inside widths

38
-
103

kabelschlepp.de

Font:
+49 2762 4003-0

OnlineEngineer.de
with CableCarrier
Cable Carrier Configurator

Guide channels
► from page 295



Strain relief devices
► from page 302



Cables for cable carrier systems
► from page 344



Type 0450

Divider system TS 0

For types not to be opened – $h_i = 24 \text{ mm}$

Type	S_T mm	a_T min mm	a_x min mm
0450	2.5	13.5	9

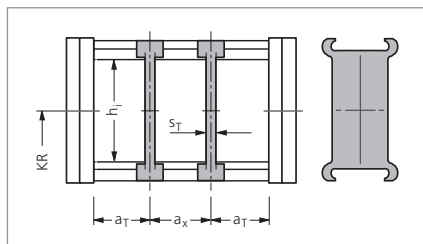

In the standard version, the divider systems are mounted on every second chain link.

Inside
heights



Inside
widths



For types not to be opened – $h_i = 28 \text{ mm}$

Type	S_T mm	a_T min mm	a_x min mm
0450	4.2	4.0	7.8

For types with hinged, openable and detachable brackets – $h_i = 24 \text{ mm}$

Type	S_T mm	a_T min mm	a_x min mm
0450	2.5	4.0	8.0

The dividers can be moved in the cross section.

Divider system TS 1 with continuous height subdivision made of plastic

For types not to be opened – $h_i = 28 \text{ mm}$

Type	S_T mm	S_H mm	a_T min mm	a_x min mm
0450	4.2	4	4.0	7.8

The dividers can be moved in the cross section.

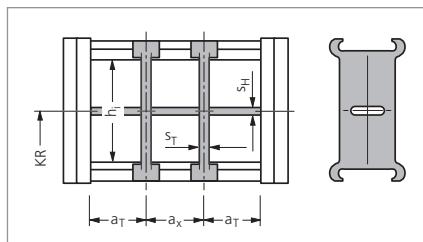

In the standard version, the divider systems are mounted on every second chain link.

Divider system TS 2 with grid subdivision made of plastic (4 mm grid)

For types not to be opened – $h_i = 28 \text{ mm}$

Type	S_T mm	S_H mm	a_T min mm	a_x min mm
0450	4.2	4	4.0	7.8

The dividers are fixed by the height separations, the complete divider system is movable.

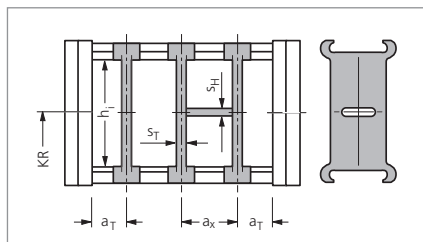

In the standard version, the divider systems are mounted on every second chain link.

Type 0450

Connection dimensions

Plastic connectors
with integrated strain relief

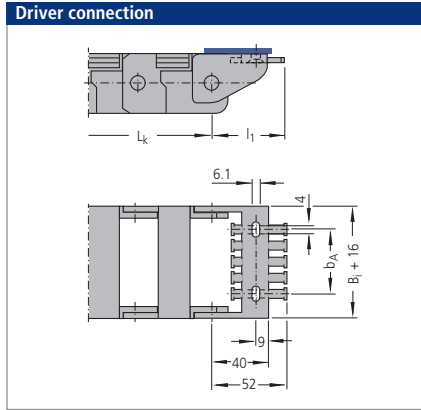
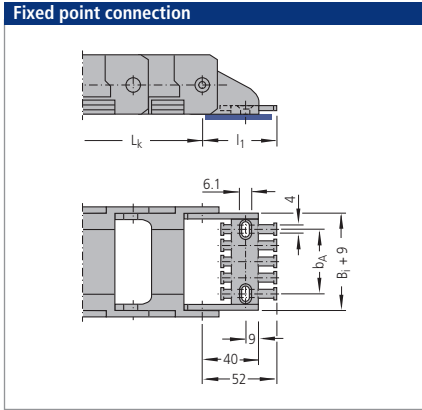

Inside heights



Inside widths



Type	B _i mm	B _k mm	b _A mm	n _Z
0450.20/.21/.22	38	54	24	3
0450.40/.41/.42	58	74	44	5
0450.60/.61/.62	78	94	64	7
0450.81/.82/.85	103	119	89	9

kabelschlepp.de

Connection variants

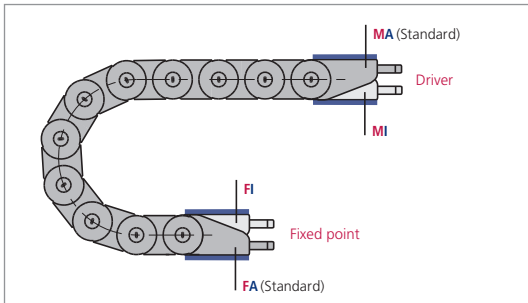

Connection point

- M** – Driver
- F** – Fixed point

Connection type

- A** – Threaded joint outside (standard)
- I** – Threaded joint inside

Font:
+49 2762 4003-0

In the standard version, the connectors are mounted with the threaded joint outwards (**FA/MA**).

When ordering please specify the desired connection type (see ordering key on page 332).

The connection type can subsequently be altered simply by varying the connectors.

Type 0625

Inside heights



Inside widths



kabelschlepp.de

Fon: +49 2762 4003-0

Use our free project planning service.

Inside/Outside: Not to be opened

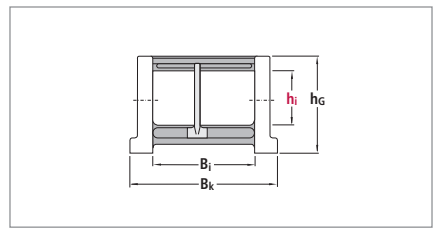
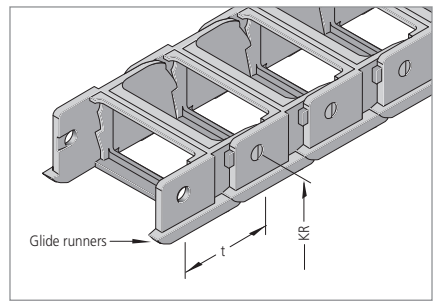

Outside: Hinged, openable and detachable brackets

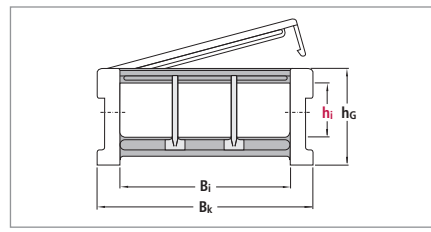
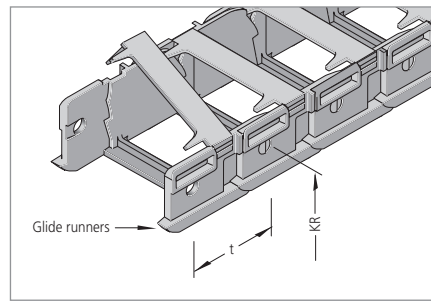

Dimensions and intrinsic chain weight

Inside/Outside: Not to be opened

Type	h_i mm	h_G mm	B_i mm	B_k mm	Intrinsic chain weight kg/m
0625.22	34	62	65	93	1.55
0625.40	34	56	108	126	1.40
0625.42	34	62	108	136	1.70

Injection moulded glide runners not for type 0625.40

Outside: Hinged, openable and detachable brackets

Type	h_i mm	h_G mm	B_i mm	B_k mm	Intrinsic chain weight kg/m
0625.23	34	62	65	93	1.55
0625.43	34	62	108	136	1.70
0625.25	42	62	65	93	1.74
0625.45	42	62	108	136	2.06
0625.55	42	62	125	153	2.07
0625.65	42	62	150	178	2.15
0625.75	42	62	169	197	2.37

Bend radius and pitch

Inside/Outside: Not to be opened

Bend radii KR mm				
75*	90	125	200	300

* Not for type 0625.22

Pitch t = 62.5 mm

Outside: Hinged, openable and detachable brackets

Bend radii KR mm				
90	125	150	200	250 300

For type 0625.43, KR 75 mm is also available

Pitch t = 62.5 mm

Type 0625

Load diagram

for unsupported length L_f depending on the additional load

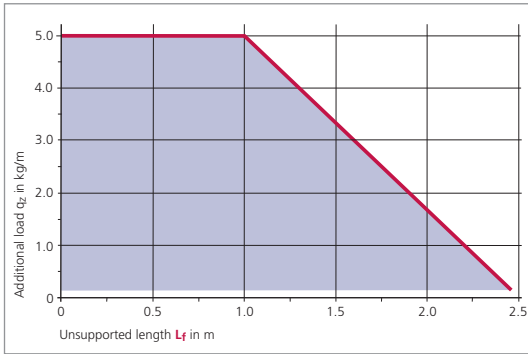

Unsupported length L_f

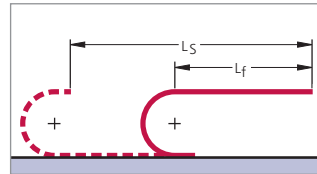

In the case of longer travel lengths, sag of the cable carriers is technically permissible depending on the application.

In a gliding arrangement, even longer travel lengths are possible (see page 295).

We are at your service to advise on these applications.

Inside heights

34
-
42

Inside widths

65
-
169

Example of ordering

Cable carrier

0625.65 - 125 - 1250
Chain type Bend radius Chain length L_k
KR in mm in mm (without connection)

Divider system

TS 0 / 2
Divider system Number of dividers n_T

Connection

FA/MA
Connection Fixed point/Driver

Ordering divider systems:

Please state the designation of the divider system (TS 0, TS 1 ...) and the number of dividers. Possibly attach a sketch with the dimensions.

kabelschlepp.de

Font: +49 2762 4003-0

OnlineEngineer.de
With CableCarrier
Cable Carrier Configurator

Guide channels
➤ from page 295

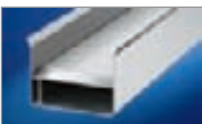

Strain relief devices
➤ from page 302



Cables for cable carrier systems
➤ from page 344



Type 0625

Divider system TS 0

Inside heights

34
—
42

Inside widths

65
—
169

Type	h_i mm	S_T mm	a_T min mm	a_x min mm
0625.22	34	3.5	6.0	12
0625.40				
0625.42				
0625.23	34	3.5	10.0	12
0625.43				
0625.25	42	4.0	11.0	11
0625.45				
0625.55				
0625.65				
0625.75				

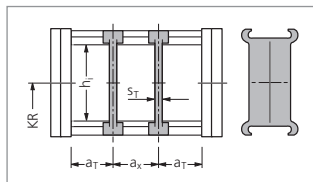

In the standard version, the divider systems are mounted on every second chain link.

The dividers can be moved in the cross section.

kabelschlepp.de

Divider system TS 1 with continuous height subdivision made of aluminium

Type	h_i mm	S_T mm	a_T min mm	a_x min mm	S_H mm	h_1 mm
0625.25	42	4	11	11	2	15
0625.45						
0625.55						
0625.65						
0625.75						

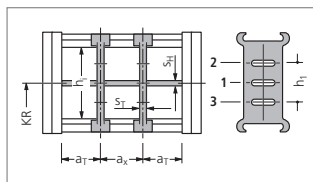

The dividers can be moved in the cross section.

In the standard version, the divider systems are mounted on every second chain link.

Height separation in Position 1 – 3 possible.

Fon: +49 2762 4003-0

Divider system TS 2 with grid subdivision made of aluminium (1 mm grid)

Type	h_i mm	S_T mm	a_T min mm	a_x min mm	S_H mm	h_1 mm
0625.25	42	6	12	20	4	15
0625.45						
0625.55						
0625.65						
0625.75						

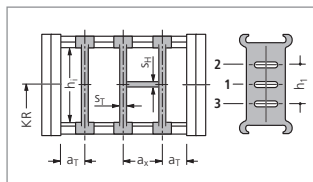

The dividers are fixed by the height separations, the complete divider system is movable.

In the standard version, the divider systems are mounted on every second chain link.

Use our free project planning service.

Type 0625

Connection dimensions

Standard end connector made of steel

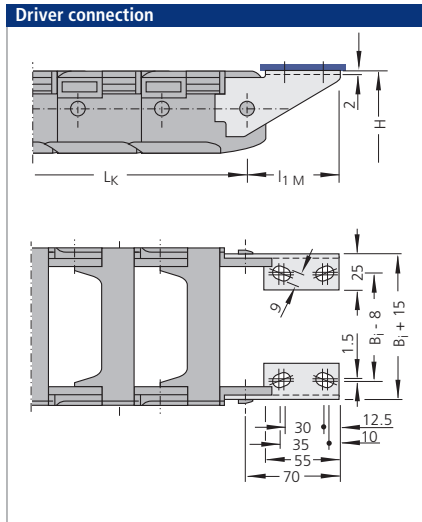
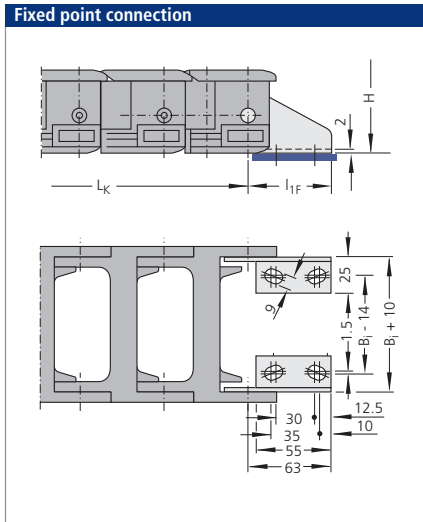

Connecting surface on the outside
(not illustrated) possible on request.

Inside heights

34
-
42

Inside widths

65
-
169

kabelschlepp.de

Connectors with integrated strain relief are available. Please do get in touch with us.

Connection variants

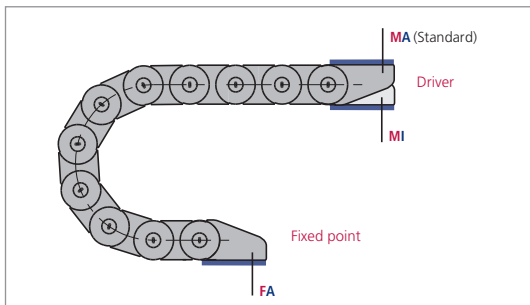

Connection point

- M** – Driver
- F** – Fixed point

Connection type

- A** – Threaded joint outside (standard)
- I** – Threaded joint inside

In the standard version, the connectors are mounted with the threaded joint outwards (**FA/MA**).

When ordering please specify the desired connection type (see ordering key on page 332).

The connection type can subsequently be altered simply by varying the connectors.

Subject to change.

Font:
+49 2762 4003-0

OnlineEngineer.de
KABELSCHLEPP
Cable Chain Configurator